

GENERAL NOTES:

1. REMOVE TREES OUTSIDE THE CLEARING LIMIT WHEN, IN THE OPINION OF THE ENGINEER, THE UTILITY OF A TREE WILL BE DESTROYED BY THE CONSTRUCTION OR THE CLEARING OPERATION.
2. CLEAR IN ACCORDANCE WITH THIS STANDARD EXCEPT WHERE ADDITIONAL CLEARING IS REQUIRED FOR SAFETY AS SHOWN ON THE PLANS.
3. FOR SECTIONS WITH WIDE MEDIANS WHERE TREES ARE TO REMAIN, CLEAR THE MEDIAN SIDE IN THE SAME MANNER AS ON THE OUTSIDE.

CLEAR TO SLOPE STAKE LINE OR CONSTRUCTION LIMITS

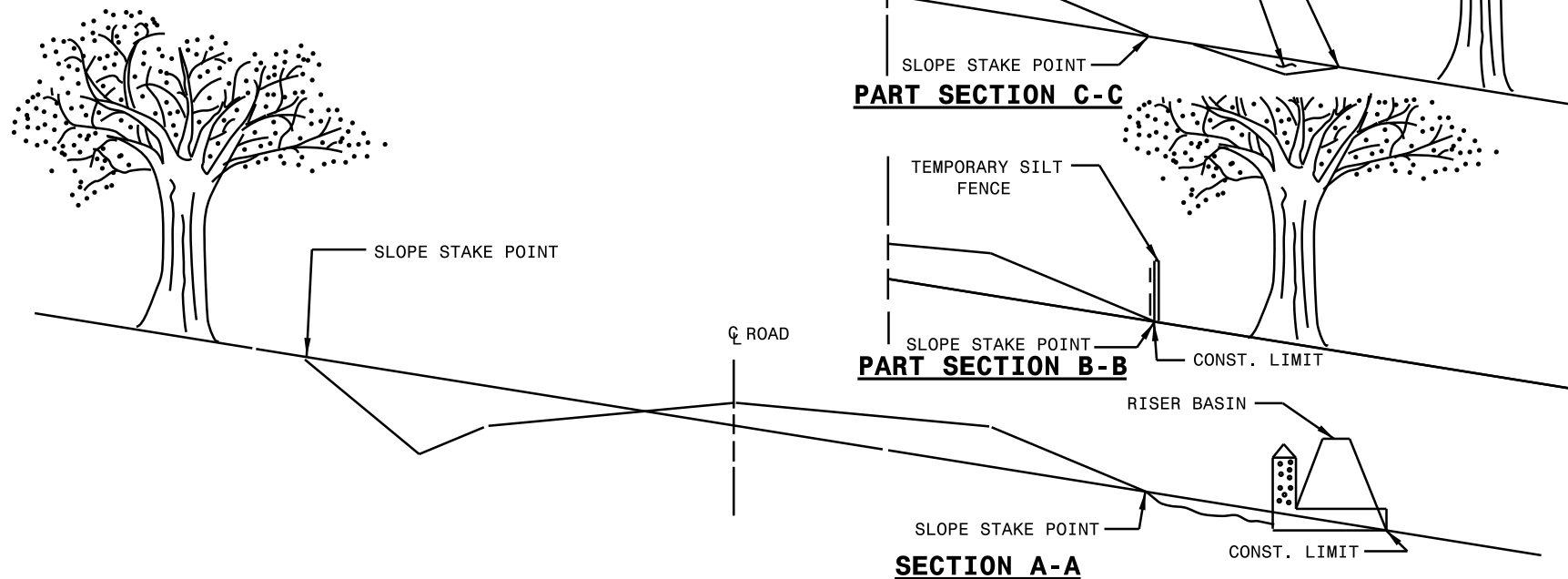

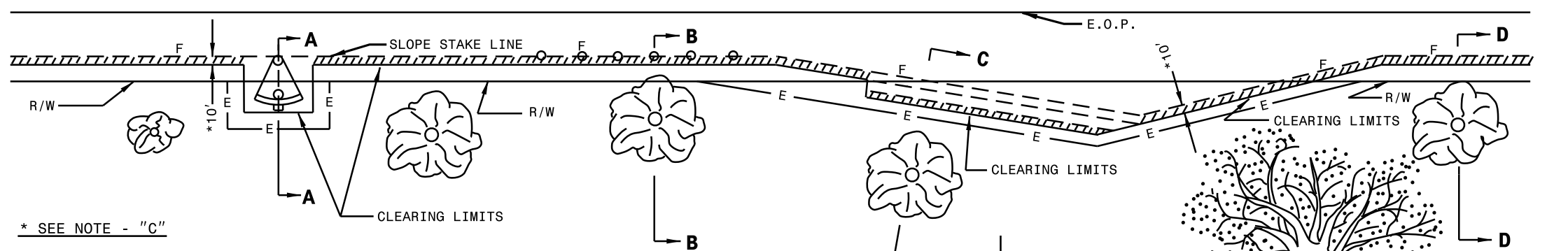
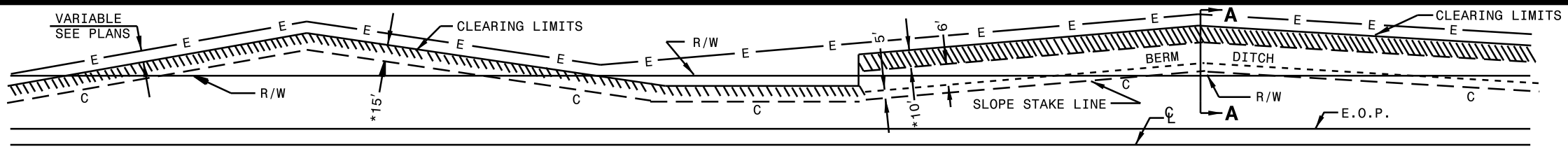

* SEE NOTE - "C"

GENERAL NOTES:

1. REMOVE TREES OUTSIDE THE CLEARING LIMIT WHEN, IN THE OPINION OF THE ENGINEER, THE UTILITY OF A TREE WILL BE DESTROYED BY THE CONSTRUCTION OR THE CLEARING OPERATION.
2. CLEAR IN ACCORDANCE WITH THIS STANDARD EXCEPT WHERE ADDITIONAL CLEARING IS REQUIRED FOR SAFETY AS SHOWN ON THE PLANS.

METHOD III CLEARING LIMITS

- (A) CUTS -- CLEAR TO 10' BEYOND CONSTRUCTION LIMITS.
- (B) FILLS -- CLEAR TO 10' BEYOND CONSTRUCTION LIMITS, UNLESS SPECIFIED OTHERWISE BY WETLAND PERMIT.
- (C) CUTS AND FILLS -- WHEN THE CLEARING LIMITS (A AND B) EXCEED THE PROPOSED R/W OR PROPOSED CONSTRUCTION EASEMENTS, THEN CLEAR ONLY TO THE R/W OR CONSTRUCTION EASEMENT WHICHEVER IS GREATER.

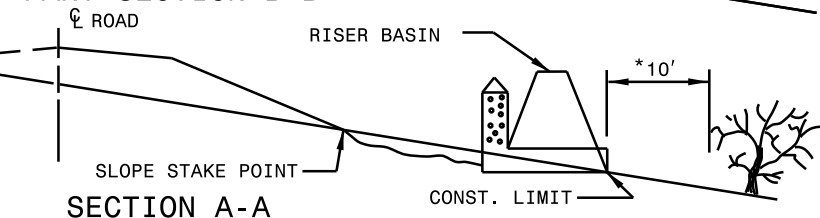
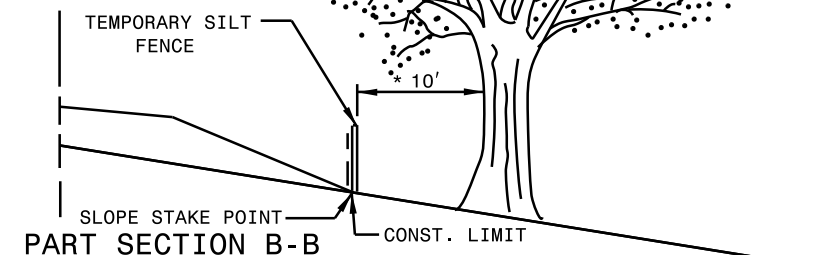
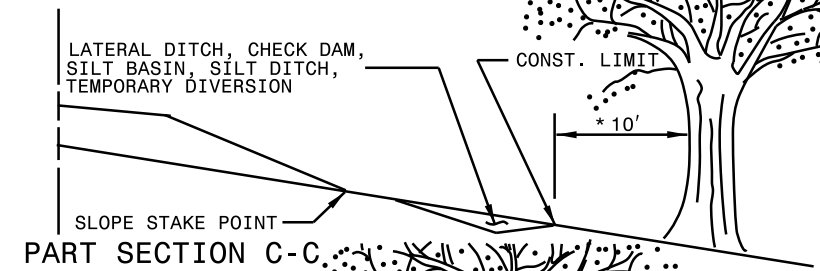
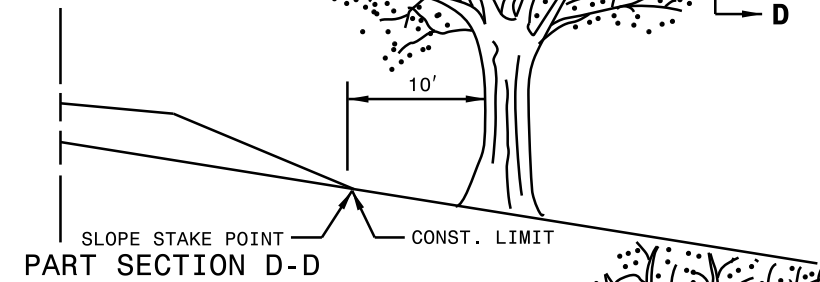
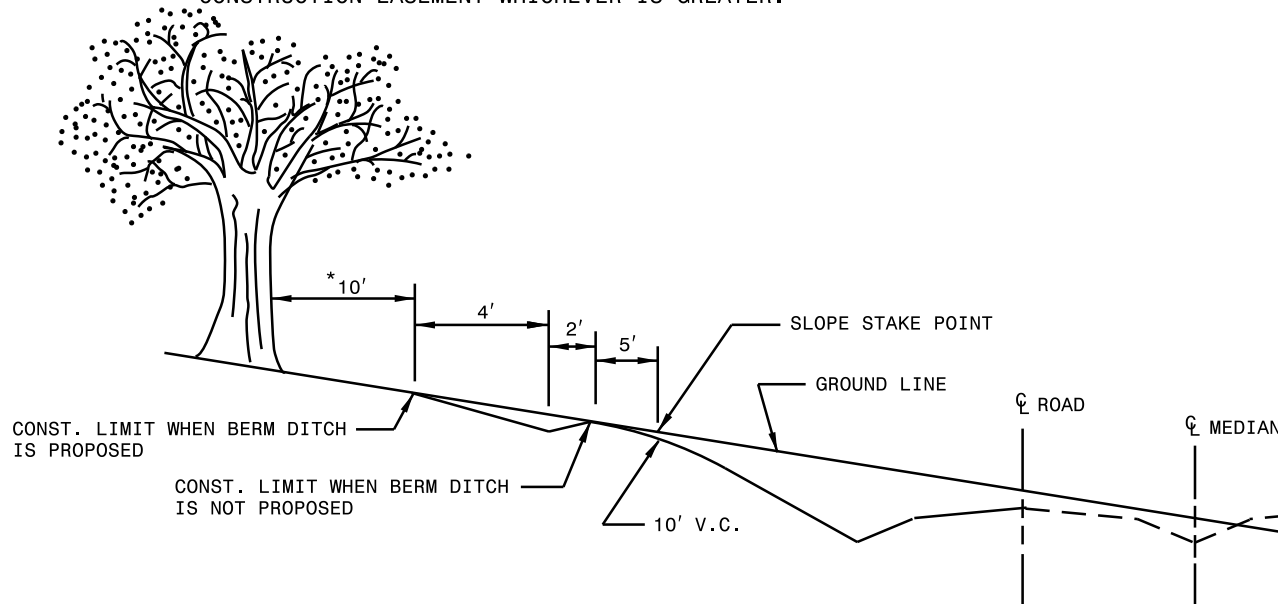

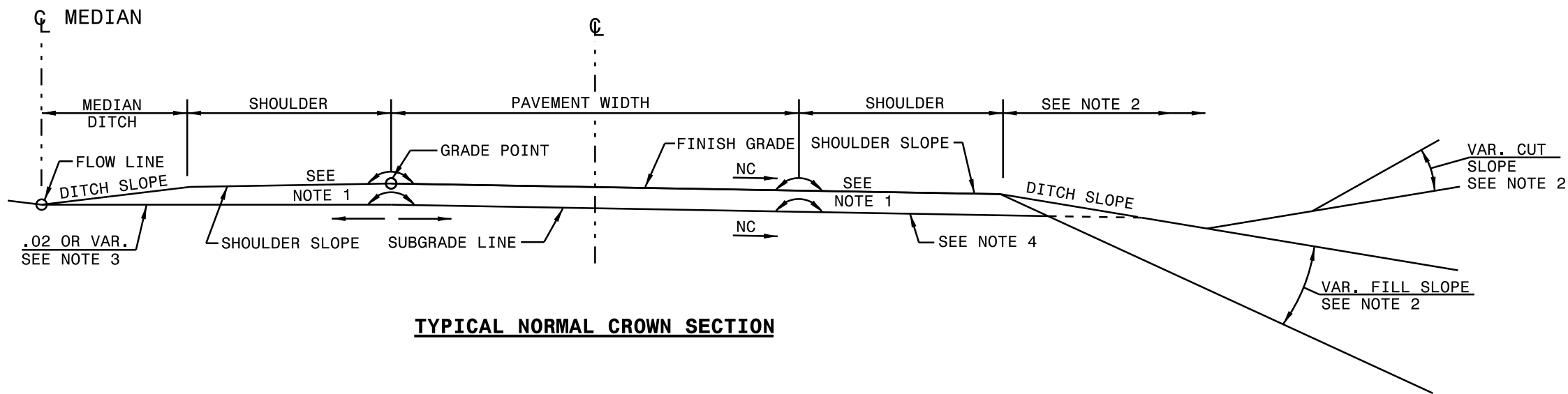

TYPICAL NORMAL CROWN SECTION

1. SEE TYPICAL SECTION FOR LATERAL LOCATION OF ROLLOVER.
2. SEE PLANS FOR METHOD OF CONSTRUCTING CUT AND FILL SLOPES.
3. SUBGRADE LINE WILL NOT UNDERCUT DITCH GRADE AT ANY POINT.
4. OUTSIDE SHOULDER SUBGRADES ARE THE SAME RATE OF SLOPE AS THE ADJACENT TRAVEL LANE SUBGRADES **UNLESS** CONSTRUCTED ON THE HIGH SIDE OF SUPERELEVATION OR CONSIST OF 10' AND WIDER FULL DEPTH PAVEMENT (SEE STDS. 560.01 AND 560.02).

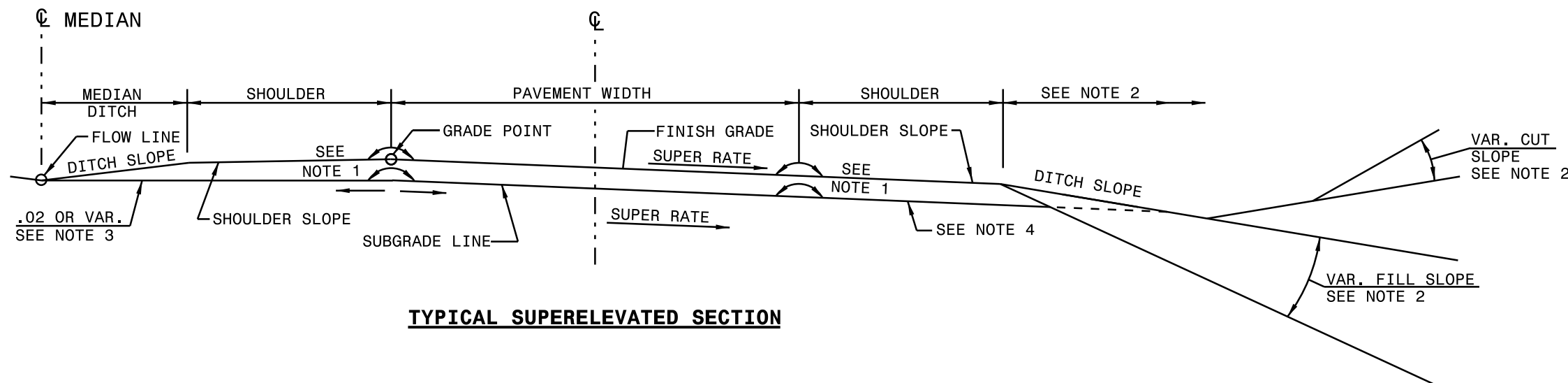

TYPICAL SUPERELEVATED SECTION

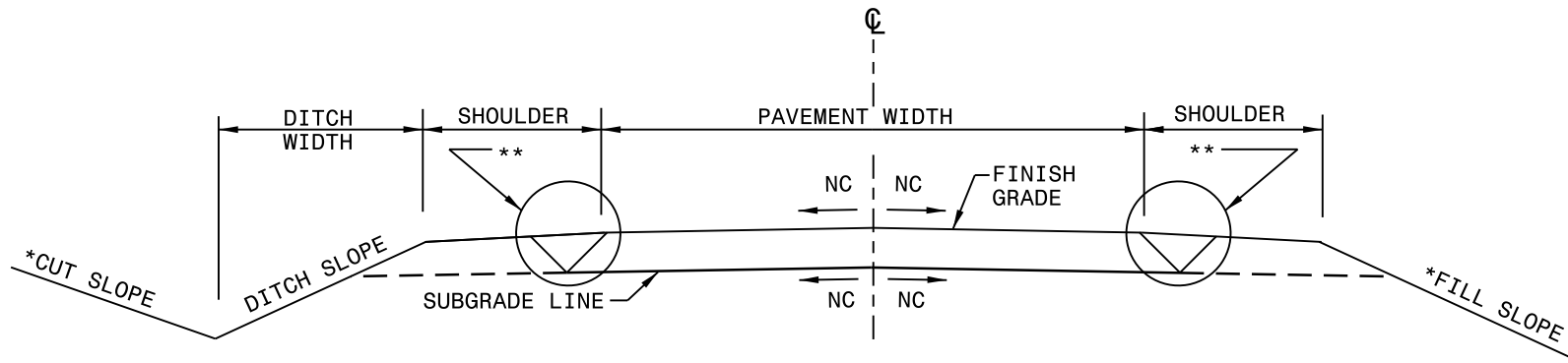

TYPICAL NORMAL CROWN SECTION

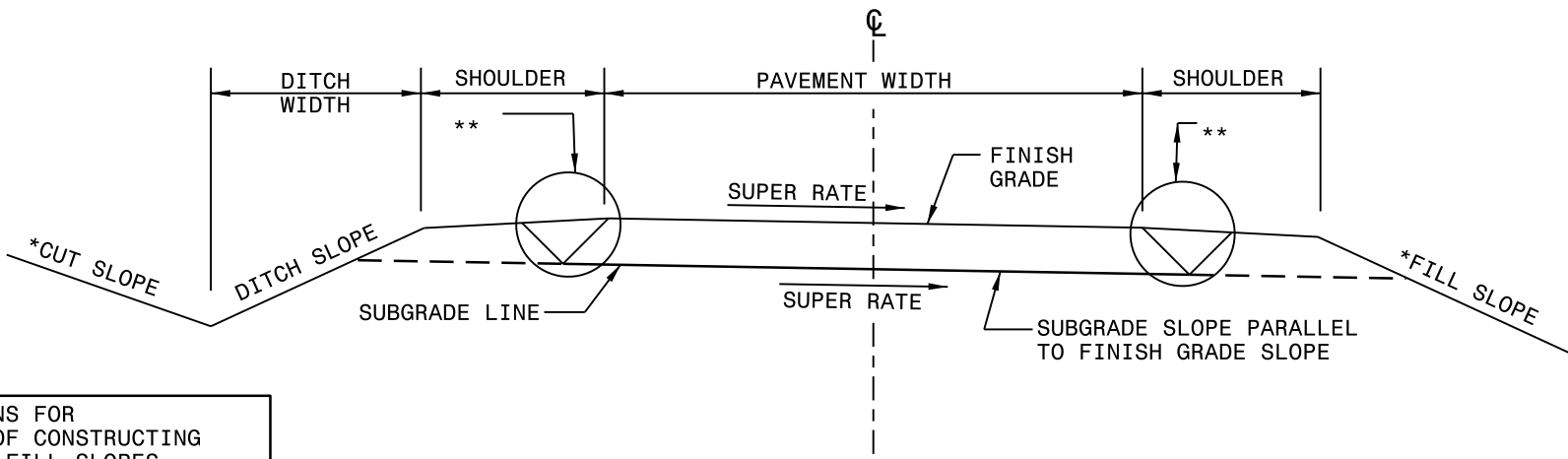

TYPICAL SUPERELEVATED SECTION

*SEE PLANS FOR METHOD OF CONSTRUCTING CUT AND FILL SLOPES.

** TRENCH OR GRADED SECTION. SEE PLANS.

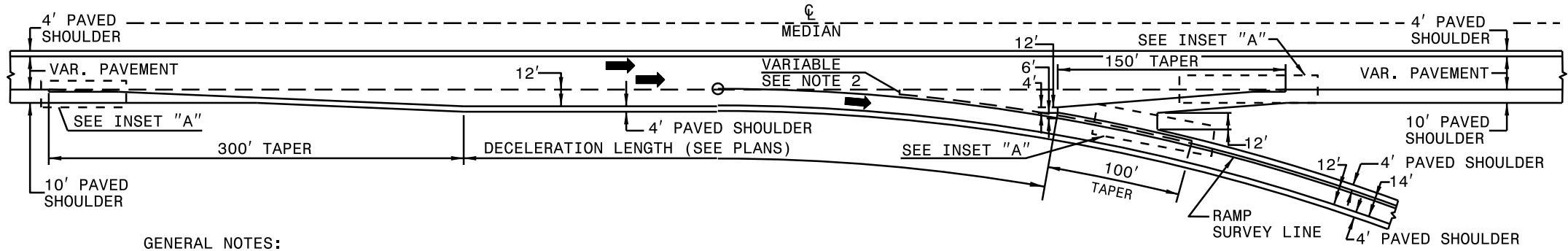

GENERAL NOTES:

IF PAVEMENT IS PORTLAND CEMENT CONCRETE:

1. THE LONGITUDINAL AND TRANSVERSE CONSTRUCTION JOINTS WILL BE LOCATED AS DENOTED BY THE DASHED LINES.
2. FORM THE TRANSVERSE CONSTRUCTION JOINT IN LINE WITH WITH THE NEAREST EXISTING TRANSVERSE CONTRACTION JOINT IN THE THROUGH LANE PAVEMENT. THE DISTANCE ALONG THIS CONSTRUCTION JOINT WILL BE NO LESS THAN TWO FEET AND NO GREATER THAN FOUR FEET.

PARALLEL EXIT

FLEXIBLE OR RIGID PAVEMENT
INTERSTATE

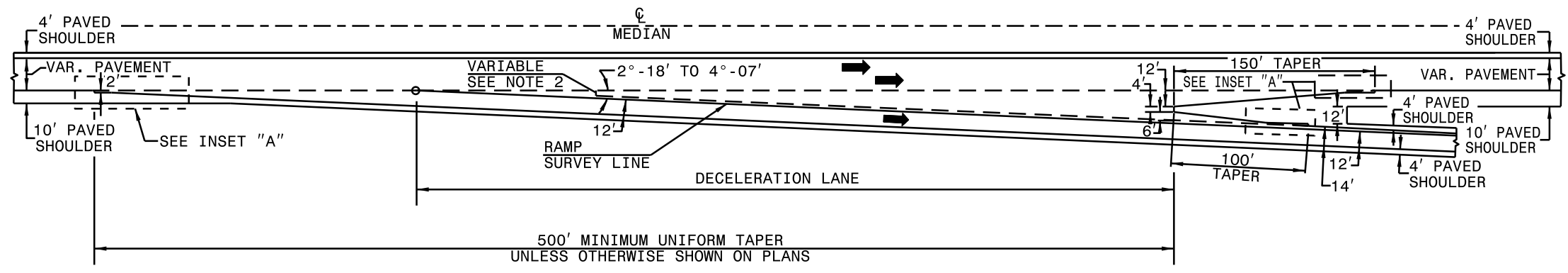

ANGULAR EXIT

FLEXIBLE OR RIGID PAVEMENT
INTERSTATE

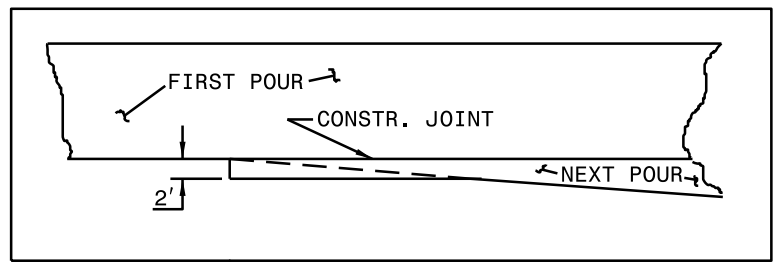

INSET "A"

DETAIL OF CONCRETE
TAPER CONSTRUCTION

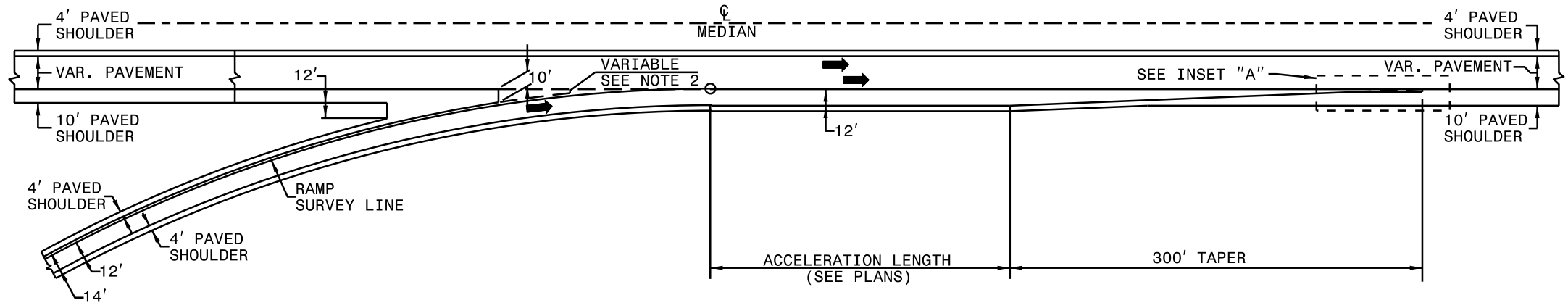

PARALLEL ENTRANCE
FLEXIBLE OR RIGID PAVEMENT
INTERSTATE

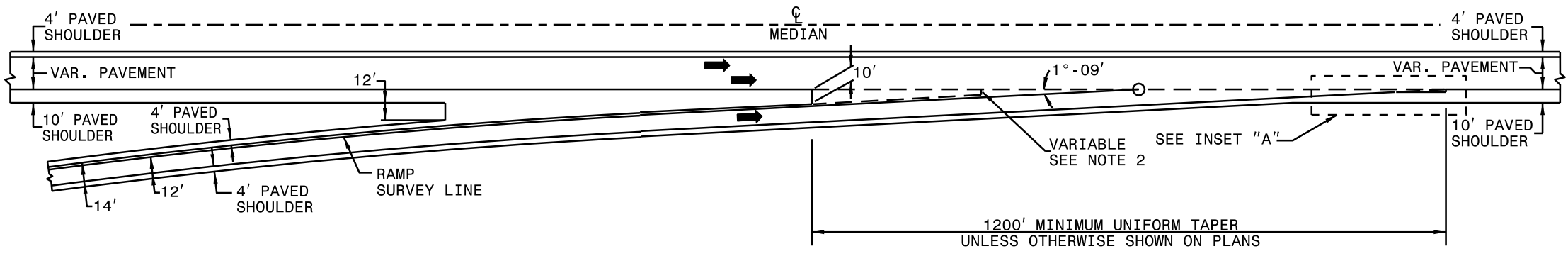

ANGULAR ENTRANCE
FLEXIBLE OR RIGID PAVEMENT
INTERSTATE

GENERAL NOTES:

- IF PAVEMENT IS PORTLAND CEMENT CONCRETE:
1. THE LONGITUDINAL AND TRANSVERSE CONSTRUCTION JOINTS WILL BE LOCATED AS DENOTED BY THE DASHED LINES.
 2. FORM THE TRANSVERSE CONSTRUCTION JOINT IN LINE WITH THE NEAREST EXISTING TRANSVERSE CONTRACTION JOINT IN THE THROUGH LANE PAVEMENT. THE DISTANCE ALONG THIS CONSTRUCTION JOINT WILL BE NO LESS THAN TWO FEET AND NO GREATER THAN FOUR FEET.

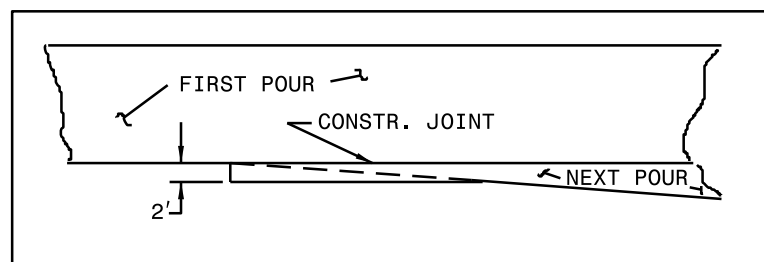

INSET "A"
DETAIL OF CONCRETE
TAPER CONSTRUCTION

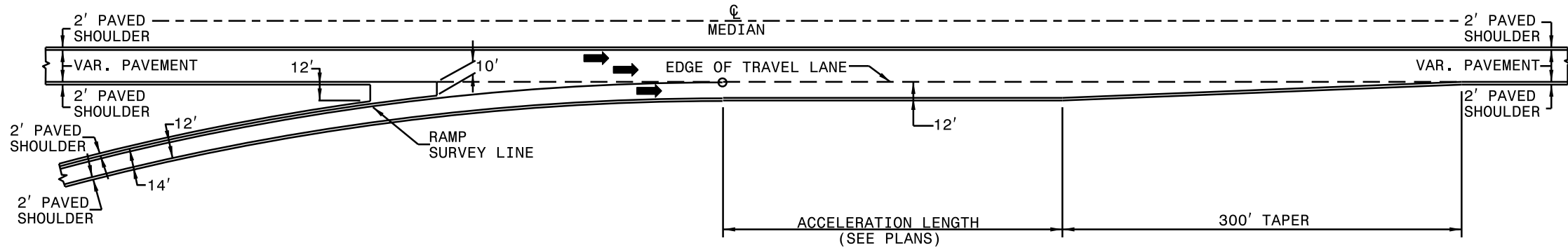

PARALLEL ENTRANCE

FLEXIBLE PAVEMENT
NON-INTERSTATE

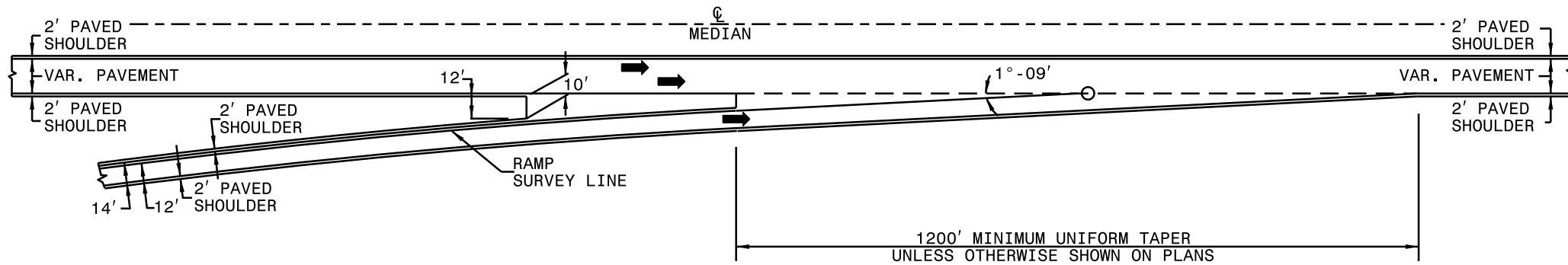

ANGULAR ENTRANCE

FLEXIBLE PAVEMENT
NON-INTERSTATE

1-24

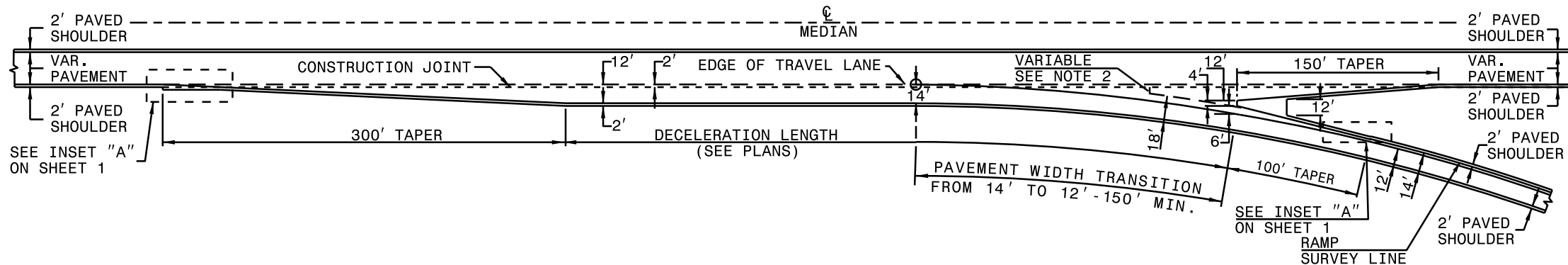

PARALLEL EXIT

RIGID PAVEMENT

NON-INTERSTATE

GENERAL NOTES:

IF PAVEMENT IS PORTLAND CEMENT CONCRETE:

1. THE LONGITUDINAL AND TRANSVERSE CONSTRUCTION JOINTS WILL BE LOCATED AS DENOTED BY THE DASHED LINES.
2. FORM THE TRANSVERSE CONSTRUCTION JOINT IN LINE WITH THE NEAREST EXISTING TRANSVERSE CONTRACTION JOINT IN THE THROUGH LANE PAVEMENT. THE DISTANCE ALONG THIS CONSTRUCTION JOINT WILL BE NO LESS THAN TWO FEET AND NO GREATER THAN FOUR FEET.

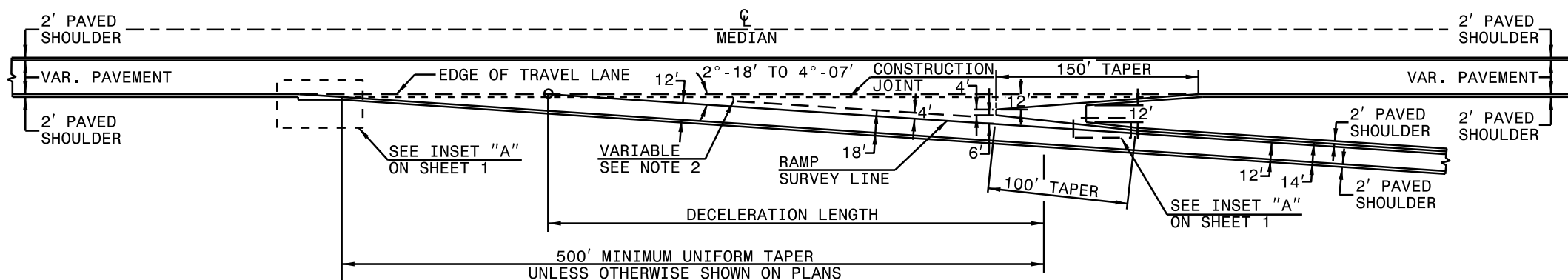

ANGULAR EXIT

RIGID PAVEMENT

NON-INTERSTATE

1-24

ROADWAY STANDARD DRAWING FOR

DECELERATION AND ACCELERATION LANES

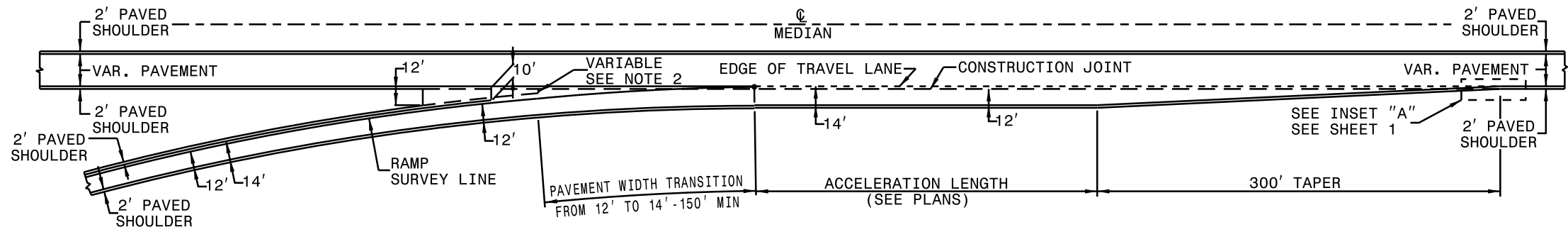

PARALLEL ENTRANCE
RIGID PAVEMENT
NON-INTERSTATE

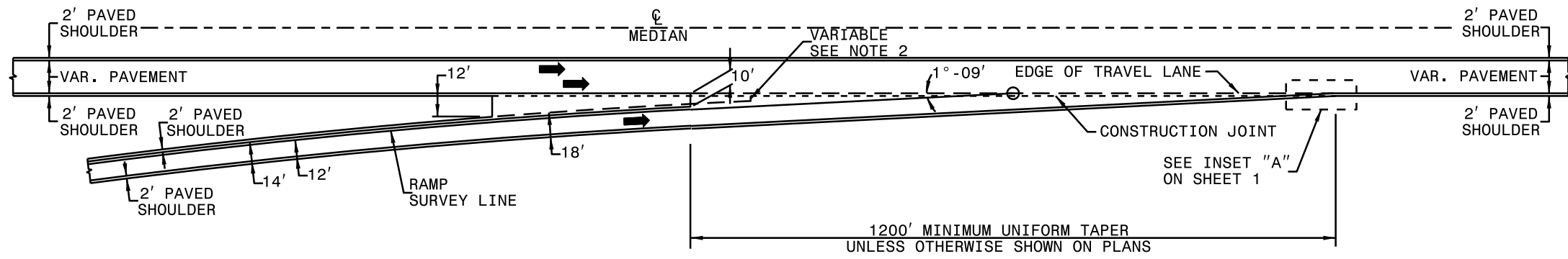

ANGULAR ENTRANCE
RIGID PAVEMENT
NON-INTERSTATE

GENERAL NOTES:

- IF PAVEMENT IS PORTLAND CEMENT CONCRETE:
1. THE LONGITUDINAL AND TRANSVERSE CONSTRUCTION JOINTS WILL BE LOCATED AS DENOTED BY THE DASHED LINES.
 2. FORM THE TRANSVERSE CONSTRUCTION JOINT IN LINE WITH THE NEAREST EXISTING TRANSVERSE CONTRACTION JOINT IN THE THROUGH LANE PAVEMENT. THE DISTANCE ALONG THIS CONSTRUCTION JOINT WILL BE NO LESS THAN TWO FEET AND NO GREATER THAN FOUR FEET.

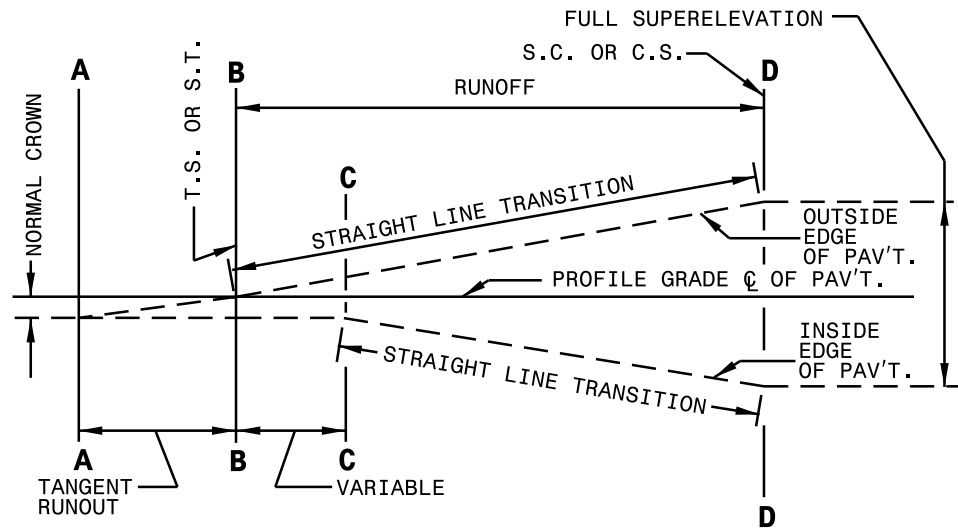

NOTE:
SHORT VERTICAL CURVES 100' OR LESS MAY BE INSERTED AT POINTS C & D WHEN DIRECTED DURING CONSTRUCTION.

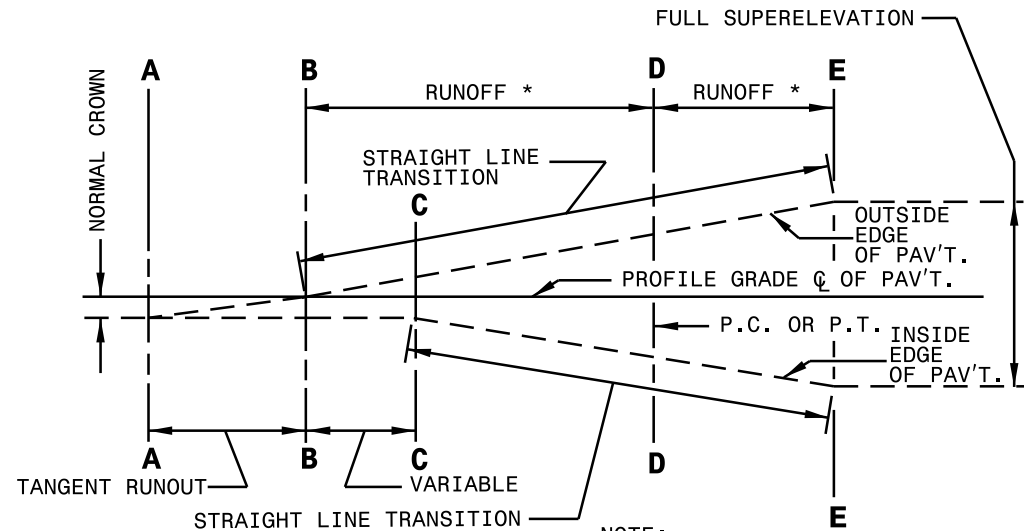

NOTE:
SHORT VERTICAL CURVES 100' OR LESS MAY BE INSERTED AT POINTS C & E WHEN DIRECTED DURING CONSTRUCTION.

GENERAL NOTES:

SPECIAL CARE MUST BE USED TO PREVENT DITCH SUMPS WHICH MIGHT BE INDUCED BY SUPERELEVATION.

TANGENT RUNOFF DISTANCE WILL VARY WITH NORMAL CROWN OF PAVEMENT WITHIN TANGENT RUNOUT-DISTANCE.

FULL SUPERELEVATION TO BE AS PROVIDED IN "A POLICY ON GEOMETRIC DESIGN OF HIGHWAYS AND STREETS".

* DISTRIBUTION OF RUNOFF TO BE AS PROVIDED IN "A POLICY ON GEOMETRIC DESIGN OF HIGHWAYS AND STREETS".

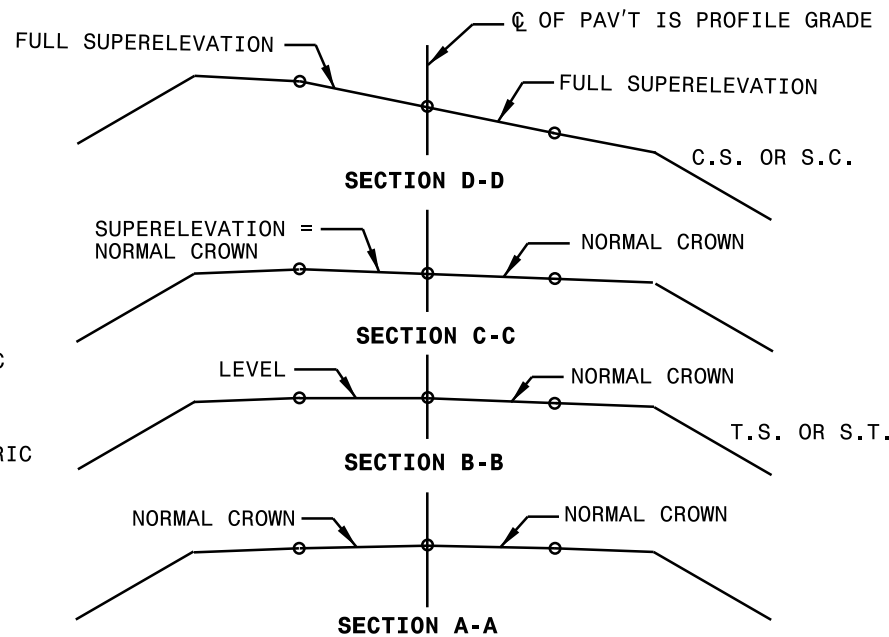

FIGURE-1 SPIRAL CURVE

2-LANE PAVEMENT PROFILE GRADE ON \mathcal{C} OF PAVEMENT. CROWN BOTH WAYS FROM \mathcal{C} ROTATE ABOUT \mathcal{C} .

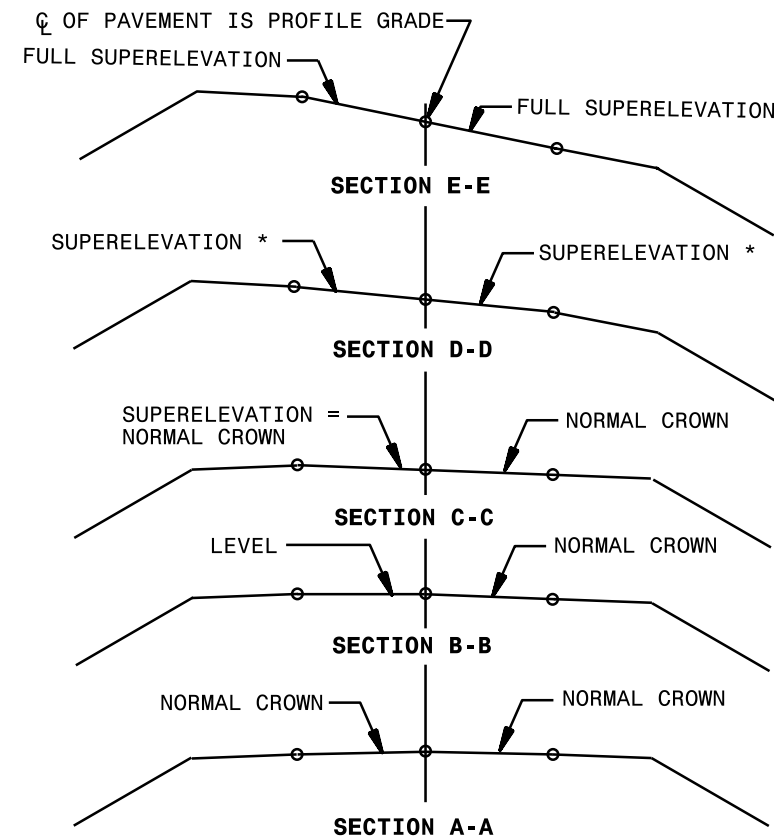

FIGURE 2 - SIMPLE CURVE

2-LANE PAVEMENT WITHOUT TRANSITION PROFILE GRADE ON \mathcal{C} PAVEMENT. SLOPE BOTH WAYS FROM \mathcal{C} ROTATE ABOUT \mathcal{C} .

1-24

ROADWAY STANDARD DRAWING FOR

METHOD OF OBTAINING SUPERELEVATION
TWO LANE PAVEMENT

SHEET 1 OF 1

225.04

STATE OF
NORTH CAROLINA
DEPT. OF TRANSPORTATION
DIVISION OF HIGHWAYS
RALEIGH, N.C.

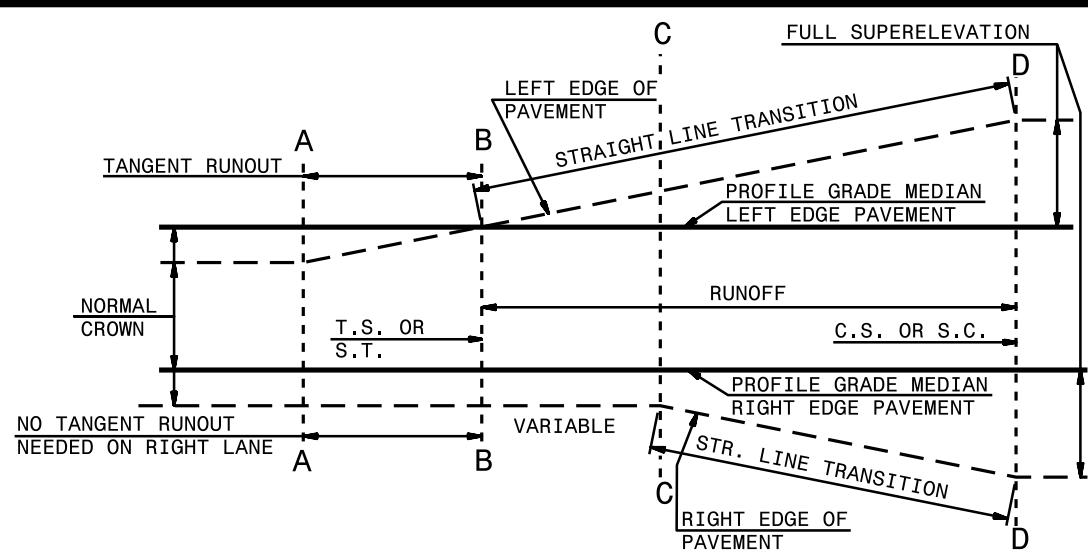

SHORT VERTICAL CURVES 100' OR LESS MAY BE INSERTED AT POINTS C AND D WHEN DIRECTED ON CONSTRUCTION

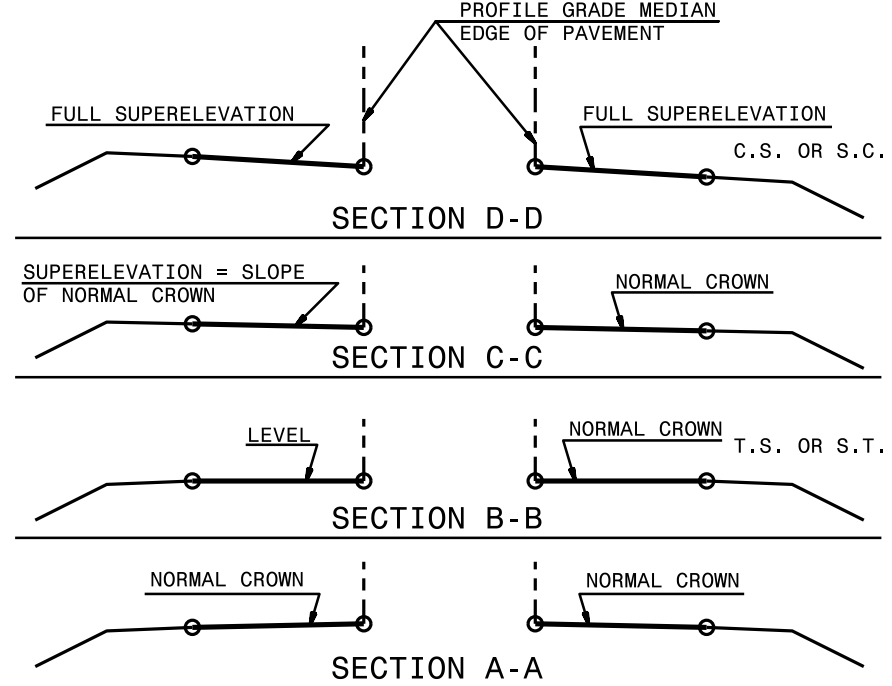
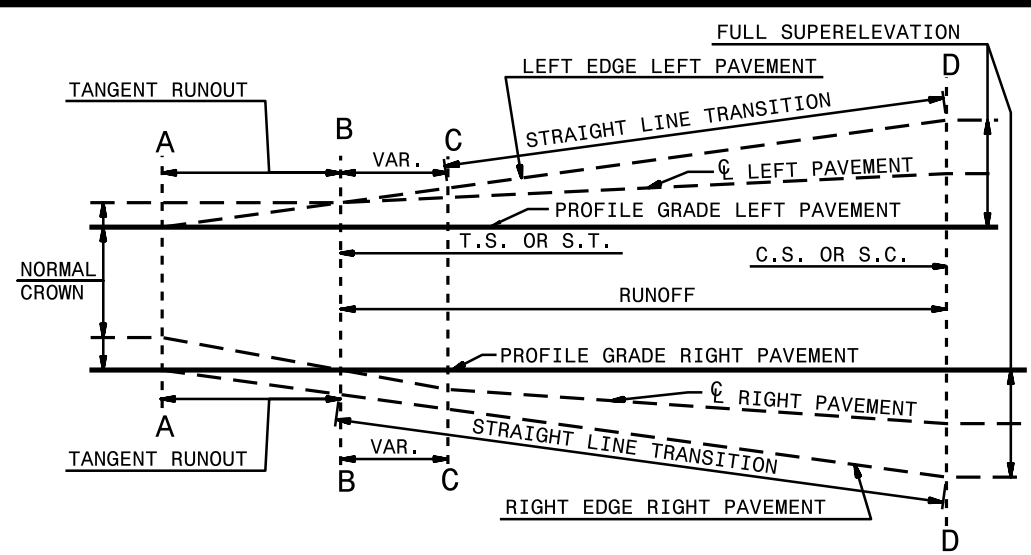

FIGURE 1 SPIRAL CURVE

4 LANE PAVEMENT
PROFILE GRADE ON MEDIAN EDGE OF PAVEMENT. SLOPE BOTH WAYS FROM MEDIAN, ROTATE ABOUT MEDIAN.

GENERAL NOTES:

- SUPERELEVATION TO BE AS PROVIDED IN ROADWAY DESIGN MANUAL.
- SPECIAL CARE MUST BE USED TO PREVENT DITCH SUMPS WHICH MIGHT BE INDUCED BY SUPERELEVATION.
- PROFILE GRADE WILL BE MEDIAN EDGE OF PAVEMENT ON BOTH TANGENTS AND CURVES.
- IN WIDE MEDIANS, WHERE INDIVIDUAL ALIGNMENT IS USED, PROFILE GRADE WILL REMAIN ON MEDIAN EDGE OF PAVEMENT.



SHORT VERTICAL CURVES 100' OR LESS MAY BE INSERTED AT POINT D WHEN DIRECTED ON CONSTRUCTION

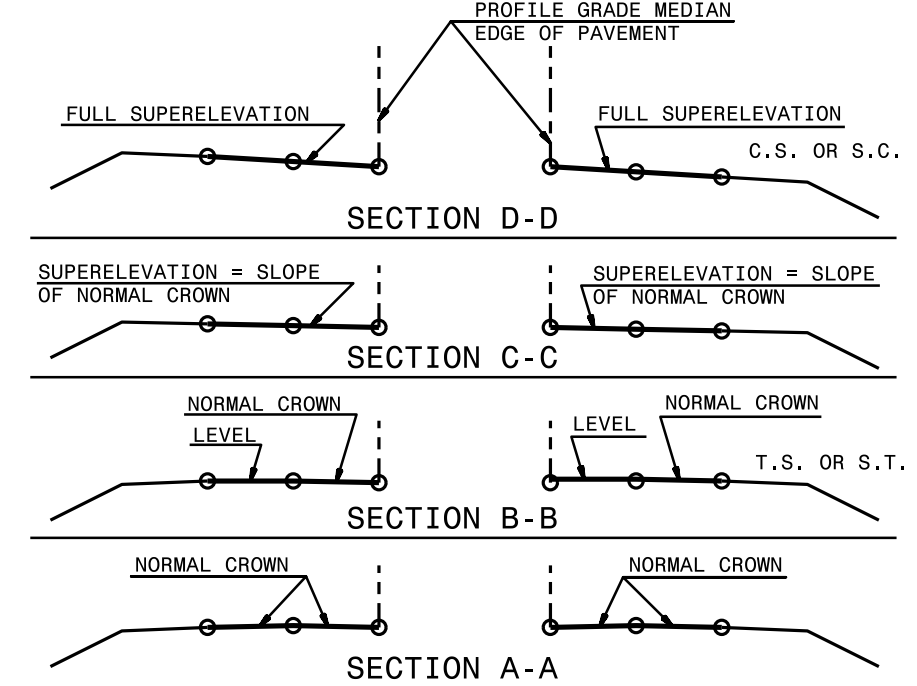

FIGURE 2 SIMPLE CURVE OR SPIRAL CURVE

4 LANE PAVEMENT
PROFILE GRADE MEDIAN EDGE OF PAVEMENT. CROWNED ABOUT CENTER OF PAVEMENTS, ROTATE ABOUT MEDIAN EDGES

GENERAL NOTES:

USE THIS GRADING GUIDE AT GRADE SEPARATIONS WITH FALSE CUT APPROACH.

IF STRUCTURE HAS OUTSIDE PIERS, ELIMINATE THE 6' VERTICAL CURVE.

D - TYPICAL DITCH WIDTH

* - SEE ROADWAY TYPICAL SECTIONS FOR NORMAL SHOULDER WIDTHS, SHOULDER SLOPES, AND DITCH WIDTHS.

** - SEE ROADWAY PLANS AND/OR STRUCTURE PLANS FOR VARIABLE OFFSET.

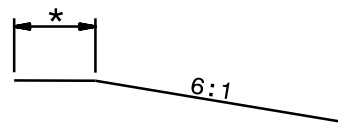
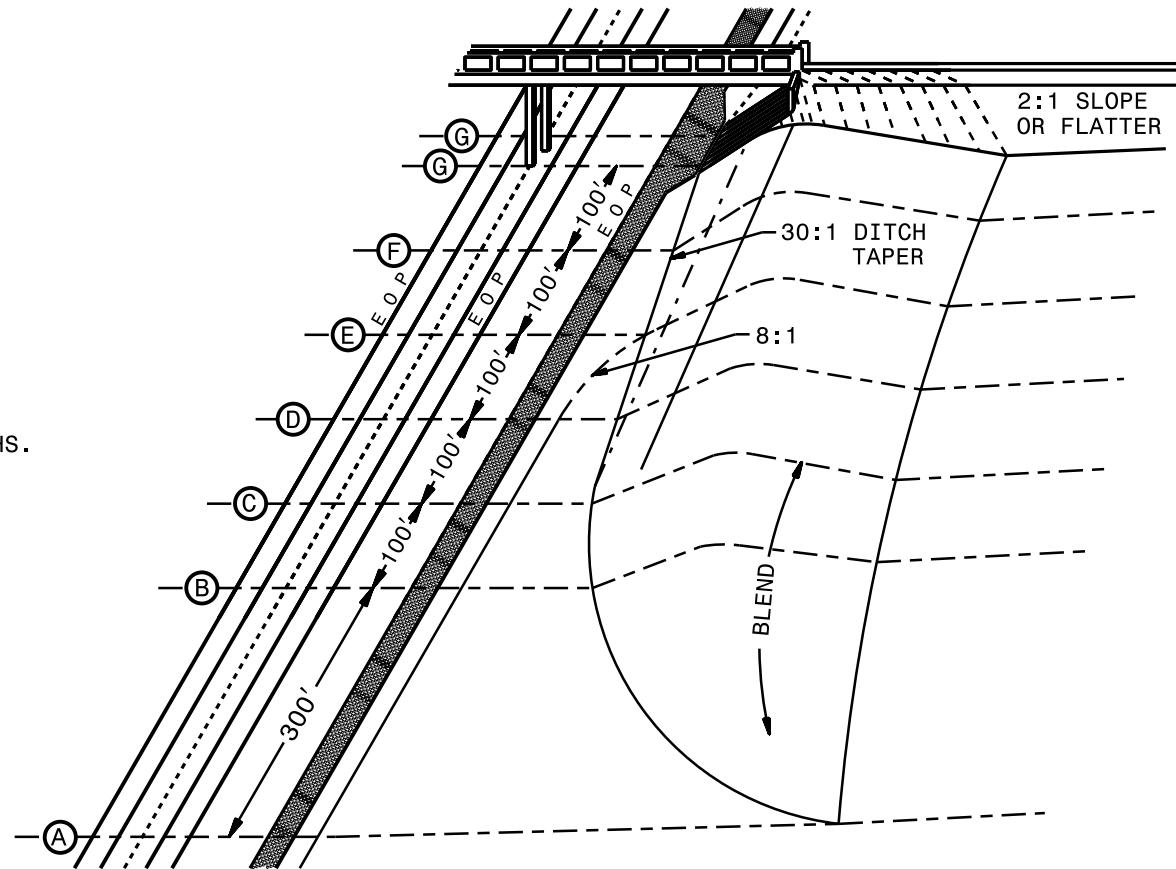

SECTION A

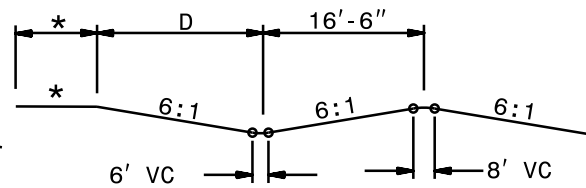

SECTION B

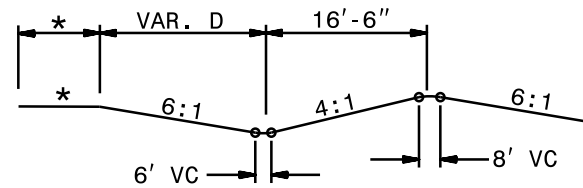

SECTION C

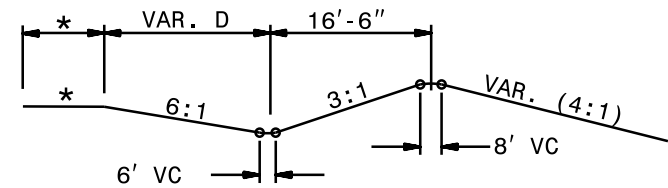

SECTION D

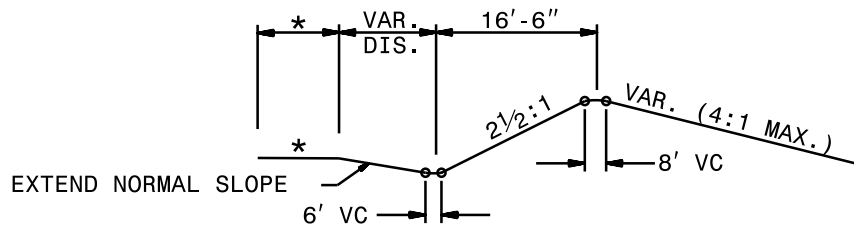

SECTION E

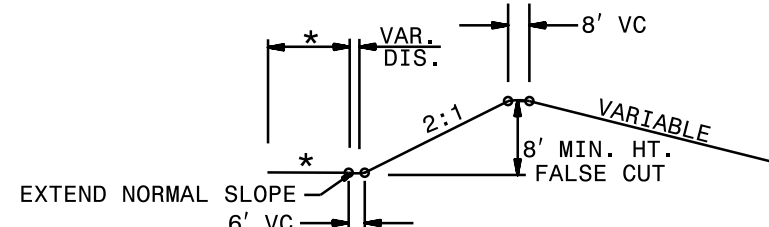

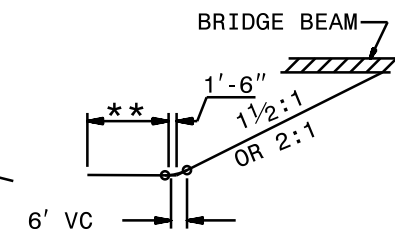

SECTION F



SECTION G

LEGEND

PAVED SHOULDER 

4" CONCRETE SLOPE PROTECTION (ROADWAY ITEM) 

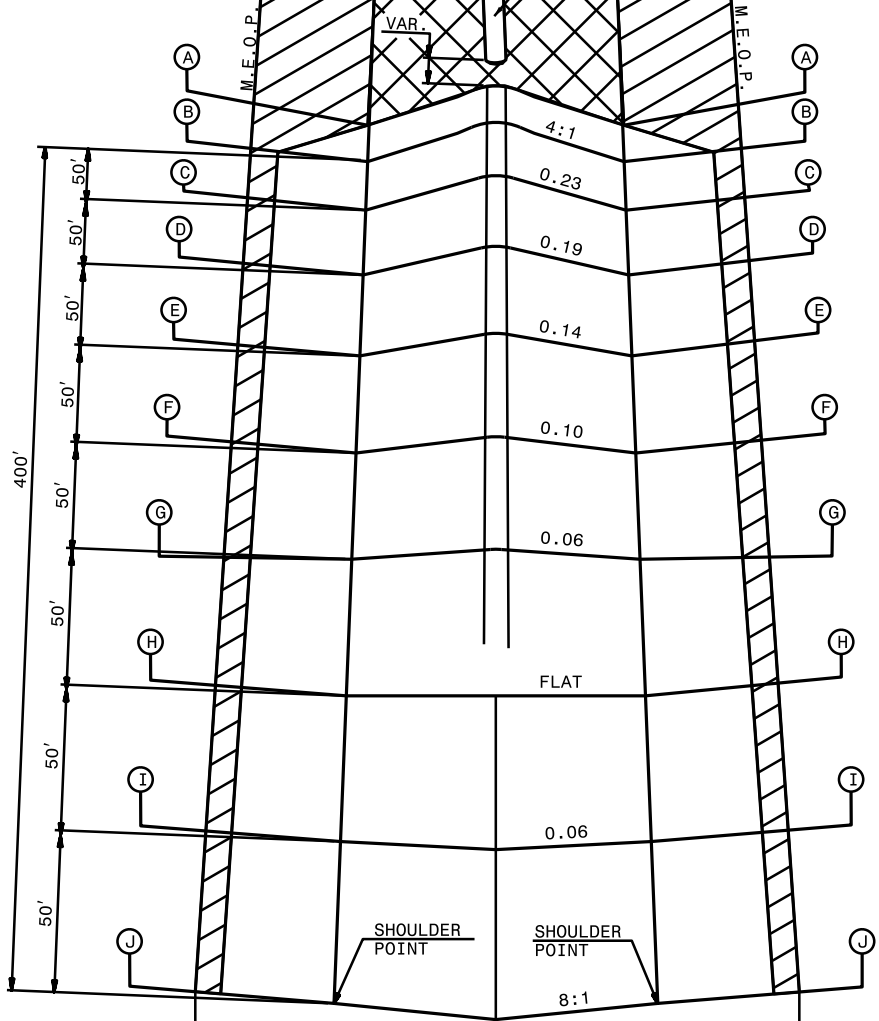
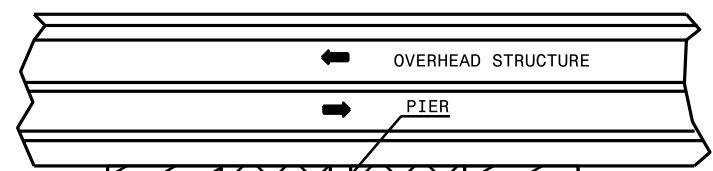

REFER TO PROJECT TYPICAL SECTIONS FOR MEDIAN WIDTH

PERSPECTIVE

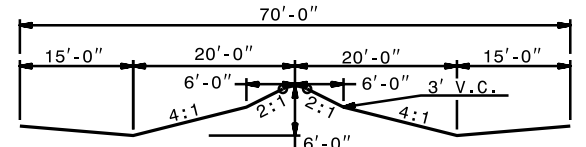

SECTION A-A & B-B

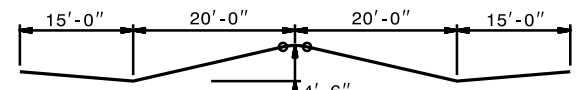

SECTION C-C

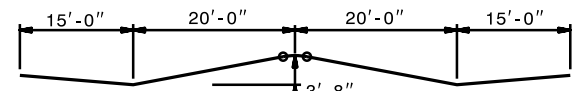

SECTION D-D

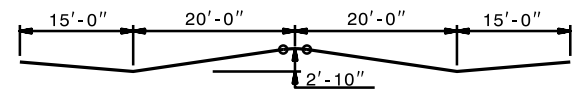

SECTION E-E

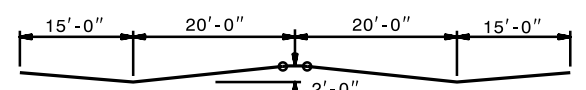

SECTION F-F

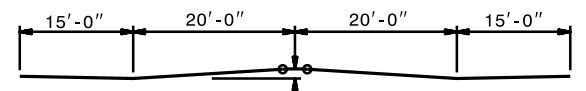

SECTION G-G

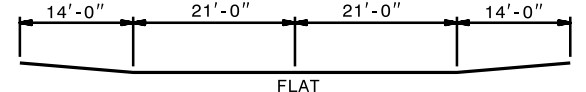

SECTION H-H

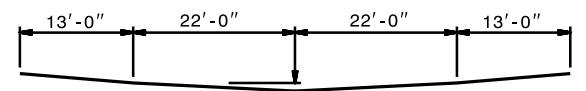

SECTION I-I

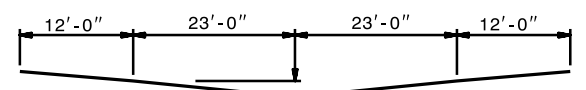

SECTION J-J

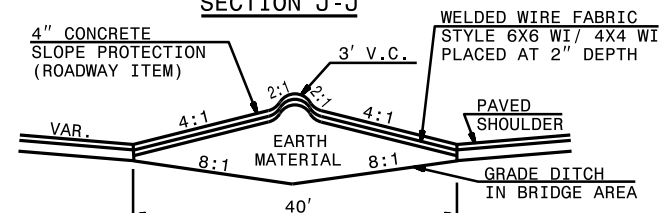

SECTION X-X

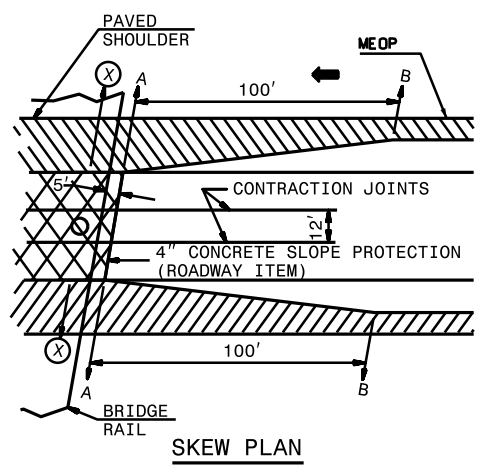

SKEW PLAN

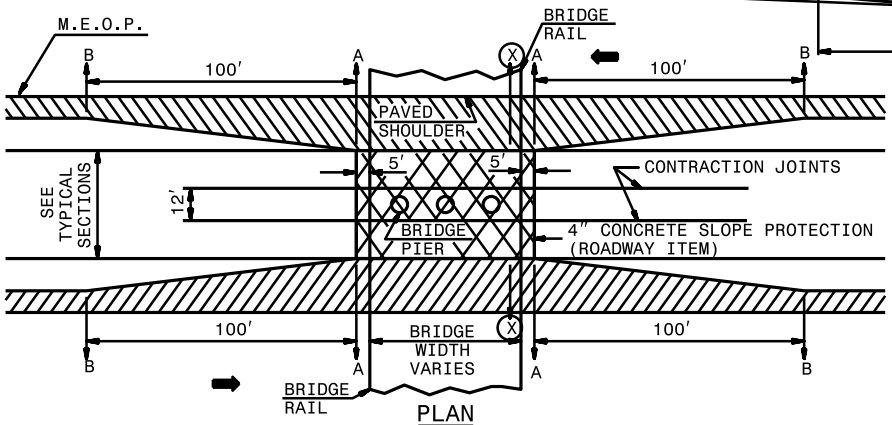

PLAN

GENERAL NOTES:

1. GRADING

- A. IN CUTS - EXCAVATE THE MEDIAN BETWEEN SECTIONS A-A AND J-J AS SHOWN IN PERSPECTIVE VIEW. EXCAVATE BETWEEN SECTIONS A-A AND A-A TO THE GRADED DITCH SHAPE SHOWN ON SECTION X-X. AFTER COMPLETION OF THE MEDIAN BRIDGE PIERS, BACKFILL THE AREA BETWEEN SECTIONS A-A AND A-A TO THE SHAPE OF THE 4" CONCRETE SLOPE PROTECTION SHOWN ON SECTION X-X.
- B. IN FILLS - CONSTRUCT THE MEDIAN BETWEEN SECTIONS A-A AND A-A TO THE GRADED DITCH SHAPE SHOWN ON SECTION X-X. AFTER COMPLETION OF THE MEDIAN BRIDGE PIERS, CONSTRUCT THE AREA BETWEEN SECTIONS A-A AND A-A TO THE SHAPE OF THE 4" CONCRETE SLOPE PROTECTION SHOWN ON SECTION X-X. THE MEDIAN EARTH BERMS BETWEEN SECTIONS J-J AND A-A, AS SHOWN IN PERSPECTIVE VIEW, MAY BE CONSTRUCTED PRIOR TO COMPLETION OF THE MEDIAN BRIDGE PIERS.

2. CONCRETE SLOPE PROTECTION

PLACE THE 4" CONCRETE SLOPE PROTECTION IN ACCORDANCE WITH THESE DETAILS. PROPERLY SHAPE AND FIRMLY COMPACT EARTH MATERIAL BEFORE PLACING SLOPE PROTECTION REINFORCING AND CONCRETE. FINISH THE CONCRETE SURFACE WITH A WOODEN FLOAT.

TRANSVERSE JOINTS: FORM A GROOVED JOINT 1" DEEP WITH $\frac{1}{8}$ " RADII AT APPROXIMATELY 10' INTERVALS. LOCATE A GROOVED JOINT OR A CONSTRUCTION JOINT SO AS TO INTERSECT THE EXPANSION JOINT MATERIAL PLACED AROUND EACH PIER. NO SEALING OF THESE JOINTS IS REQUIRED. WIRE MESH TO BE LAPPED 6" AT ALL CONSTRUCTION JOINTS. SPACE CONTRACTION JOINTS AT 25' INTERVALS.

1-24

ROADWAY STANDARD DRAWING FOR

EARTH BERM MEDIAN PIER PROTECTION

STATE OF

NORTH CAROLINA

DEPT. OF TRANSPORTATION

DIVISION OF HIGHWAYS

RALEIGH, N.C.

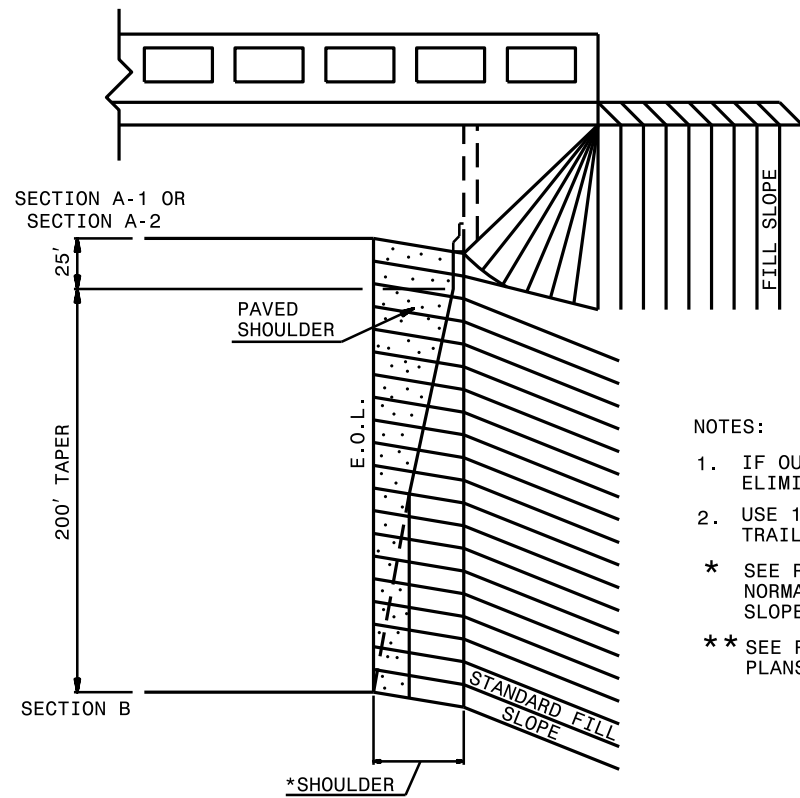

FOR FILL APPROACHES

NOTES:

1. IF OUTSIDE PIER IS USED (A-3), ELIMINATE 6' VERTICAL CURVE ON B-1.
2. USE 100'-300' TRANSITION ON THE TRAILING SIDE OF CUT SECTION.
- * SEE ROADWAY TYPICAL SECTIONS FOR NORMAL SHOULDER WIDTHS, SHOULDER SLOPES, AND DITCH WIDTHS.
- ** SEE ROADWAY PLANS AND/OR STRUCTURE PLANS FOR OFFSET.

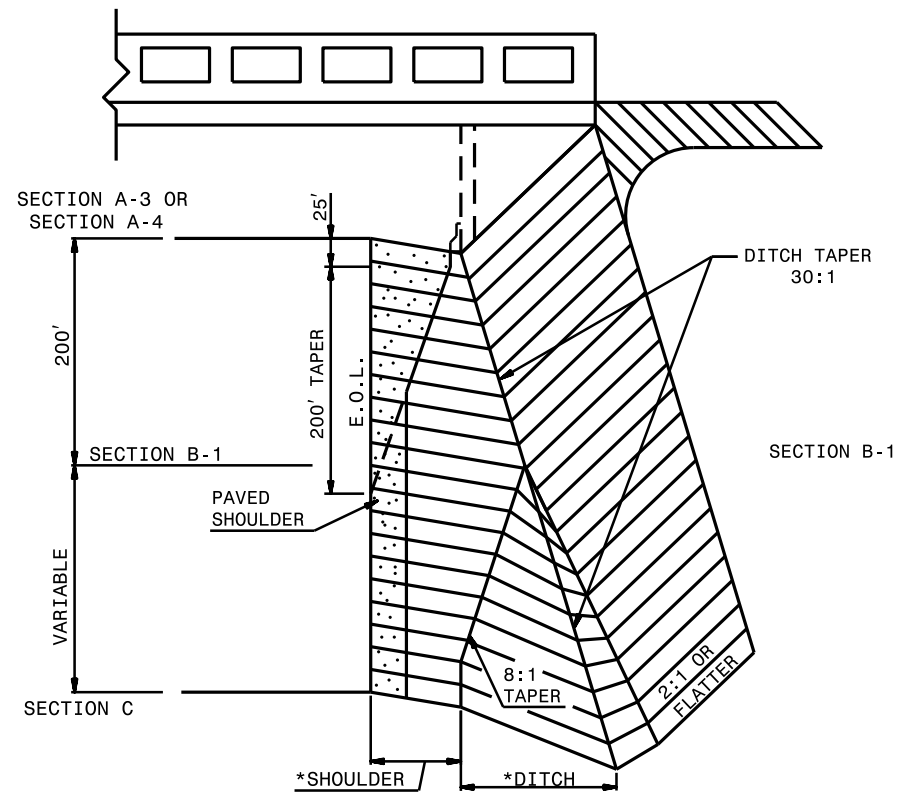

FOR CUT APPROACHES

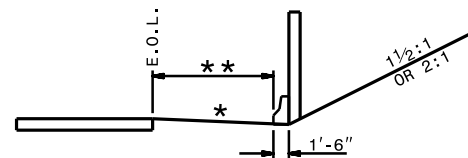

SECTION A-1

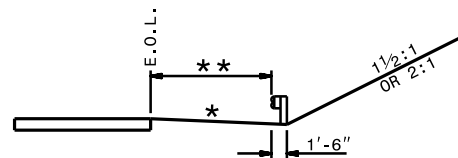

SECTION A-2

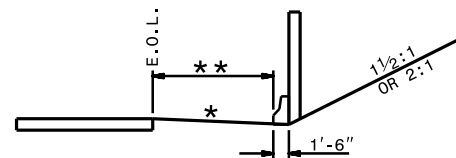

SECTION A-3

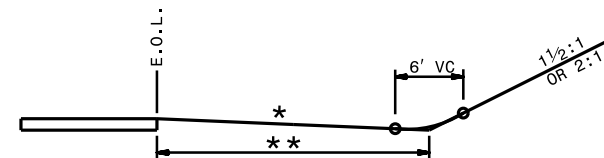

SECTION A-4

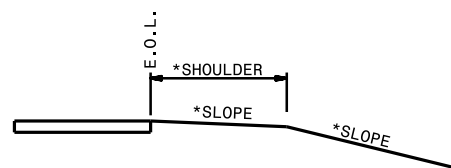

SECTION B

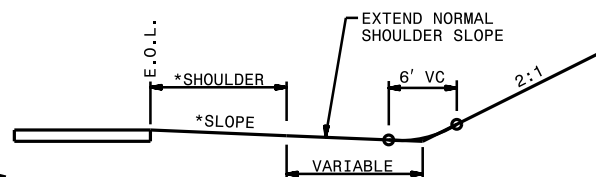

SECTION B-1

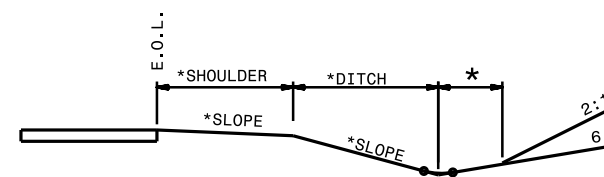

SECTION C

EMBANKMENT MONITORING SEQUENCE

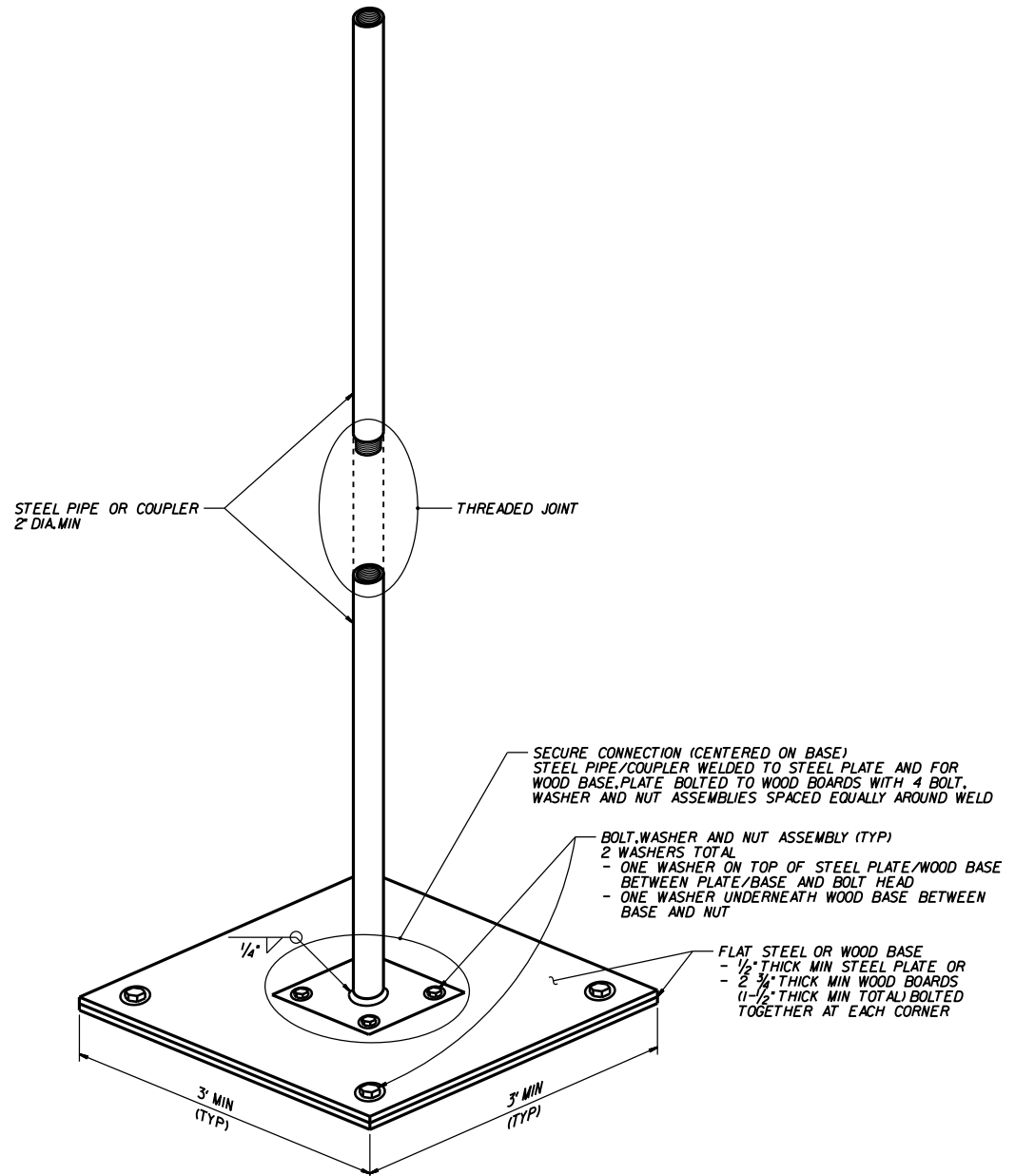
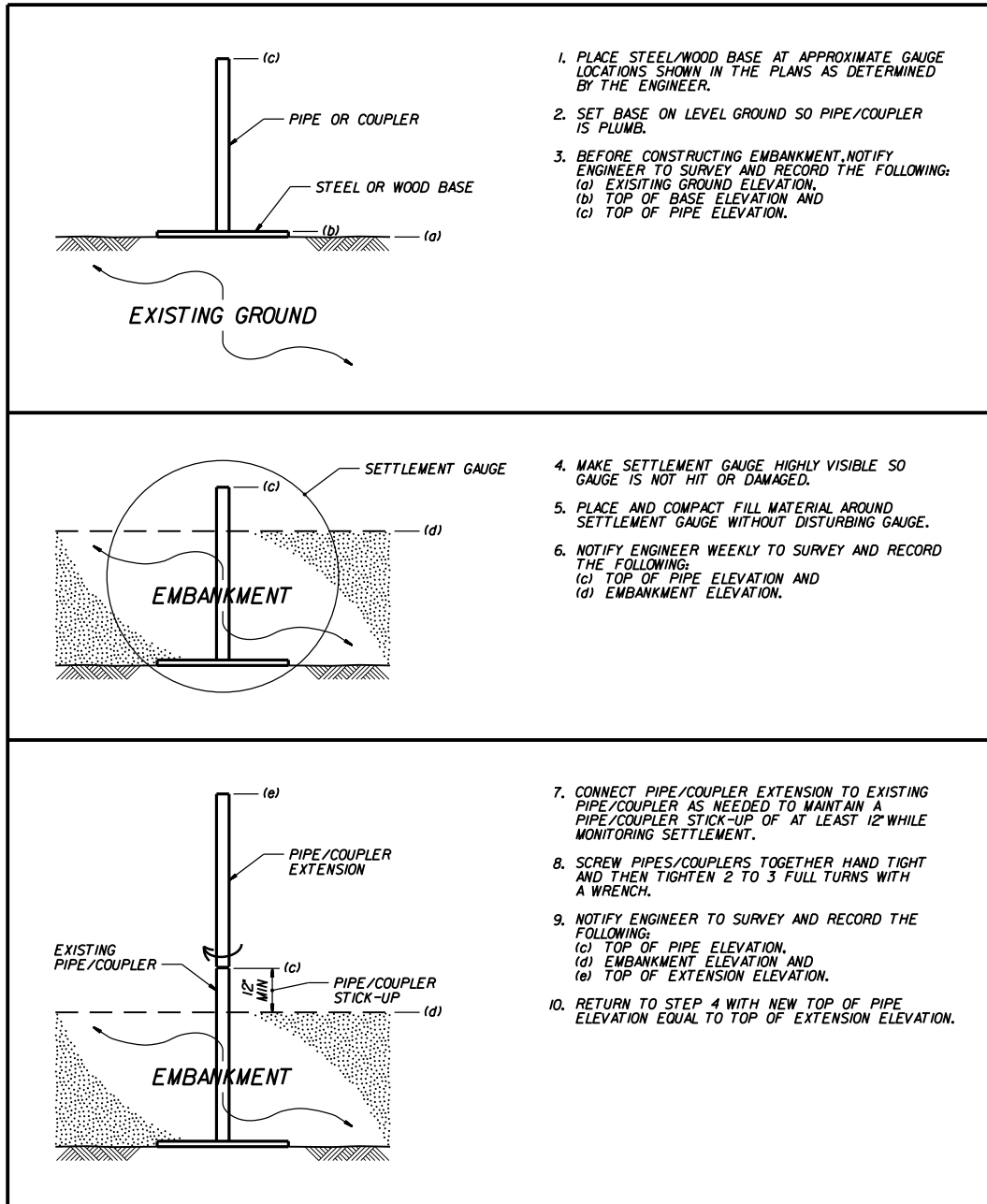

SETTLEMENT GAUGE

NOTES:

1. SEE ROADWAY SUMMARY SHEETS FOR APPROXIMATE SETTLEMENT GAUGE LOCATIONS.
2. FOR EMBANKMENT MONITORING, SEE SECTION 235 OF THE STANDARD SPECIFICATIONS.
3. WELD IN ACCORDANCE WITH THE AWS D11 STRUCTURAL WELDING CODE - STEEL.
4. INSTALL SETTLEMENT GAUGES AFTER CLEARING AND GRUBBING GAUGE LOCATIONS AND BEFORE CONSTRUCTING EMBANKMENTS WITH EMBANKMENT MONITORING.

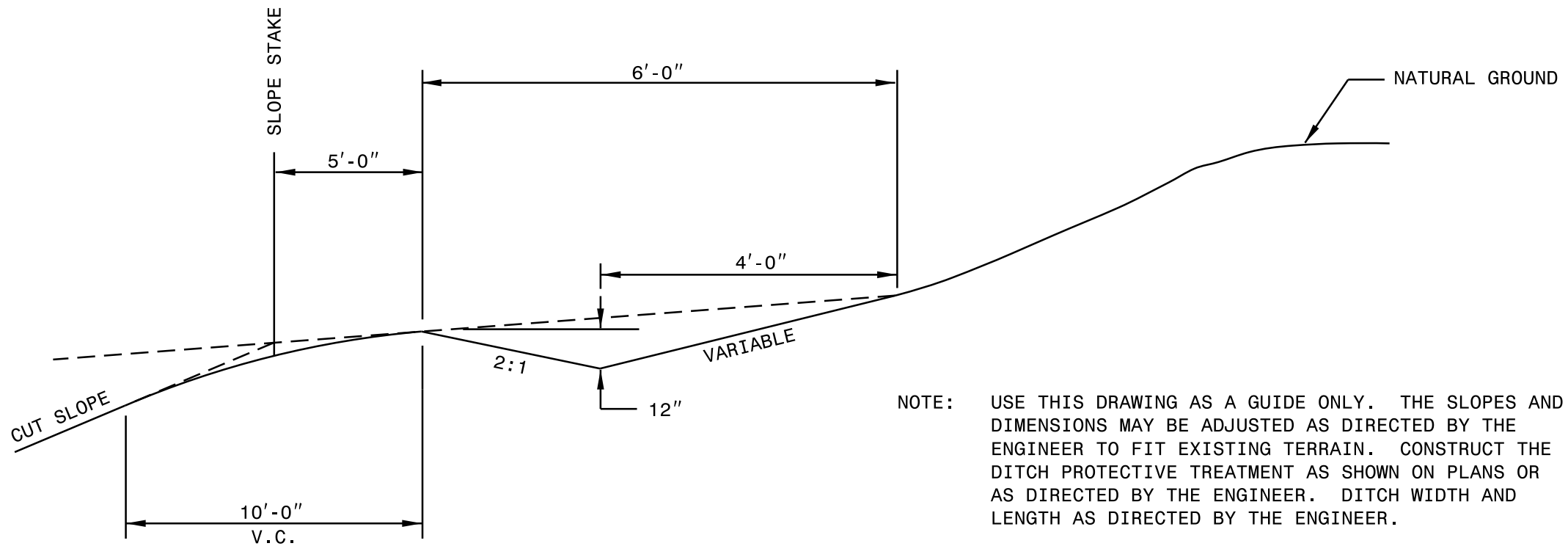

NOTE: USE THIS DRAWING AS A GUIDE ONLY. THE SLOPES AND DIMENSIONS MAY BE ADJUSTED AS DIRECTED BY THE ENGINEER TO FIT EXISTING TERRAIN. CONSTRUCT THE DITCH PROTECTIVE TREATMENT AS SHOWN ON PLANS OR AS DIRECTED BY THE ENGINEER. DITCH WIDTH AND LENGTH AS DIRECTED BY THE ENGINEER.

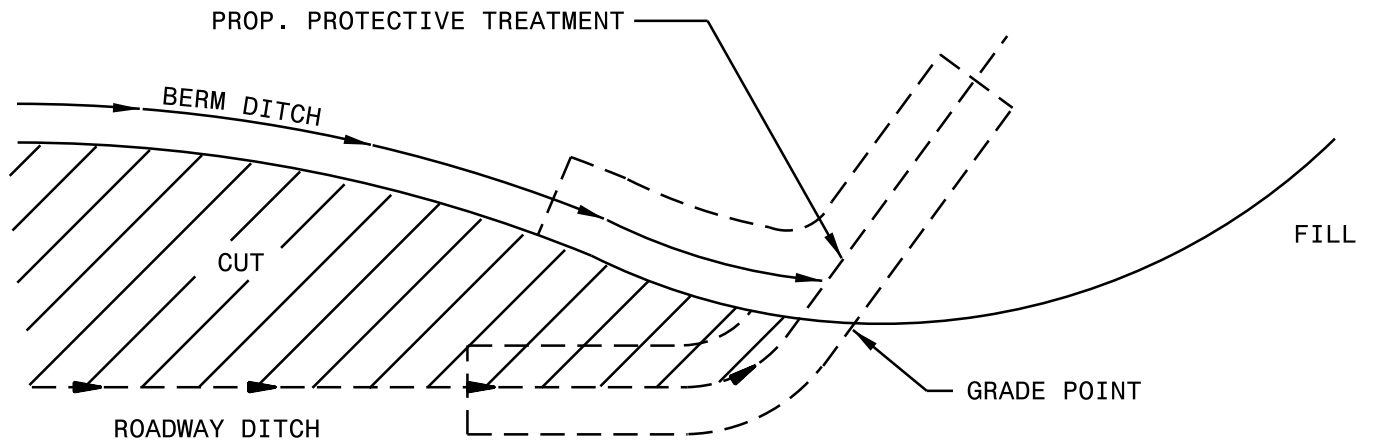

PLAN

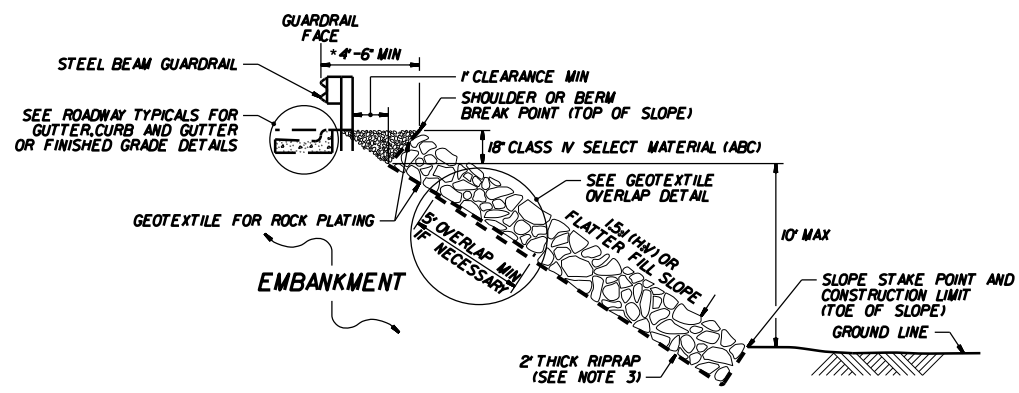

ROCK PLATING DETAIL NO. 1 - TYPICAL SECTION

* 3'-6\"/>

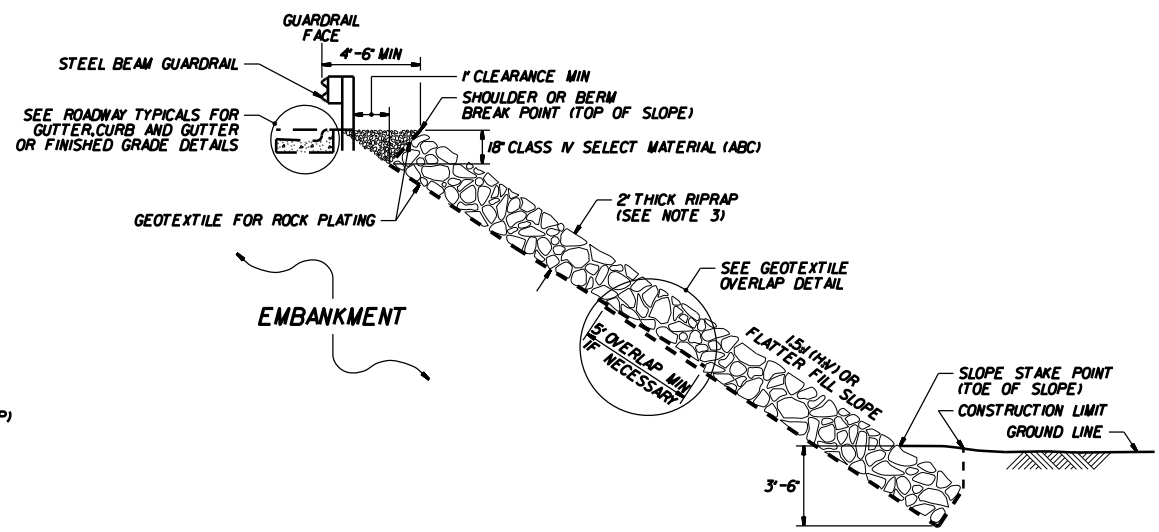

ROCK PLATING DETAIL NO. 2 - TYPICAL SECTION

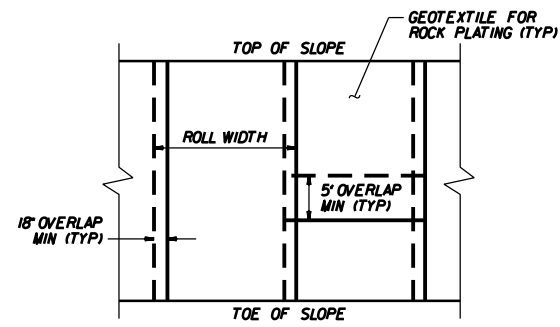

GEOTEXTILE OVERLAP DETAIL

(PLAN VIEW)

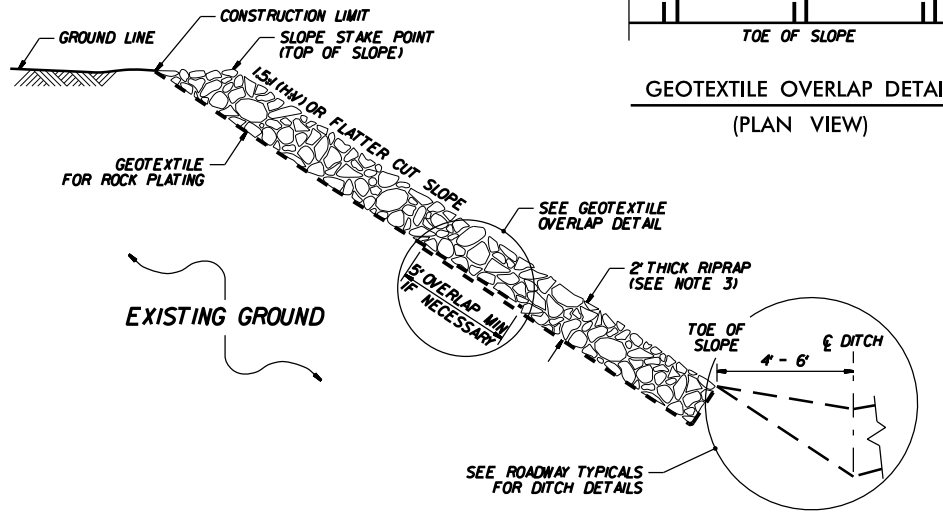

ROCK PLATING DETAIL NO. 3 - TYPICAL SECTION

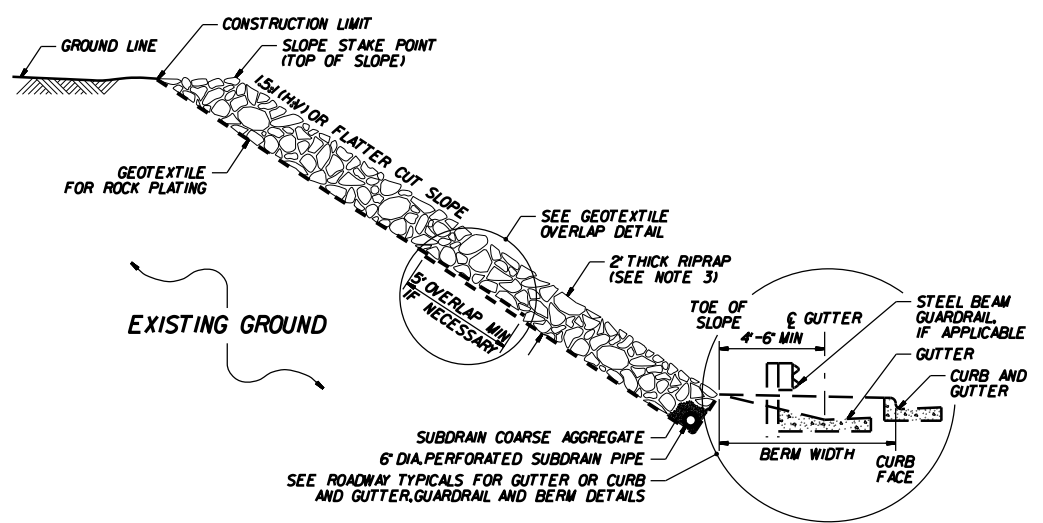

ROCK PLATING DETAIL NO. 4 - TYPICAL SECTION

- NOTES:**
1. SEE ROADWAY PLANS AND SUMMARY SHEETS FOR ROCK PLATING LOCATIONS.
 2. FOR ROCK PLATING, SEE SECTION 275 OF THE STANDARD SPECIFICATIONS.
 3. USE CLASS 1,2 OR B RIPRAP UNLESS REQUIRED OTHERWISE IN THE ROADWAY SUMMARY SHEETS.