



**AssetWise Asset  
Reliability Inspections**  
CONNECT Edition

# Ohio Bridge Inventory Coding Guide



**ORC 723.54, 5501.47, 5543.20**  
***Revised 2021-01***

# Ohio Bridge Inventory Guide

---

## TABLE OF CONTENTS

INTRODUCTION.....	11
INVENTORY RESPONSIBILITY.....	11
DEFINITIONS.....	12
AssetWise Bridge Inventory Coding Guide .....	16
STRUCTURE FILE NUMBER (SFN).....	16
Updating the Bridge Inventory Records.....	17
Creating an Asset in AWS.....	18
Updating Bridge Data (Edit Asset Values).....	18
Retiring a Bridge Record, SFN (Asset) .....	18
NOMENCLATURE.....	19
STRUCTURE INVENTORY CODING INSTRUCTIONS.....	22
National Bridge Inventory (NBI) Items.....	22
NBI #1 – State Code .....	22
NBI #2 – Highway Agency District.....	22
NBI #3 – County (Parish) Code .....	22
NBI #4 – Place Code (FIPS) .....	23
NBI #5 – Inventory Route.....	23
NBI # 5A – Record Type (On/Under).....	23
NBI # 5B – Route Signing Prefix (Highway System).....	25
NBI #5C – Designated Level of Service (Highway Designation) .....	26
NBI #5D – Route Number.....	26
NBI #5E – Directional Suffix .....	27
NBI #6 – Feature Intersected .....	27
NBI #7 – Facility Carried by Structure .....	27
NBI #8 – Structure File Number (SFN).....	27
NBI #9 – Location .....	27
NBI #10 – Inventory Route, Minimum Vertical Clearance.....	27
NBI # 11 – Mile-point .....	28
NBI # 12 – Base Highway Network.....	29
NBI # 13 – A - LRS Inventory Route, B - Subroute Number.....	29
NBI #14 and NBI #15 - Reserved .....	29

# Ohio Bridge Inventory Guide

---

NBI # 16 – Latitude.....	29
NBI # 17 – Longitude.....	31
NBI #18 - Reserved.....	33
NBI # 19 – Bypass, Detour Length.....	33
NBI #20 – Toll .....	35
NBI #21 – Maintenance Responsibility .....	35
NBI #22 – Owner .....	36
NBI #23, NBI #24 and NBI #25 - Reserved.....	37
NBI #26 – Functional Classification of Inventory Route.....	37
NBI #27 – Year Built .....	37
NBI #28 – Lanes On and Lanes Under .....	38
NBI #28A – Lanes On.....	38
NBI #28B – Lanes Under.....	38
NBI #29 – Average Daily Traffic (ADT).....	38
NBI #30 – Year of Average Daily Traffic .....	39
NBI #31 – Design Load .....	39
NBI #32 – Approach Roadway Width.....	39
NBI #33 – Bridge Median .....	40
NBI #34 – Skew.....	40
NBI #35 – Structure Flared.....	41
NBI #s 36A, B, C, & D – Traffic Safety Features.....	41
NBI #37 – Historical Significance Code.....	41
NBI #38 – Navigation Control.....	41
NBI #39 – Navigation Vertical Clearance .....	41
NBI #40 – Navigation Horizontal Clearance .....	42
NBI #41 – Structure Open, Posted, or Closed to Traffic.....	42
NBI #42A – Type of Service On .....	43
NBI #42B – Type of Service Under .....	43
NBI #43 –Structure Type - Main.....	43
NBI #44 – Structure Type - Approach .....	45
NBI #45 – Number of Spans in Main Unit .....	46
NBI #46 – Number of Approach Spans .....	46

# Ohio Bridge Inventory Guide

---

NBI #47 – Inventory Route, Total Horizontal Clearance .....	46
NBI #48 – Length of Maximum Span.....	48
NBI #49 – Structure Length.....	48
NBI #50A – Curb or Sidewalk Left Side – Width.....	50
NBI #50B – Curb or Sidewalk Right Side - Width .....	50
NBI #51 – Bridge Roadway Width, Curb-to-Curb.....	50
NBI #52 – Deck Width (Out/Out) .....	51
NBI #53 – Minimum Vertical Clearance over Bridge Roadway.....	53
NBI #54 – Minimum Vertical Underclearance .....	53
NBI #55 – Minimum Lateral Underclearance on Right .....	54
NBI #56 – Minimum Lateral Underclearance Left .....	55
NBI #57 - Reserved.....	57
NBI #58 through Item 62 – Indicate the Condition Ratings .....	57
NBI #63 – Method Used to Determine Operating Rating .....	57
NBI #64 – Operating Rating.....	58
NBI #65 – Method Used to Determine Inventory Rating.....	59
NBI #66 – Inventory Rating .....	60
NBI #s 67, 68, 69 – Refer to FHWA Coding Guide.....	61
NBI #70 – Bridge Posting.....	62
NBI #71 – Waterway Adequacy .....	64
NBI #72 – Approach Roadway Alignment.....	65
NBI #73 and NBI #74 - Reserved .....	66
NBI #75 – Type of Work .....	67
NBI #76 – Length of Structure Improvement.....	68
NBI #77 through NBI #89 .....	69
NBI #90 – Inspection Date.....	70
NBI #91, through #93 .....	70
NBI #94 – Bridge Improvement Cost .....	70
NBI #95 – Roadway Improvement Cost .....	70
NBI #96 – Total Project Cost .....	71
NBI #97 – Year of Improvement Cost Estimate .....	71
NBI #98 - Border Bridge .....	71

# Ohio Bridge Inventory Guide

---

NBI #99 – Border Bridge Structure Number .....	72
NBI #100 – STRAHNET Highway Designation.....	72
NBI #101 – Parallel Highway Designation.....	72
NBI #102 – Direction of Traffic.....	73
NBI #103 – Temporary Structure Designation .....	74
NBI #104 – Highway System of the Inventory Route.....	74
NBI #105 – Federal Lands Highways .....	75
NBI #106 – Year Reconstructed .....	75
NBI #107 – Deck Structure Type .....	76
NBI #108– Wearing Surface/Protection System.....	76
NBI #109 – Average Daily Truck Traffic Percentage.....	78
NBI #110 – Designated National Network .....	78
NBI #111 – Pier Protection (for Navigation) .....	78
NBI #112 – NBIS Bridge Length .....	79
NBI #113 – Scour Critical Bridge .....	82
NBI #114 – Future Average Daily Traffic.....	85
NBI #115 – Year of Future Average Daily Traffic.....	85
NBI #116 – Minimum Navigation Vertical Clearance, Vertical Lift Bridge.....	85
OHIO BRIDGE INVENTORY ITEMS.....	86
Ohio Item 5.01 – Priority System Code.....	87
Ohio Item 16.01 – Latitude .....	87
Ohio Item 17.01 – Longitude .....	88
Ohio Item 43C – Main Structure Description.....	88
Ohio Item 43C – Approach Structure Description .....	89
Ohio Item 58.01 – Wearing Surface.....	89
Ohio Item 59.01 – Protective Coating System (PCS).....	89
Ohio Item 61.01 - Scour .....	89
Ohio Item 67.01 – General Appraisal.....	89
Ohio Item 70.01 – Date Posted.....	89
Ohio Item 70.02 – Posted Sign Type .....	89
Ohio Item 70.03 – Posted Weights .....	89
Ohio Item 107.01 – Deck Structure Type.....	89

# Ohio Bridge Inventory Guide

---

Ohio Item 108A.01 – Wearing Surface Description .....	90
Ohio Item 109.01 – Average Daily Truck Traffic (ADTT) .....	90
Ohio Item 201 – Special Designation .....	90
Ohio Item 202 – Bridge Inventory Status.....	90
Ohio Item 203 – Bridge Name (Dedicated Name) .....	90
Ohio Item 204 – Ohio Designated MPO.....	91
Ohio Item 206 – Inventory Preferred Route .....	91
Ohio Item 205 – Route Number Extension .....	91
Ohio Item 206 – Inventory Preferred Route.....	91
Ohio Item 207 – Route Type under the Bridge .....	91
Ohio Item 208 – Route Type on the Bridge .....	92
Ohio Item 209 – Interstate Mile Marker.....	92
Ohio Item 213 – NLF ID Inventory Route .....	92
Ohio Item 218 – Major Bridge .....	92
Ohio Item 221 – Inspection Program Responsibility A, & B.....	93
Ohio Item 224 – Temporary Sub decking .....	94
Ohio Item 225 – Routine Maintenance Responsibility A & B .....	94
Ohio Item 226 – Seismic Susceptible .....	95
Ohio Item 227 – GASB (Governmental Accounting Standards Board) .....	95
Ohio Item 236 – Future Traffic Factor .....	95
Ohio Item 245 – Aperture Cards Fabrication .....	95
Ohio Item 246 – Aperture Cards Original .....	95
Ohio Item 247 – Aperture Cards Repair.....	95
Ohio Item 248 – Original Construction Project Number.....	96
Ohio Item 251 – Standard Drawing Number .....	96
Ohio Item 252 – Microfilm Reel Number.....	96
Ohio Item 253 – SFN Replacing This Retired Bridge .....	96
Ohio Item 255 – SFN That Was Replaced by This Bridge.....	96
Ohio Item 257 – Record Retiring Reason.....	96
Ohio Item 258 – Date Open to Traffic.....	96
Ohio Item 259 – Record Add Date .....	96
Ohio Item 260 – Record Retire Date.....	96

# Ohio Bridge Inventory Guide

---

Ohio Item 261 – Bridge Remarks .....	97
Ohio Item 263 – Date Built.....	97
Ohio Item 264 – Major Reconstruction Date.....	97
Ohio Item 265 – Electric Line Present.....	98
Ohio Item 266 – Gas Line Present.....	98
Ohio Item 269 – Sanitary Sewer Present .....	98
Ohio Item 301 – Horizontal Curve .....	98
Ohio Item 306 – NBIS Bridge Length.....	99
Ohio Item 335A – Minimum Horizontal Clearance - Inventory Route, Cardinal .....	100
Ohio Item 335B – Minimum Horizontal Clearance - Inventory Route Non-Cardinal .....	101
Ohio Item 336A – Minimum Vertical Clearance -Inventory Route Cardinal.....	101
Ohio Item 336B – Minimum Vertical Clearance -Inventory Route Non-Cardinal.....	101
Ohio Item 404 – Approach Slab Type .....	102
Ohio Item 405 – Approach Slab Length .....	102
Ohio Item 406 – Bridge Median Type .....	102
Ohio Item 407 – Bridge Railing Type.....	103
Ohio Item 408 – Composite Deck Code .....	104
Ohio Item 409 – Deck Drainage Type .....	105
Ohio Item 411 – Deck Concrete Type .....	105
Ohio Item 414A, B & C – Expansion Joint Type.....	106
Ohio Item 419 – Expansion Joint W/Trough Retrofit.....	106
Ohio Item 421 – Expansion Joint W/Trough .....	106
Ohio Item 422 – Wearing Surface Date .....	106
Ohio Item 423 – Wearing Surface Thickness .....	107
Ohio Item 424 – Deck Area .....	107
Ohio Item 427 – Left Sidewalk/Curb Material .....	107
Ohio Item 428 – Left Sidewalk/Curb Type .....	107
Ohio Item 429 – Right Sidewalk/Curb Material .....	107
Ohio Item 430 – Right Sidewalk/Curb Type .....	108
Ohio Item 431 – Fence .....	108
Ohio Item 434 – Noise Barrier Walls.....	108
Ohio Item 453 – Bearing Device 1, Type.....	108

# Ohio Bridge Inventory Guide

---

Ohio Item 455 – Bearing Device 2, Type.....	109
Ohio Item 459 – Inspection Access System .....	109
Ohio Item 465 – Framing Type.....	109
Ohio Item 466 – Haunched Girder .....	109
Ohio Item 467 – Haunched Girder Depth .....	110
Ohio Item 468 – Hinges/Pins/Hangers Type.....	110
Ohio Item 474 – Main Structure System.....	110
Ohio Item 475 – Main Member Type.....	110
Ohio Item 478 – Post Tensioned Main Member Code .....	111
Ohio Item 482 – Protective Coating System (PCS) Type .....	111
Ohio Item 483 – Protective Coating System (PCS) Date .....	112
Ohio Item 487 – Structural Member Steel Type .....	112
Ohio Item 499 – Structural Steel Paint .....	112
Ohio Item 526 – Abutment Forward Type .....	112
Ohio Item 527 – Abutment Forward - Material Type .....	113
Ohio Item 528 – Abutment Forward - Foundation Type .....	113
Ohio Item 531 – Abutment Rear Type .....	114
Ohio Item 532 – Abutment Rear - Material Type .....	114
Ohio Item 533 – Abutment Rear - Foundation Type .....	115
Ohio Item 534 – Pier 1 (Predominate) Type .....	115
Ohio Item 535 – Pier 1 (Predominate) Material .....	116
Ohio Item 536 – Pier 1 Type - Foundation Type .....	116
Ohio Item 537 – Pier 2 Type.....	116
Ohio Item 538 – Pier 2 Material.....	117
Ohio Item 539 – Pier 2 Type - Foundation Type .....	117
Ohio Item 547 – Slope Protection Type .....	118
Ohio Item 575 – Culvert Type .....	118
Ohio Item 578 – Culvert Pipe Length (Inlet – Outlet) .....	119
Ohio Item 580 – Fill Depth over Culvert .....	119
Ohio Item 587 – Rise .....	119
Ohio Item 588 – Shape.....	119
Ohio Item 651 – Scenic River .....	120



# Ohio Bridge Inventory Guide

---

Ohio Item 655 – Channel Protection Type.....	120
Ohio Item 663 – Stream Velocity .....	120
Ohio Item 672 – pH value .....	120
Ohio Item 704 – Load Rating Date .....	120
Ohio Item 705 – Load Rater First Name.....	120
Ohio Item 706 – Load Rater Last Name .....	121
Ohio Item 707 – Load Rater Ohio PE Number .....	121
Ohio Item 708 – Load Rating Software .....	121
Ohio Item 709 – Rating Source .....	121
Ohio Item 711 – Live Load Response .....	121
Ohio Item 717 – 2F1 Operating Rating Factor (GVW 15 T).....	121
Ohio Item 720 – 3F1 Operating Rating Factor (GVW 23 T).....	122
Ohio Item 723.01 – 4F1 Operating Rating Factor (GVW 27 T).....	122
Ohio Item 723.02 – SU4 Operating Rating Factor (GVW 27 T) .....	122
Ohio Item 726.01 – 5C1 Operating Rating Factor (GVW 40 T) .....	122
Ohio Item 726.02 – SU5 Operating Rating Factor (GVW 31 T) .....	122
Ohio Item 732.01 – SU6 Operating Rating Factor (GVW 34.75 T) .....	122
Ohio Item 732.02 – SU7 Operating Rating Factor (GVW 38.75 T) .....	122
Ohio Item 734 – Ohio Percent Legal .....	122
Ohio Item 735 – EV2 Operating Rating Factor (GVW 28.75 T) .....	123
Ohio Item 738 – EV3 Operating Rating Factor (GVW 43 T) .....	123
Ohio Item 825 – Historical Bridge Name .....	123
Ohio Item 826 – NR Recommendation .....	123
Ohio Item 831 – Historical Builder .....	123
Under Records .....	130
APPENDIX A – Ohio Counties .....	131
APPENDIX B – NBI #4 Place Codes (FIPS) .....	134
APPENDIX C – Ohio Structure Type Coding.....	175
APPENDIX D – Substructure - Abutments & Piers.....	184
APPENDIX E – Ohio Item 248 Original Construction Project Number .....	188
APPENDIX F – NBI #19 Bypass (Detour) Length .....	190
APPENDIX G – ODOT Standardized Coding for Route Number Suffix.....	191

# Ohio Bridge Inventory Guide

---

APPENDIX H – Coding of Load Rating ..... 192

# Ohio Bridge Inventory Guide

---

## INTRODUCTION

This ODOT Bridge Inventory Coding Guide has been revised to make it compliant with the FHWA Recording and Coding Guide for the Structure Inventory and Appraisal of the Nation's Bridges (Report No. FHWA-PD-96-001), published in December 1995 and all subsequent revisions with the exception that the whole bridge inventory is in English Units. This Bridge Coding Guide is to be used to do bridge inventory coding in ODOT AssetWise System (AWS.)

Excerpts and/or items from the previous versions of ODOT Bridge Inventory Coding Guide were used in preparing this Coding Guide.

Federal legislations and publications by the U.S. Department of Transportation, Federal Highway Administration (FHWA) require that bridge data herein specified, be collected and maintained for all bridges on the Public Highway and Street System in Ohio. It will be possible to accomplish this task only through the complete cooperation of all government and local agencies involved. Most of the identification and structural data required is available from existing bridge plans or inventories of the various agencies, as established under Section(s) 723. 54, 5501.47, 5543.20 of the Ohio Revised Code (ORC). Some items required may compel an agency to make field measurements to obtain accurate and up-to-date data.

Each agency (ODOT District, County, Municipality, Turnpike Commission, etc.) shall be responsible for the validity and accuracy of data for its own bridges.

All bridges and culverts carrying or going over public streets and highways shall be inventoried. It is necessary that all bridges be inventoried and coded with respect to a route known as the "Inventory Route" which is defined in more detail in the Bridge Inventory Coding Guide.

## INVENTORY RESPONSIBILITY

*In order to eliminate duplication of records the following rule shall apply.*

*For the purposes of this inventory each agency, State, County and Municipality shall inventory **only the structures for which it has inspection responsibility under Ohio law, or by any special written agreement legally transferring inspection responsibility.** Agencies charged by law with only maintenance of a structure must **not** place that bridge record on file. Exceptions to this rule are private and industrial structures over or under an agency route and for which the inspection responsibility has been assigned by law or mutual agreement to the private agency. In this case, the agency whose route goes over or under shall inventory the structure.*

*Every structure shall be tied to an inventory route of the roadway inventory system. Structures separating grades of two (2) or more intersected routes shall be inventoried on the route carried by the bridge, i.e., code using the route on the structure as the "Inventory Route." When a structure is not carrying a highway route, then the primary route under the bridge shall be used as Inventory Route.*

# Ohio Bridge Inventory Guide

---

*For bridges with joint Inspection Responsibility, a public agency would be responsible to do the bridge inventory as per hierarchy (State, Turnpike, County, and Municipality) unless a special agreement is in place.*

*In special cases a public agency may be required to inventory a bridge inspected or maintained by a border state (Indiana, Kentucky, Michigan, Pennsylvania, or West Virginia) for cross reference or holding bridge clearance information.*

## DEFINITIONS

**Bridge** - A structure including intermediate supports erected over a depression or an obstruction such as water, highway or railway and having a truck or passageway for carrying traffic or other moving loads and having an opening of 10 feet or greater (clear span, distance between interior faces of extreme ends), or 10 feet or greater diameter, on, above, or below a highway measured along the centerline of the roadway. Multiple openings shall be grouped as one bridge when the distance between extreme ends of the adjacent openings is 10 feet or more with the clear distance between openings less than half of the clear span or diameter of the smallest opening in the group.

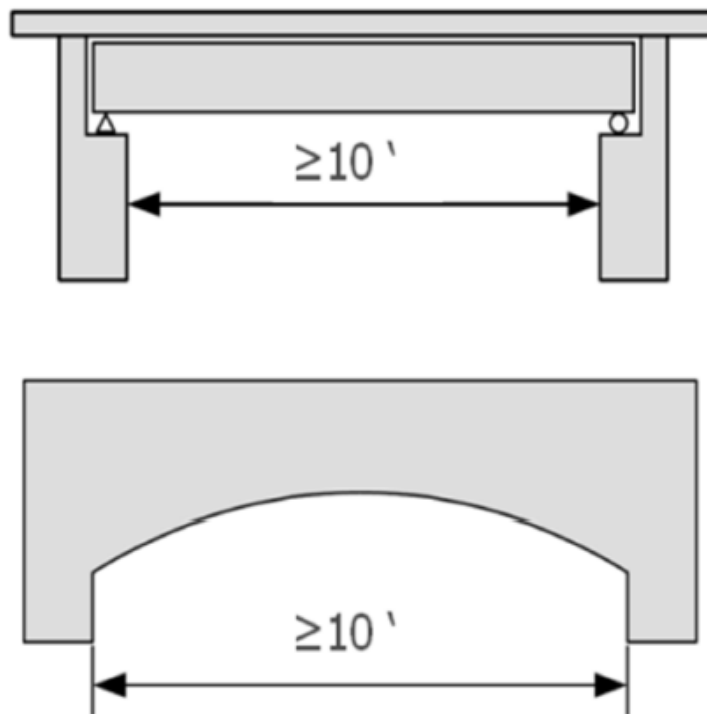

**Bridge Clear Span**

**Border Bridge (Border State Bridge):** A border bridge is a highway bridge which spans over the border with a neighboring state.

# Ohio Bridge Inventory Guide

---

Current directions of the FHWA require to maintain inventory and appraisal data of border bridges, irrespective of which agency of the neighboring state is inspecting and maintaining it. Refer to FHWA memo HIBS-30 dated February 9, 2018, which states, "States must communicate with the neighboring States to ensure that the data are consistent for both bridge records. This will require obtaining the inventory and appraisal data and annual changes in data from the respective neighboring state agency and copying into AWS.

**Culvert Bridge-** A Culvert is a structure designed hydraulically to take advantage of submergence to increase hydraulic capacity. Culverts, as distinguished from bridges, are usually covered with embankment and are composed of structural material around the entire perimeter, although some are supported on spread footings with the streambed serving as the bottom of the culvert. Culverts may qualify to be considered "bridge" length.

A structure with an opening of 10 feet or more measured along the centerline of the roadway, which conveys water or forms a passageway through an embankment and is designed to support superimposed loads of earth or other fill material plus a live load. Multiple cell culverts under a fill with a distance of 10 feet or more between extreme ends of the openings, measured along the center line of the roadway, including multiple pipes where the clear distance between openings is less than half of the diameter of the smallest opening, will be regarded as a culvert-bridge.

For guidance on structures less than 10 feet clear span, measured along the centerline (regardless of fill depth), entities should refer to the Ohio Department of Transportation, Office of Hydraulic Engineering, Culvert Management Manual.

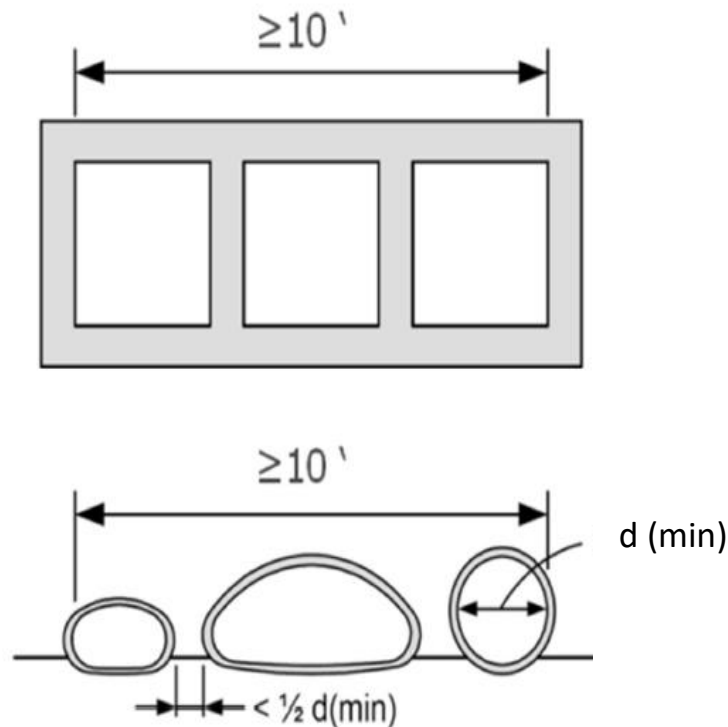

# Ohio Bridge Inventory Guide

---

## Bridge – Culvert Clear Span

**Major Bridge** – A Major Bridge, per funding source policy no. 16-003(P) is on the State Highway System and meets one or more of the following criteria (note that a consulting firm requesting prequalification in “major bridge” inspection shall refer to the latest version of the ODOT Consultant Prequalification Requirements and Procedures Manual as the definitions will defer based upon maximum span length for specific structure types):

- More than 1,000 feet in length
- Single bridge with a deck area of 81,000 square feet (9,000 square yards) or greater
- Twin bridges with a deck area of 135,000 square feet (15,000 square yards) or greater
- Spans the Ohio River
- Moveable bridge
- Continuous/cantilever truss bridge
- Suspension bridge

Bridges that do not meet any of the above definitions are not considered Major bridges.

**NBI Performance Measure:** - Beginning with calendar year 2018, changes in the federal law require to track performance of bridges as Good, Fair and Poor based on the condition summaries of the Deck, Super & Substructure or Culvert. Refer to Federal Register, Rule §490.401 through §490.413.

When the lowest rating of any of the 3 NBI items for a bridge (NBI #58-Deck, #59-Superstructure, #60-Substructure) is 7, 8, or 9, the bridge is classified as **Good**. When the rating for a culvert (NBI #62-Culverts) is 7, 8 or 9, the culvert will be classified as **Good**.

When the lowest rating of any of the 3 NBI items for a bridge (#58-Deck, #59-Superstructure, #60-Substructure) is 5 or 6, the bridge is classified as **Fair**. When the rating of NBI item for a culvert (#62-Culverts) is 5 or 6, the culvert will be classified as **Fair**.

When the lowest rating of any of the 3 NBI items for a bridge (#58-Deck, #59-Superstructure, #60-Substructure) is 4, 3, 2, 1 or 0, the bridge is classified as **Poor**. When the rating of NBI item for a culvert (#62-Culverts) is 4, 3, 2, 1 or 0, the culvert will be classified as **Poor**.

Currently, NBI Performance Measure is not being calculated within AssetWise.

**Non-Vehicular, Non-Railroad Bridges** – Pedestrian, closed bridges, etc. over public vehicular roadways shall be inventoried and inspected to ensure such structures do not pose an unacceptable safety risk to the public and vehicles under the bridge as per ODOT Bridge Inspection Manual. Any problems requiring immediate attention should be relayed to the Control Authority of the bridge by the responsible person of the inspecting entity.

# Ohio Bridge Inventory Guide

---

**Railroad Bridges** – Open or closed RR bridges over public vehicular roadways shall be inspected to ensure such structures do not pose an unacceptable safety risk to the public and vehicles under the bridge. Federal Regulation, 49 CFR part 237 (FRA), requires track owners to inspect each bridge each calendar year, therefore, entities responsible for the safe passage of public traffic underneath the railroad structure only need to focus on portions of the structure which would directly affect the right-of-way. Any problems requiring immediate attention should be relayed to the Control Authority of the bridge from the Control Authority of the overlapping right-of-way. Additionally, ORC 40907.44 requires track owners to send PUCO (Public Utilities Commission of Ohio) the annual inspection reports. If at any time a bridge is found to be dangerous or unfit for transportation of passengers, freight, or railroad crews, the railroad shall immediately report the condition of the bridge to the PUCO. When the bridge passes over a public highway, such report shall also be given to the public authority having jurisdiction over such highway.

**Status:** - Prior to year 2017, FHWA assigned Status of Structurally Deficient (SD) and Functionally Obsolete (FO) to bridges. These definitions are included here for historical purpose only.

## **Structurally Deficient -**

1. A condition rating of 4 or less for
  - Item 58 - Deck; or
  - Item 59 - Superstructures; or
  - Item 60 - Substructures; or
  - Item 62 - Culvert and Retaining Walls. or
2. An appraisal rating of 2 or less for
  - Item 67 - Structural Condition; or
  - Item 71 - Waterway Adequacy.

## **Functionally Obsolete -**

1. An appraisal rating of 3 or less for
  - Item 68 - Deck Geometry; or
  - Item 69 – Under-clearances; or
  - Item 72 - Approach Roadway Alignment. or
2. An appraisal rating of 3 for
  - Item 67 - Structural Condition; or
  - Item 71 - Waterway Adequacy.

**Any bridge classified** as structurally deficient is excluded from the functionally obsolete category.

- [1.](#) Item 62 applies only if the last digit of Item 43 is coded 19.
- [2.](#) Item 71 applies only if the last digit of Item 42 is coded 0, 5, 6, 7, 8 or 9.
- [3.](#) Item 69 applies only if the last digit of Item 42 is coded 0, 1, 2, 4, 6, 7 or 8.

# Ohio Bridge Inventory Guide

---

## AssetWise Bridge Inventory Coding Guide

The AssetWise Ohio Bridge Coding Guide (OBCG) is intended for use by State, County and Municipal highway officials and private consultants who will be authorized or tasked to perform the bridge inventory in the AWS.

The OBCG is maintained by the Bridge Inventory Section of the Office of Structural Engineering. Periodic updates to it, when deemed necessary, shall be published on the Office of Structural Engineering website in pdf format for download.

Inquiries concerning the material contained in this guide should be directed by phone and in writing to:

Ohio Department of Transportation  
Office of Structure Engineering  
1980 West Broad Street  
Mail Stop 5180  
Columbus, OH 43223  
Attn: Bridge Inventory Section

## STRUCTURE FILE NUMBER (SFN)

This is the identification number for the data file of a structure. It is seven (7) digit numeric, which is assigned by the AWS Administrator in the ODOT CO. **The Structure File Number is a permanent number assigned to the structure when the bridge is first conceived and remains so until the entire structure is demolished or removed from the system.** The first two (2) digits are the county number of the Ohio County (See Appendix "A") in which the structure is located. The last five (5) digits make up the specific number for that structure.

The specific structure number (digits three thru seven) will be assigned by AWS Administrator. If a structure is transferred from one (1) jurisdiction to another, such as County to State or vice versa, **it will no longer be given a new Structure File Number.** Instead you will change the responsibility code to match the new owner.

When inventorying a bridge **any structure(s) with a closed median is to be recorded as one bridge.** A closed median is where:

- 1) The area between the two roadways on the structure is bridged over and is capable of supporting traffic, or
- 2) The longitudinal deck opening at back-to-back median barriers is a maximum of 3 inches (75 mm) wide.

Separate superstructures with an open median (not meeting the closed median criteria above) sharing a common substructure unit or units are to be recorded as separate bridges. A structure carrying a ramp that merges into another structure has at least one (1) distinct abutment. And is equal to or greater than 10 feet (3.1 m) in length, is to be recorded as a separate bridge. The separating point between bridges



# Ohio Bridge Inventory Guide

---

should be the closest deck joint or other logical and reasonable location as determined by the bridge owner.

A structure that divides into two (2) (or more) separate structures is to be recorded as two (2) (or more) bridges. The separating point between bridges should be the closest deck joint or other logical and reasonable location as determined by the bridge owner.

The SFN of a bridge should usually not change when work is performed, or the portions of a structure are reconstructed except in unusual circumstances. A SFN is retained to maintain the history of the structure. Existing SFN of a bridge should be retired and a new SFN shall be assigned when a completely new Structure is built to replace the old Structure.

In case it is deemed necessary to retire the existing SFN and assign a new SFN to the bridge, the SFN retired shall be coded in the new SFN record in the System.

Some typical situations are listed below:

<b>Example</b>	<b>Scope</b>	<b>Need New SFN?</b>
1	Deck replacement	No
2	Superstructure replaced with same type	No
3	Widening	No
4	Replacing superstructure and modifying piers and abutments	No
5	Replacing complete bridge including foundations	Yes
6	New Superstructure of different type	Yes
7	Replacing Wearing Surface	No
8	Replacing Super and Substructure except piles	Yes
9	Repairing, Replacing or removing joints, bearings, railings, parapets, sidewalks, etc.	No

For other complex or unique situations not covered here, the bridge owner should contact the Office of Structural Engineering, Inventory Section.

## Updating the Bridge Inventory Records

Updating bridge records in AWS consists of adding a bridge, retiring a bridge from the database, or updating data of an existing bridge record. This includes inventory as well as inspection data of a bridge.

The agency (ODOT District, County, Municipality, Turnpike Commission, etc.) responsible for the inventory of a bridge shall also be responsible for maintaining the integrity of inventory data of the bridge. Each agency shall maintain its portion of the database on a day-to-day basis.

A complete review and update of the bridge records shall be accomplished at least once a year.

# Ohio Bridge Inventory Guide

---

F.H.W.A. requires prompt updating of data due to replacement, rehabilitation, load posting, inspection, etc. The maximum limit is 90 days for ODOT, and 180 days for Non-ODOT agencies.

## Creating an Asset in AWS

The creation or addition of a bridge asset in the AWS is the first step in establishing existence of the bridge in the system. This is a one-time entry and must be done before any updating (changes, inspection entries, etc.) can be performed. When a new SFN is created to a new bridge, it is in “Proposed” state and acts as a placeholder in the system. Once a bridge or a section of bridge is built, it shall be inventoried and made “Active” in AWS within 90 days of Date Open to Traffic.

The bridge must have corresponding NBI and Ohio inventory items coded in AWS before changing its status to “Active” in AWS. Duplicate bridge records, i.e., Structure File Numbers, shall not be allowed in the system.

## Updating Bridge Data (Edit Asset Values)

You can update data or edit asset values by choosing the **Edit Asset Values** button on the Asset Details page of AWS. Locate the item you wish to update and chose an entry from the appropriate dropdown menu or type in the data. Once you have clicked out of the item, the changes get saved automatically.

## Retiring a Bridge Record, SFN (Asset)

A bridge record, i.e. Structure File Number, may be retired from the System by changing the status of the bridge to Retired. Currently, only ODOT Central Office, Bridge Inventory Group can retire a SFN from the system for security reasons.

Choose **Manage Inventory under Administration**; find the SFN to be retired in the Asset Tree; and change the **Asset Status** to **Retired**. Select a Retire Reason in Ohio Item 257 - Record Retire Reason, before saving the change

<b>Code</b>	<b>Description</b>
1	Replaced
3	Abandoned (not on a public route)
4	Collapsed (not to be replaced)
5	Closed (not to be replaced)
7	Collapsed and replaced
0	Other

Table 1 - Retire Option

When a SFN is retired from the System, its records do not get deleted but get frozen. Retired bridges are stored as archived assets. No further additions/deletions/changes can be made to retired bridge records. A retired SFN cannot be reassigned to any other bridge.

# Ohio Bridge Inventory Guide

If the bridge gets accidentally retired, please contact the Office of Structural Engineering to make it active again.

## NOMENCLATURE

Bridges shall be labeled looking in cardinal direction or up station towards the increasing county log point. Typically up station direction is from the smallest to largest mile-marker or Straight Line Mileage (SLM).

1. Looking North on a North–South route
  - a. Rear abutment, or Abutment 1, is the South abutment, or at smaller SLM
  - b. Beams/Girders/Fascias/Truss lines are counted from the left to the right looking up station. In other words, the left fascia beam will be beam number 1.

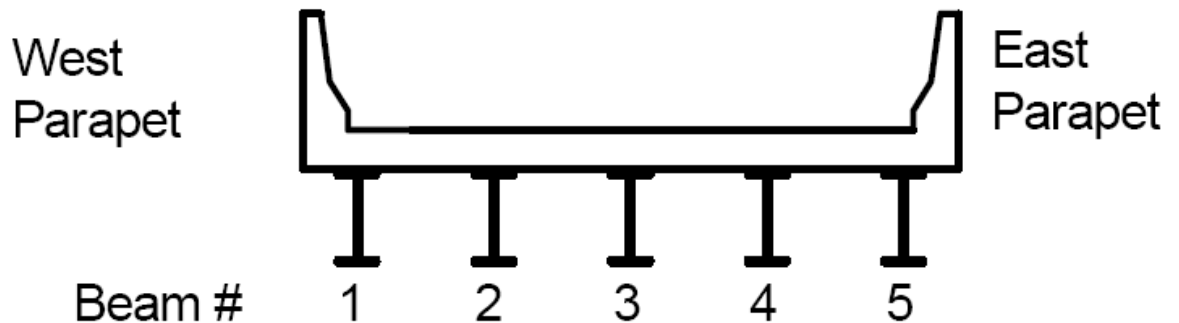

2. Looking East on an East-West route
  - a. Rear abutment, or Abutment 1, is the West abutment, or smaller SLM
  - b. Beams/Girders/Fascias/Truss lines are increasing from the left to the right looking up station. In other words, the left fascia beam will be beam number 1.
3. Pier number 1 will be the first pier looking up station from the rear abutment.

Left and Right (parallel) structures will follow the naming convention dictated by the increasing SLM.

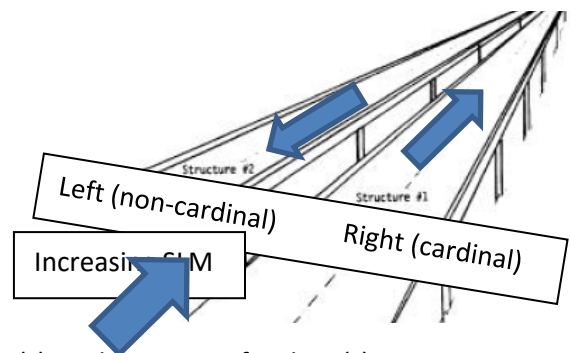

4. Lanes should be labeled driving slow, middle lane(s), and passing or fast lane(s).

# Ohio Bridge Inventory Guide

5. Span numbering increases with the SLM. In other words, Span 1 will always be supported by the rear abutment.

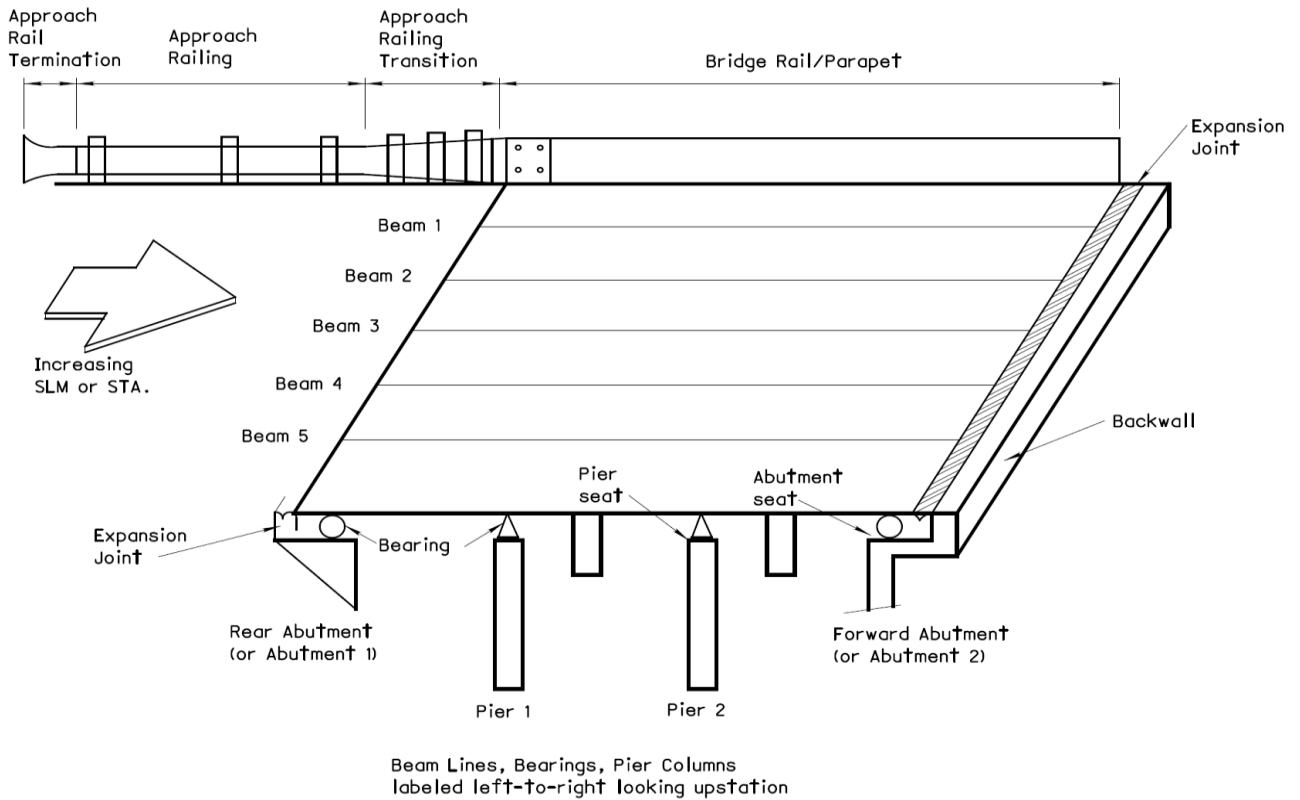

6. For non-highway structures (pedestrian, railroads, conveyor belts, etc.) over highways, the south or the west abutment shall be the rear abutment looking in the cardinal direction. For example, an overhead over a Northbound Cardinal route would have the following designation:

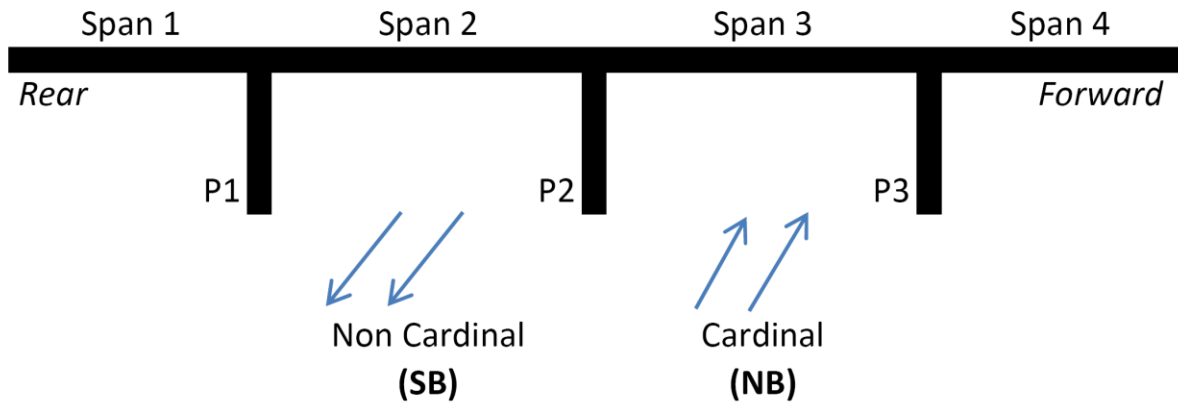

## Ohio Bridge Inventory Guide

---

7. The differences among the three: Substructure Slope Protection, Approach Embankment and Channel Protection
  - a. Slope protection is underneath the “shadow” of the structure protecting the substructure slope.
  - b. Channel protection is the protected embankment of the stream both upstream and downstream.
  - c. Approach Embankment is the sloped earth up to the roadway generally behind the wing wall. For culverts it includes the portion of the earth above the structure or “fill”.

# Ohio Bridge Inventory Guide

---

## STRUCTURE INVENTORY CODING INSTRUCTIONS

Following is a complete listing of all items occurring in the AWS. Items are described in detail to allow easy coding of structures by all the agencies involved. Since all items do not apply to all bridges, it is necessary that each description be read carefully. Each item should be coded in its entirety exactly as described.

**For instructions on coding Bridge Inspection forms, refer to ODOT Bridge Inspection Manual.**

## National Bridge Inventory (NBI) Items

### NBI #1 – State Code

It is a 3 digits code. The first two (2) digits are the Federal Information Processing Standards (FIPS) code for States, and the third (3) digits is the FHWA region code.

*This item is coded in the AWS by the ODOT CO at the time of activation of bridge inventory. All bridges in Ohio shall have State Code “395.”*

### NBI #2 – Highway Agency District

It is a 2 digits code. The highway agency district in which the bridge is located shall be represented by a two (2) digit code.

*Use the drop-down menu in the AWS to code the District in which bridge is located.*

<b>ODOT District</b>	<b>District Headquarters Location</b>	<b>Code</b>
District 1	Lima	01
District 2	Bowling Green	02
District 3	Ashland	03
District 4	Akron	04
District 5	Jacksontown	05
District 6	Delaware	06
District 7	Sidney	07
District 8	Lebanon	08
District 9	Chillicothe	09
District 10	Marietta	10
District 11	New Philadelphia	11
District 12	Garfield Heights	12

### NBI #3 – County (Parish) Code

Counties shall be identified using the Federal Information Processing Standards (FIPS) codes given in the current version of the **Census of Population and Housing – Geographic Identification Code Scheme**.

# Ohio Bridge Inventory Guide

---

Use the drop-down menu in AWS to code the County in which the start point of the bridge is located. A bridge can have one County Code. For bridges straddling county line between two or more counties, a consensus of all stakeholders must be formed.

Refer to **Appendix A** for county codes for Ohio.

## **NBI #4 - Place Code (FIPS)**

Cities, towns, townships, villages, and other census-designated places shall be identified using the Federal Information Processing Standards (FIPS) codes given in the current version of the **Census of Population and Housing – Geographic Identification Code Scheme**. If there is no FIPS Place code, then code all zeros.

All highway bridges in Ohio must have a FIPS code assigned in AWS based on the start point of the bridge. Refer to **Appendix B** for 5 (five) digit FIPS codes.

## **NBI #5 - Inventory Route**

The Inventory route is any route along which bridges/structures are being inventoried. Where possible, bridges should be **inventoried on the highway route carried on the bridge**. A bridge is to be inventoried only once and by only one (1) agency. When a non-highway route (Railway, Bikeway, Pedestrian, conveyor belt, etc.) is carried on the structure, then it should be inventoried on the highway route under the structure.

When two (2) or more routes are concurrent (overlapped), the highest of the hierarchy of systems as shown under Item 5B shall be used (Interstate highway has the highest hierarchy of all). Route selected under these rules are commonly known as the “Preferred route”.

<b><u>Segment</u></b>	<b><u>Description</u></b>	<b><u>Length</u></b>
5A	Record Type	1 digit
5B	Route Signing Prefix	1 digit
5C	Designated Level of Service	1 digit
5D	Route Number	5 digits
5E	Directional Suffix	1 digit

## **NBI # 5A - Record Type (On/Under)**

Enter the proper code to indicate if the route is carried by the structure or goes under it.

If there are two (2) or more physically separate routes under a structure you must inventory each route, using the same “Structure File Number” and coding appropriate A thru C “under” code for each route under the bridge. The Inventory route can never be coded “B” or “C”. It may be coded as “A” only under special circumstances when one (1) of the multiple routes under the bridge is the inventory route.

<b><u>Code</u></b>	<b><u>Description</u></b>
1	Route carried “on” the structure

# Ohio Bridge Inventory Guide

2	Single route goes “under” the structure
A-Z	Multiple routes go “under” the structure
A	Signifies the first of multiple routes under the structure
B	Signifies the second of multiple routes under the structure

“On” signifies that the inventory route is carried “on” the structure. Each bridge structure carrying highway traffic must have a record identified with a type code = 1 (numeric).

“Under” signifies that the inventory route goes “under” the structure. If an inventory route beneath the structure is on the National Highway System, is a defense route or is otherwise important, a record must be coded to identify it. The type code must be 2 or alphabetic letter A through C. When there is a single route under the bridge, code 2. If 2 or more routes go under a structure on separate roadways, the code of 2 shall not be used. Code **A, B, or C** consecutively for multiple routes on separate roadways under the same structure. For a non-highway system, structure (pedestrian, railroad, etc.), the most significant roadway should be coded “A” in the Inventory route and “B” and/or “C” as the Intersecting route.

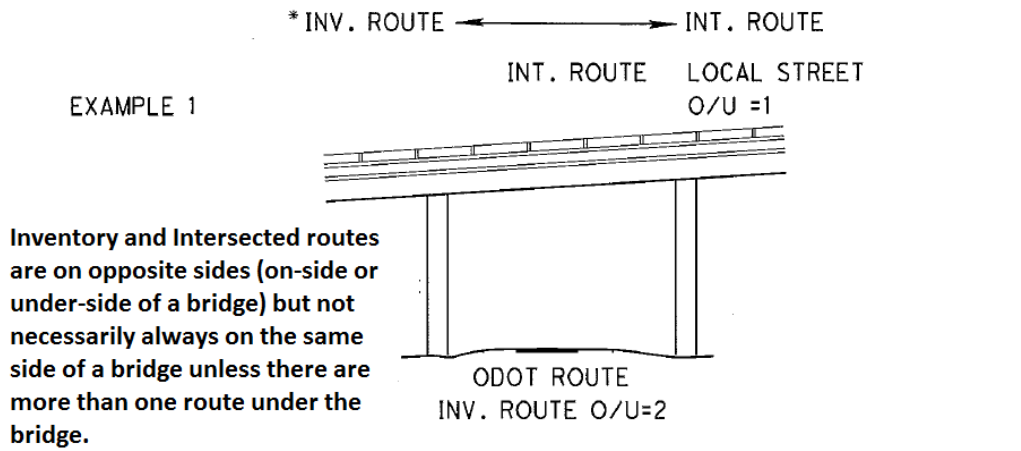



# Ohio Bridge Inventory Guide

---

## NBI # 5B – Route Signing Prefix (Highway System)

Identify the route signing prefix (highway system) for the inventory route. Where possible, structures should be inventoried ***on the route*** carried on the structure. When the Inventory Route is under the bridge (e.g., in case of a railway overhead bridge) the inventory will progress from the most important routes to the least important, by established hierarchy in the table below. A structure is to be inventoried only once and only by one (1) agency.

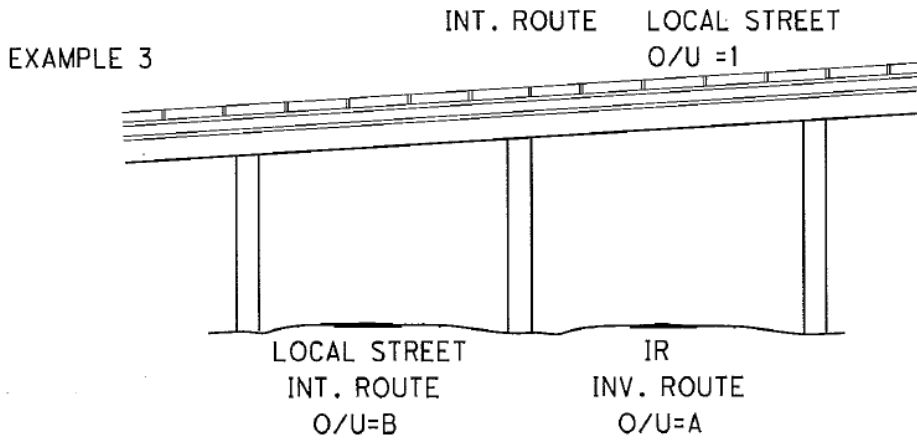
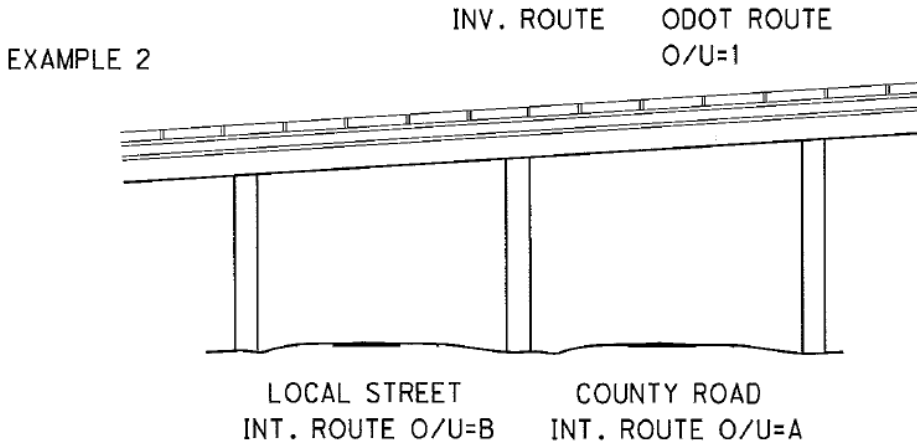

Code	Description
1	Interstate highway
2	U.S. numbered highway
3	State highway
4	County highway*
5	City street
6	Federal lands road
7	State lands road
8	Other (include toll roads not otherwise indicated or identified above)

# Ohio Bridge Inventory Guide

---

\*Township roads are coded same as County highways

If 2 or more routes are concurrent, the highest class of route will be used. The hierarchy is in the order listed above. When two or more routes with the same hierarchy overlap, the route with the lower number will be used to inventory a bridge.

When no highway system road from the table above is “on” or “under” a bridge then the Highway System must be coded as “0”. When Item 5B is coded as “0” the Item 26 must be coded as “00”. A bridge with Item 5B coded as “0” will not be a NBI bridge and its data will not be included in the NBI tape.

## **NBI #5C - Designated Level of Service (Highway Designation)**

Identify the designated level of service (Highway designation) for the inventory route using one (1) of the following codes:

<b>Code</b>	<b>Description</b>
0	None of the below
1	Mainline
2	Alternate
3	Bypass
4	Spur
5	Toll Road
6	Business
7	Ramp, Wye, Connector, etc.
8	Service and/or unclassified frontage road

Generally county and township roads and municipal streets are coded as mainline.

## **NBI #5D - Route Number**

The official Route Number as shown on the State’s Straight Line Mileage diagrams or in the roadway inventory or posted in the records of the Agency involved, shall be coded and right justified in the five (5) available positions using leading zeros where necessary the route number will normally have one (1) or more digit numeric. A single letter code must be added to the route numeric in the last digit position only for routes, designated as Alternate, Directional Alternate, Bypass, etc. (See Appendix G for official letter codes to be used for such routes), these codes have no directional connotation and must be coded in the fifth position of the five (5) character field. Meaningful abbreviations for street and road names should be used by local agencies, for those streets or local roads without an established system route number.

**For special off-highway system bridges, the fourth (4) and fifth (5) digit locations of the route number must be coded with a standardized alphabetic two (2) character suffix which identifies the public complex in which the bridge is located.**

Example: State Park – SP

# Ohio Bridge Inventory Guide

---

## NBI #5E - Directional Suffix

Code the directional suffix to the route number when one (1) is part of the route number. Leave blank if not applicable.

<u>Code</u>	<u>Description</u>
0	Not applicable
1	North
2	East
3	South
4	West

## NBI #6 - Feature Intersected

The information for this item shall be the name or names of features intersected by the Inventory route ***at the structure***. When a highway is one (1) of the features intersected the number of such highway (e.g., I.R. 71, C.R. 16, and S.R. 5) should be coded if known, then the local name or names of the route (Mill Rd., Stone Street, etc.). If other features such as streams, canals and railroads are crossed, they should be coded next. If a bridge is closed to all traffic, code the word “closed” in parenthesis after the features description.

## NBI #7 - Facility Carried by Structure

The facility being carried by the structure shall be recorded and coded. This item describes the use “on” the structure. Left justify without trailing zeros and use meaningful abbreviations when necessary.

## NBI #8 - Structure File Number (SFN)

It is required that the official structure number be recorded. The structure must be unique for each bridge within the State, and once established should preferably never change for the life of the bridge. For any structure number changes, a complete cross reference of corresponding “old” and “new” numbers must be provided to the FHWA Bridge Division.

When recording and coding for this item, any structure or structures with a closed median should be considered as **one** structure, not **two**. Closed medians may have either mountable or non-mountable curbs or barriers.

## NBI #9 - Location

This item gives a description of the bridge location. The location should be keyed to some recognizable feature on the official highway map, (county map for county, township or municipal structures), such as road junctions and topographical features (using meaningful abbreviations when necessary).

## NBI #10 - Inventory Route, Minimum Vertical Clearance

This item is automatically filled in by the larger of the vertical clearances on the cardinal and non-cardinal sides of the route entered in items #53 and #336. It gives the practical maximum clearance.

# Ohio Bridge Inventory Guide

## NBI # 11 - Mile-point

This item is for all structures.

Code the County Log Point (CLP) in miles at the start of the bridge. The County Log Point shall be obtained from the centerline of the route on the bridge at the end of the rear approach slab or start of the bridge limits traveling in the increasing direction of the CLP. In the case of an overhead bridge or when obtaining the CLP for the Intersected Route, the CLP should be obtained from the centerline of the route under the bridge at the first bridge edge traveling in the increasing direction of the CLP. Code the appropriate County Log Point in miles measured to three decimal places.

TIMS can be used to obtain CLP of a bridge.

**Example: CLP or SLM= 0.51 miles      Code: 00.510**

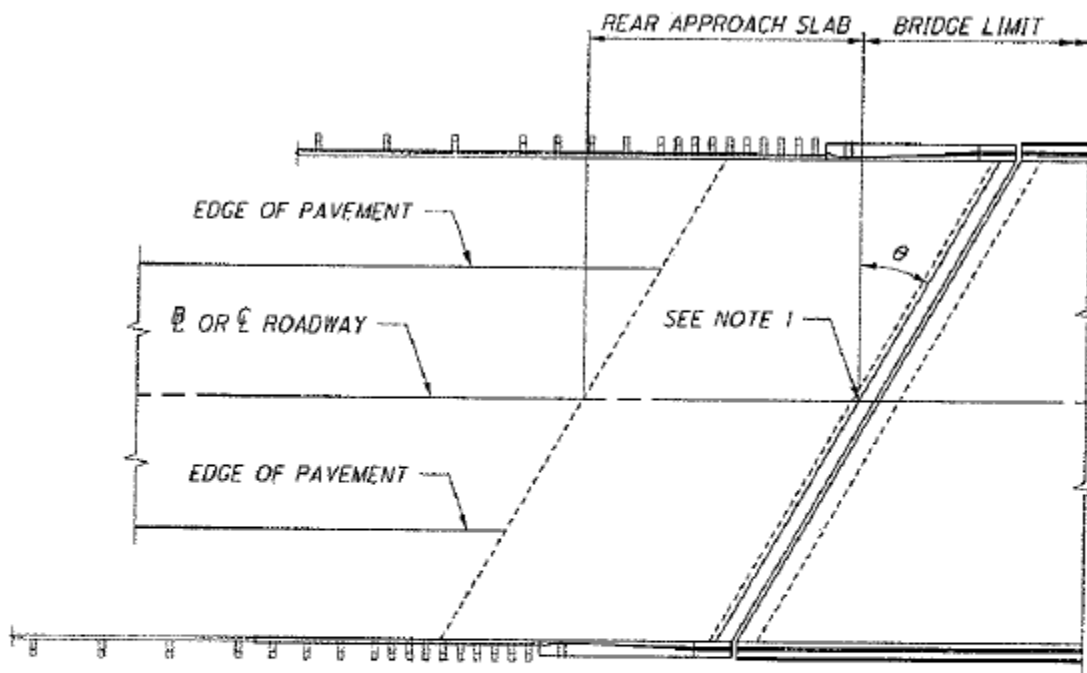

$\theta$  : SKEW ANGLE

NOTE 1:

FOR STRUCTURES WITH APPROACH SLAB, THE POINT WHERE BASELINE OR CENTERLINE OF ROADWAY INTERSECTS THE END OF THE REAR APPROACH SLAB IS THE LOCATIONS FOR SLM (MEASURED TO THREE DECIMAL POINTS), LATITUDE AND LONGITUDE BRIDGE COORDINATES (MEASURED TO SIX DECIMAL POINTS).

FOR STRUCTURES WITHOUT APPROACH SLAB, THE POINT WHERE BASELINE OR CENTERLINE OF ROADWAY INTERSECTS THE END OF THE REAR ABUTMENT BACKWALL IS THE LOCATIONS FOR SLM (MEASURED TO THREE DECIMAL POINTS), LATITUDE AND LONGITUDE BRIDGE COORDINATES (MEASURED TO SIX DECIMAL POINTS).

# Ohio Bridge Inventory Guide

## NBI # 12 - Base Highway Network

The Base Highway Network includes the through lane (mainline) portions of the NHS, rural/urban principal arterial system and rural minor arterial system. Ramps, frontage roads and other roadways are not included in the Base Network. For the inventory route identified in Item 5, indicate whether the inventory route is on the Base Highway Network or not on that network. Use one of the following codes:

Code	Description
0	Inventory Route <b>is not</b> on the Base Network
1	Inventory Route <b>is</b> on the Base Network

## NBI # 13 - A - LRS Inventory Route, B - Subroute Number

Leave blank.

## NBI #14 and NBI #15 - Reserved

Do not use.

## NBI # 16 - Latitude

Code the latitude of the bridge.

*Code the Latitude coordinate on the centerline of the route on the bridge at the end of the rear approach slab or start of the bridge limits traveling in the increasing direction of the Straight Line Mileage (SLM) or the County Log Point (CLP). In case of an overhead bridge, the coordinates shall be measured on the centerline of the inventory route under the bridge at the first bridge edge travelling in the increasing direction of the SLM or CLP. For culverts/frames under fill the coordinates shall be measured at the back of the first wall travelling in the increasing direction of the SLM or CLP.*

*This item can only be edited graphically. Go to "Show on Map" and drag the marker to the start of the bridge location.*

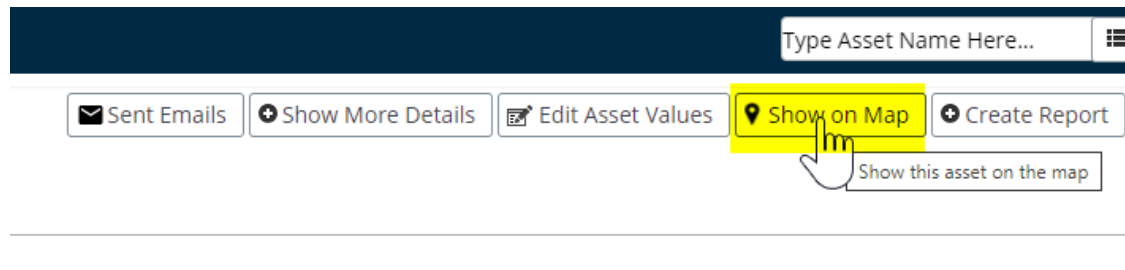

# Ohio Bridge Inventory Guide

---



# Ohio Bridge Inventory Guide

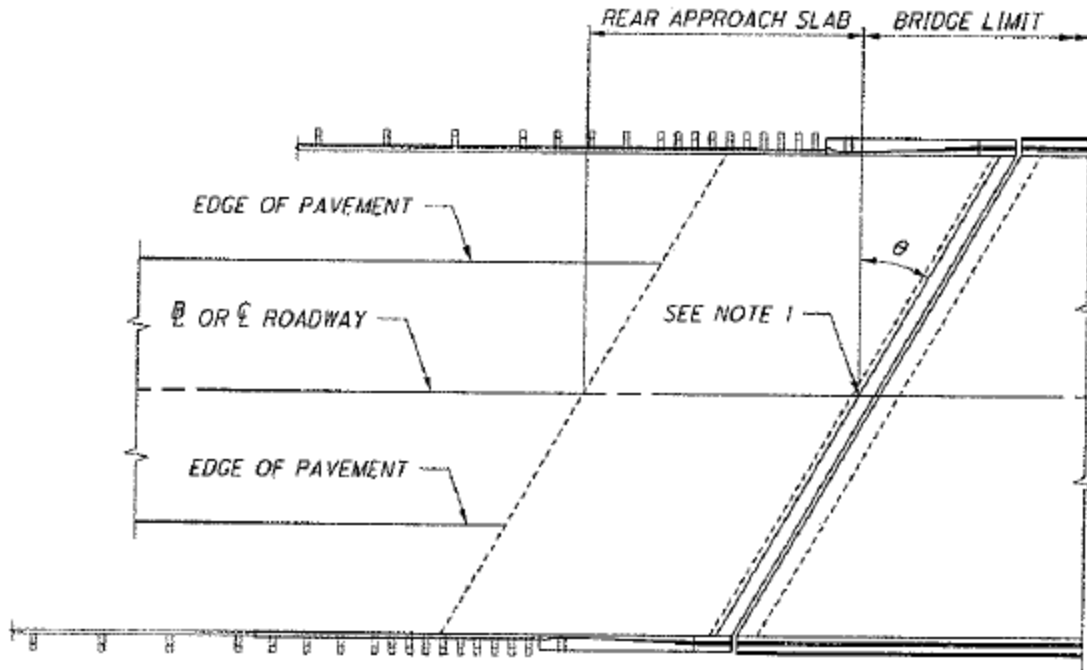

$\theta$  : SKEW ANGLE

## NOTE 1:

FOR STRUCTURES WITH APPROACH SLAB, THE POINT WHERE BASELINE OR CENTERLINE OF ROADWAY INTERSECTS THE END OF THE REAR APPROACH SLAB IS THE LOCATIONS FOR SLM (MEASURED TO THREE DECIMAL POINTS), LATITUDE AND LONGITUDE BRIDGE COORDINATES (MEASURED TO SIX DECIMAL POINTS).

FOR STRUCTURES WITHOUT APPROACH SLAB, THE POINT WHERE BASELINE OR CENTERLINE OF ROADWAY INTERSECTS THE END OF THE REAR ABUTMENT BACKWALL IS THE LOCATIONS FOR SLM (MEASURED TO THREE DECIMAL POINTS), LATITUDE AND LONGITUDE BRIDGE COORDINATES (MEASURED TO SIX DECIMAL POINTS).

## NBI # 17 - Longitude

Code the longitude of the bridge.

Code the longitude coordinate on the centerline of the route on the bridge at the end of the rear approach slab or start of the bridge limits traveling in the increasing direction of the Straight Line Mileage (SLM) or the County Log Point (CLP), i.e., Cardinal direction. In the case of an overhead bridge, the coordinates shall be measured on the centerline of the inventory route under the bridge at the first bridge edge travelling in the increasing direction of the SLM or CLP. For culverts/frames under fill the coordinates shall be measured at the back of the first wall travelling in the increasing direction of the SLM or CLP.

# Ohio Bridge Inventory Guide

This item can only be edited graphically. Go to "Show on Map" and drag the marker to the start of the bridge location.

Type Asset Name Here...

Sent Emails Show More Details Edit Asset Values **Show on Map** Create Report

Show this asset on the map





# Ohio Bridge Inventory Guide

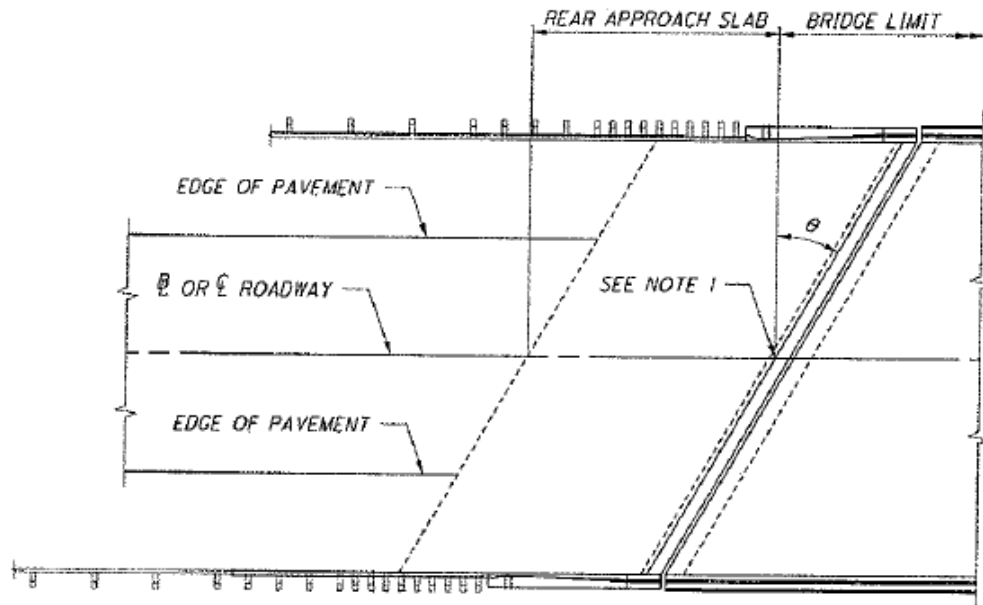

$\theta$  : SKEW ANGLE

**NOTE 1:**

FOR STRUCTURES WITH APPROACH SLAB, THE POINT WHERE BASELINE OR CENTERLINE OF ROADWAY INTERSECTS THE END OF THE REAR APPROACH SLAB IS THE LOCATIONS FOR SLM (MEASURED TO THREE DECIMAL POINTS), LATITUDE AND LONGITUDE BRIDGE COORDINATES (MEASURED TO SIX DECIMAL POINTS).

FOR STRUCTURES WITHOUT APPROACH SLAB, THE POINT WHERE BASELINE OR CENTERLINE OF ROADWAY INTERSECTS THE END OF THE REAR ABUTMENT BACKWALL IS THE LOCATIONS FOR SLM (MEASURED TO THREE DECIMAL POINTS), LATITUDE AND LONGITUDE BRIDGE COORDINATES (MEASURED TO SIX DECIMAL POINTS).

## NBI #18 - Reserved

Do not use.

## NBI # 19 - Bypass, Detour Length

Indicate the actual detour length. The detour length should represent the total additional travel for a vehicle which would result from closing of the bridge. The factor to consider when determining if a bypass is available at the site is the potential for moving vehicles, including military vehicles, around the structure. This is particularly true when the structure is in an interchange. For instance, a bypass likely would be available in the case of diamond interchanges, interchanges where there are service roads available, or other interchanges where the positioning and layout of the ramps is such that they could be used without difficulty to get around the structure. If a ground level bypass is available at the structure site for the inventory route, record and code the detour length as 000.

If the bridge is one of twin bridges and is not at an interchange, code 001 where the other twin bridge can be used as a temporary bypass with a reasonable amount of crossover grading. The detour route will be established following allowable criteria determined by the governing authority. (Some authorities will not allow a designated detour over a road or bridge of lesser "quality.") Code 199 for 199 miles or more.

# Ohio Bridge Inventory Guide

The bypass or detour length should be determined with respect to the **route**. Indicate the detour distance or extra length of travel to the nearest mile using the shortest temporary "Alternate" routes having comparable structures. The detour length should be coded to represent **only the total additional travel** (see also Appendix "F") for a vehicle which would result from closing of the bridge. Use zero for railroad, pedestrian walk, pipeline, etc., since they do not carry highway traffic.

<b>Code</b>	<b>Examples</b>
00	<i>Diamond interchange, structure by-passable</i>
08	<i>Cloverleaf, not by-passable, 8 mile detour</i>
99	<i>Structure over river, 121 mile detour</i>
00	<i>Railroad structure over highway (Inventory route), by-passable</i>
199	<i>On dead end road, no detour possible</i>

## BYPASS (DETOUR) LENGTH

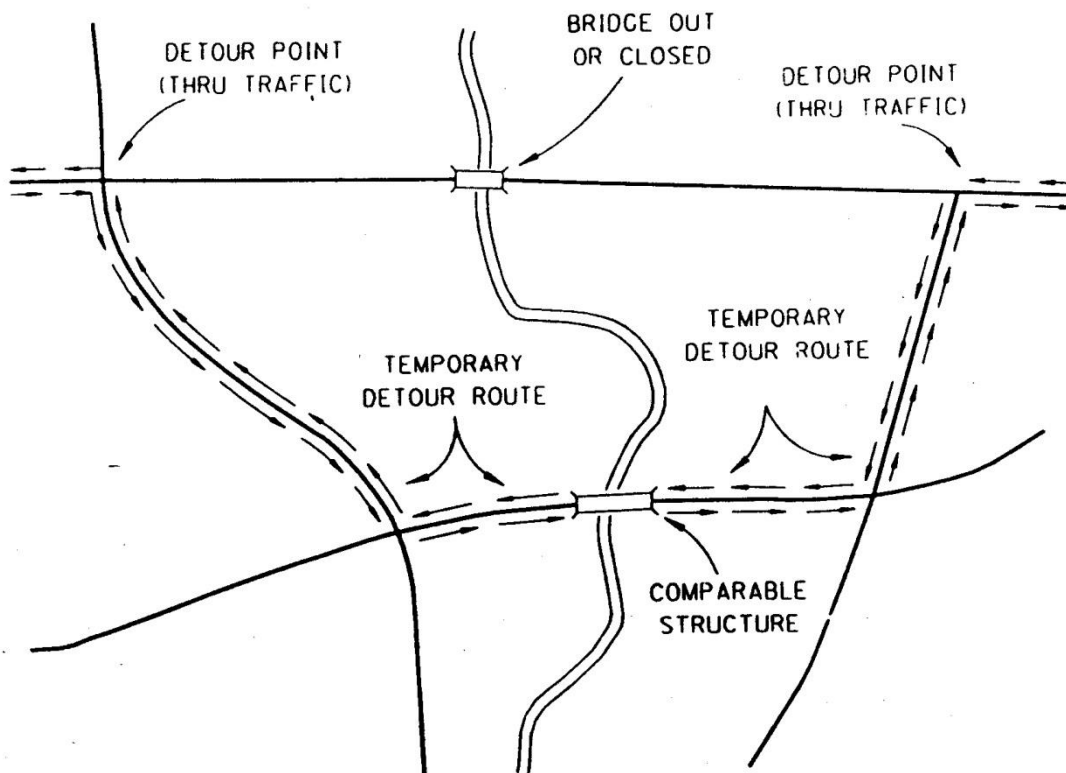

# Ohio Bridge Inventory Guide

---

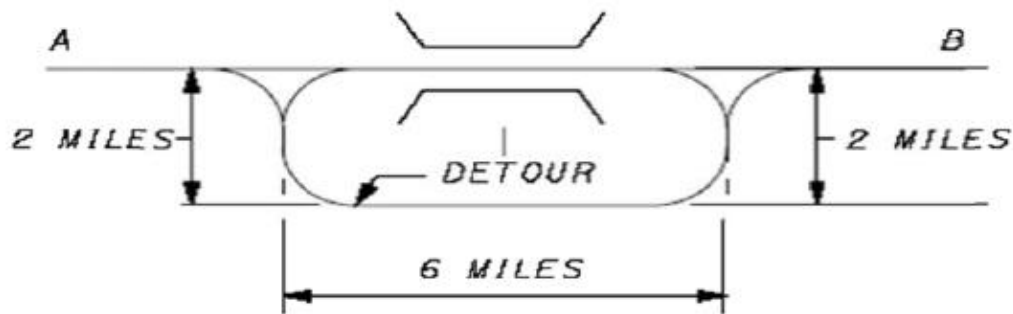

*BYPASS, DETOUR LENGTH A TO B - 4 MI.*

## NBI #20 - Toll

The toll status of the structure is indicated by this item. Interstate toll segments under Secretarial Agreement (Title 23 - United States Code - Highways Section 129 as amended by 1991 ISTEA and prior legislation) shall be identified separately.

Code	Description
1	Toll Bridge. Tolls are paid specifically to use the structure.
2	On toll road. The structure carries a toll road, that is, tolls are paid to use the facility, which includes both the highway and structure.
3	On free road. The structure is toll-free and carries a toll-free highway.
4	On Interstate toll segment under Secretarial Agreement. Structure functions as a part of the toll segment.
5	Toll bridge is a segment under Secretarial Agreement. Structure is separate agreement from highway segment.

*Use the proper code from the table.*

## NBI #21 - Maintenance Responsibility

The actual name(s) of the agency(s) responsible for the maintenance of the structure shall be recorded. The codes below shall be used to represent the type of agency that has primary responsibility for maintaining the structure. If more than one agency has equal maintenance responsibility, code one agency in the hierarchy of State, Federal, county, city, railroad, and other private.

# Ohio Bridge Inventory Guide

---

For bridges in Ohio, the agency legally responsible for the Major Maintenance of the bridges should be coded. The agency legally responsible should be coded in accordance with the Ohio Revised Code, Roadway Infrastructure Maintenance Responsibility Manual or by legal agreement. For reference, See RIMR at the following URL:

(<http://portal.dot.state.oh.us/Divisions/Operations/MaintAdmin/Reference%20Materials/RIMR.pdf#search=rimr>)

Code	Description
01	State Highway Agency (ODOT)
02	County Highway Agency
03	Town or Township Highway Agency
04	City or Municipal Highway Agency
11	State Park, Forest or Reservation Agency (ODNR)
12	Local Park, Forest or Reservation Agency
21	Other State Agencies
25	Other Local Agencies
26	Private (other than railroad)
27	Railroad
31	State Toll Agency (OTP)
32	Local Toll Agency
60	Other Federal Agencies (not listed below)
61	Indian Tribal Government
62	Bureau of Indian Affairs
63	Bureau of Fish and Wildlife
64	U. S. Forest Service
66	National Park Service
67	Tennessee Valley Authority
68	Bureau of Land Management
69	Bureau of Reclamation
70	Corps of Engineers (Civil)
71	Corps of Engineers (Military)
72	Air Force
73	Navy/Marines
74	Army
75	NASA
76	Metropolitan Washington Airports Service
80	Unknown

## NBI #22 – Owner

The actual name(s) of the owner(s) of the bridge shall be recorded on the inspection form. The codes used in Item 21 – Maintenance Responsibility shall be used to represent the type of agency that is the primary owner of the structure. If more than one agency has equal ownership, code one agency in the hierarchy of State, Federal, county, city, railroad, and other private.

# Ohio Bridge Inventory Guide

---

For all bridges in Ohio, code NBI #22 same as NBI #21.

## NBI #23, NBI #24 and NBI #25 - Reserved

Do not use.

## NBI #26 - Functional Classification of Inventory Route

Use the appropriate functional classification code of the inventory route from the drop-down list. This item **cannot be coded without first referencing the applicable Functional Classification Map**. These maps are available through the Department of Transportation Planning Offices or on the Planning website.

<http://www.dot.state.oh.us/Divisions/Planning/ProgramManagement/MajorPrograms/Pages/RoadwayFunctionalClass.aspx>

Code Item 26 – Functional Classification = 00 only when Item 5B Highway System Code = 0. If 5B – Highways code is coded other than zero, Item 26 must be coded per one of codes below:

A bridge shall be coded Rural if not inside a designated Urban area.

### Rural

<u>Code</u>	<u>Description</u>
01	Principal Arterial – Interstate
02	Principal Arterial – Other
06	Minor Arterial
07	Major Collector
08	Minor Collector
09	Local

### Urban

<u>Code</u>	<u>Description</u>
11	Principal Arterial – Interstate
12	Principal Arterial – Other Freeways or Expressways
14	Other Principal Arterial
16	Minor Arterial
17	Collector
19	Local

## NBI #27 - Year Built

The year when bridge was first built will be shown here.

# Ohio Bridge Inventory Guide

---

## NBI #28 – Lanes On and Lanes Under

The number of lanes should be coded right justified in each field with leading zero(s) coded as required. If there is no highway over or under a structure, code all zeros in the appropriate field. Where there are no lane markings on a roadway, code number of lanes as intended to carry through the traffic.

Include all lanes carrying highway traffic (i.e., cars, trucks, busses) which are striped or otherwise operated as full width traffic lanes for the entire length of the structure or under the structure. This should include any full width merge lanes and ramp lanes, and shall be independent of directional usage (i.e., a one (1) lane bridge carrying two (2)-way directional traffic is still considered to carry only one (1) lane on the structure).

When an inventory route is over or under a non-highway obstruction (railroad, pedestrian, pipeline, etc.), code 00 in the appropriate segment for the non-highway obstruction. For example, when the inventory route is “under” the structure carrying railway tracks, code 00 for the railway bridge over the highway.

If a double deck bridge is coded as one (1) structure, code total number of lanes on both decks as noted in the examples below:

## NBI #28A – Lanes On

Code the number of lanes of traffic being carried by the structure.

<u>Code</u>	<u>Examples</u>
16	16 lanes on the structure
04	4 lanes on the structure
00	Railroad or pedestrian on the structure
10	5 lanes on the structure double deck each direction

## NBI #28B – Lanes Under

Code the number of lanes of traffic being crossed over by the structure.

<u>Code</u>	<u>Examples</u>
00	0 lanes under the structure
02	2 lanes under the structure
04	4 lanes under the structure
10	10 lanes under the structure

## NBI #29 – Average Daily Traffic (ADT)

Code an eight (8) digit numeric that shows the average daily traffic volume for the Inventory route identified in Item 5. The ADT codes shall be the most recent ADT counts available. Use your best estimate of the traffic volume where an actual count is not available. In coding traffic counts for parallel Left and Right bridges on Multi-lane divided highways, (physically separate structures filed under different

# Ohio Bridge Inventory Guide

---

Structure File Numbers) code half the official route traffic count for each bridge. ***If the bridge is closed, code the actual ADT before the closure occurred.*** If Item 5B Highway System = 0 for non-highway related traffic, code ADT all zero's. The ADT must be compatible with the other items coded for the bridge. For example, parallel bridges with median are coded as follows: If lanes On and Under the Structure and Bridge Roadway width is coded for each bridge separately, then the ADT must be coded for each bridge separately (not the total ADT for route).

**Examples:**

Traffic Volume	Code
540	00000540
1560	00001560
24000	00024000
893	00000893

### **NBI #30 – Year of Average Daily Traffic**

Code the four (4) digits of the year of the Average Daily Traffic Count on the inventory route used in Item 30. The year of ***ADT needs to be within last 4 years.***

### **NBI #31 – Design Load**

Code for all structures the live load for which the structure was designed. For most of the structures the Design Load can be taken directly from the plans. Classify any non-standard loading, when feasible, using the nearest equivalent of the (AASHTO) H-loadings give below:

Code	Description
0	Unknown
1	H 10
2	H 15
3	HS 15
4	H 20
5	HS 20
6	HS 20-44 + Mod
7	Pedestrian
8	Railroad
9	HS 25 or greater
A	HL 93
B	Greater than HL 93
C	Other (includes railroad bridges w/track removed)

### **NBI #32 – Approach Roadway Width**

This item should be coded for all structures with reference only to the roadway carried by the structure. Code a three (3) digit number to the nearest foot which represents the normal width of the roadway approaching the structure. This dimension will include the widths of the usable shoulders. For paved approach medians, the median width at the normal point should be included in this dimension. For

## Ohio Bridge Inventory Guide

---

multiple lane divided highways, where separate parallel bridges carry each direction of traffic, code only that portion, of the approach roadway width which applies to each bridge. Code the shoulders and directional pavement, ignoring unpaved median widths. When there is a variation between the approaches at either end of the structure, record and code the most restrictive of the approach conditions. If item does not apply, code all zeros. If a ramp is adjacent to the through lanes approaching the structure, it shall be included in the approach roadway with.

<u>Left Shoulder/Roadway</u>	<u>Median</u>	<u>Right Roadway/Shoulder</u>	<u>Code</u>
4.0/00.0	00.0	16.0/06.0	26.00
6.0/00.0	00.0	36.0/12.0	54.00
12.0/48.0	00.0	48.0/12.0	120.00
10.0/24.0	16.0	36.0/10.0	96.00

### NBI #33 – Bridge Median

Indicate if the median is non-existent, open or closed. The median is closed when the area between the two (2) roadways at the structure is bridged over and is capable of supporting traffic. All bridges that carry either one (1)-way traffic or two-way traffic separated only by a centerline will be coded N for no median.

This item must be coded with the appropriate code from the list below:

<u>Code</u>	<u>Description</u>
0	No median
1	Open median
2	Closed median (no barrier)
3	Closed median with non-mountable barriers

### NBI #34 – Skew

The skew angle is the angle between the centerline of a pier or abutment or a pipe and a line normal to the roadway centerline. When plans are available, the skew angle can be taken directly from the plans. If no plans are available, the angle is to be field measured, if possible.

The skew should be coded to the nearest degree. When the structure is on a curve or if the skew varies for some other reason, the average skew should be coded, if reasonable. Otherwise, code “99” to indicate a major variation in skews of sub-structure units. If the structure is not skewed code zeros. Always code a two (2) digit numeric using leading zeros where necessary.

<u>Skew</u>	<u>Code</u>
10 degrees	10
8 degrees	08
29 degrees	29



# Ohio Bridge Inventory Guide

---

## NBI #35 – Structure Flared

This item is coded to indicate whether or not the width of the structures varies. Generally, such variance will result from ramps converging with or diverging from the through lanes on the structure, but there may be other causes. Minor flares at ends of structures should be ignored.

<u>Description</u>	<u>Code</u>
No flare	0
Yes, flared	1

## NBI #s 36A, B, C, & D – Traffic Safety Features

See Manual of Bridge Inspection

## NBI #37 – Historical Significance Code

The historical significance of a bridge involves a variety of characteristics: the bridge may be a particularly unique example of the history of engineering; the crossing it's self might be significant; the bridge might be associated with a historical property or area; or historical significance could be derived from the fact the bridge is associated with significant events or circumstances. Use one (1) of the following codes:

<u>Code</u>	<u>Description</u>
1	Bridge is on the National Register of Historic Places
2	Bridge is eligible for the National Register of Historic Places
3	Bridge is possibly eligible for the National Register of Historic Places (requires further investigation before determination can be made) or bridge is on a State or local historic register
4	Historical significance is not determinable at this time
5	Bridge is not eligible for the National Register of Historic Places

*Currently, this item in AWS cannot be coded directly. It depends on the coding of Ohio Item 826.*

## NBI #38 – Navigation Control

Indicate for this item whether or not navigation control exists. The determination of whether or not a water course is navigable is made by the U.S. Coast Guard or U.S. Army Corps of Engineers, whoever has the authority or control.

<u>Code</u>	<u>Description</u>
N	Not applicable, no waterway.
0	No navigation control on waterway (permit not required).
1	Navigation control on waterway (bridge permit required).

## NBI #39 – Navigation Vertical Clearance

If Item 38 – Navigation Control has been coded “1”. This item must be coded. Record to the nearest foot the minimum vertical clearance imposed at the site as measured above a datum that is specified on navigation permits issued by a control agency. The measurement will show the clearance that is allowable

# Ohio Bridge Inventory Guide

---

for navigation purposes. In the case of a swing or bascule bridge, the vertical clearance shall be measured with the bridge in the closed position (i.e., open to vehicular traffic). If Item 38 – Navigation Control is coded “0”, or if a permit has not been issued to establish the clearances, code all zeros to indicate not applicable.

**Examples:**

<u>Actual</u>	<u>Code</u>
150.0	150.00
20.6	20.60

## **NBI #40 – Navigation Horizontal Clearance**

If NBI # 38 - Navigation Control is coded “1”; this item must be coded for the minimum horizontal clearance to the nearest foot. This measurement should be that shown on a navigation permit and may be less than the structure allows. If NBI # 38 – Navigation Control is coded “0”, or if a permit has not been issued to establish the clearances, code all zeros to indicate not applicable.

## **NBI #41 – Structure Open, Posted, or Closed to Traffic**

**This Item can only be coded during an inspection.** Please refer to the Manual of Bridge Inspection

This item provides information about the actual operational status of a structure. The field review could show that a structure is posted, but Item 70 – Bridge Posting may indicate that posting is not required. This is possible and acceptable coding since Item 70 is based on the operating stress level and governing agency’s posting procedures that may specify posting at some stress level less than the operating rating. One (1) of the following codes shall be used:

<u>Code</u>	<u>Description</u>
A	Open, no restriction
B	Open, posting recommended but not legally implemented (all signs not in place or not correctly implemented)
D	Open, would be posted or closed except for temporary shoring, etc. to allow for unrestricted traffic
E	Open, temporary structure in place to carry legal loads while original structure is closed and awaiting replacement or rehabilitation
G	New structure not yet open to traffic
K	Bridge closed to all traffic
P	Posted for load (may include other restrictions such as temporary bridges which are load posted)
R	Posted for other load-capacity restriction (speed, number of vehicles on bridge, etc.)

Bridges under construction with portions of the bridge open to traffic (example: part-width construction) shall be coded “A”. Any bridges that are below 100% Legal must be posted (Operating

## Ohio Bridge Inventory Guide

---

Status = P) or be recommended for posting (Operating Status = B). Note that in the case of at code “**B**”, ***you have 90 days from the date of the inspection to put the posting sign up.*** The Operating Status can stay a “B” until the next regular inspection, where it must be changed from code “B” to Code “P”, unless work has been performed to correct the issue causing the bridge to be posted.

### NBI #42A – Type of Service On

This item is intended to show the type of service on the bridge. Use appropriate code from the table below.

<u>Code</u>	<u>Description</u>
1	Highway
2	Railroad
3	Pedestrian-bicycle
4	Highway-railroad
5	Highway-pedestrian
6	Overpass structure at an interchange or second level of a multilevel interchange
7	Third level (Interchange)
8	Fourth level (Interchange)
9	Building or plaza
0	Other

### NBI #42B – Type of Service Under

This item is intended to show the type of service under the bridge. Use appropriate code from the table below.

<u>Code</u>	<u>Description</u>
1	Highway, with or without pedestrian
2	Railroad
3	Pedestrian-bicycle
4	Highway-railroad
5	Waterway
6	Highway-waterway
7	Railroad-waterway
8	Highway-waterway-railroad
9	Relief for waterway
0	Other

### NBI #43 –Structure Type - Main

Record the description and indicate the type of structure for the main span(s) with a 3-digit code composed of 2 segments.

NBI #43A	Kind of material and/or design	1 digit
NBI #43B	Type of design and/or construction	2 digits

# Ohio Bridge Inventory Guide

---

The first digit indicates the kind of material and/or design and shall be coded using one of the following codes:

NBI #43A - Code	Description
1	Concrete
2	Concrete continuous
3	Steel
4	Steel continuous
5	Prestressed concrete *
6	Prestressed concrete continuous *
7	Wood or Timber
8	Masonry
9	Aluminum, Wrought Iron, or Cast Iron
0	Other

\* Post-tensioned concrete should be coded as prestressed concrete.

The second and third digits indicate the predominant type of design and/or type of construction and shall be coded using one of the following codes:

NBI #43B - Code	Description
01	Slab
02	Stringer/Multi-beam or Girder
03	Girder and Floor beam System
04	Tee Beam
05	Box Beam or Girders - Multiple
06	Box Beam or Girders - Single or Spread
07	Frame (except frame culverts)
08	Orthotropic
09	Truss - Deck
10	Truss - Thru
11	Arch - Deck
12	Arch - Thru
13	Suspension
14	Stayed Girder
15	Movable - Lift
16	Movable - Bascule
17	Movable - Swing
19	Culvert (includes frame culverts)
20 *	Mixed types
21	Segmental Box Girder
22	Channel Beam
00	Other

\* Applicable only to approach spans - Item 44

# Ohio Bridge Inventory Guide

---

EXAMPLES:	Code
Wood or Timber Through Truss	710
Masonry Culvert	819
Steel Suspension	313
Continuous Concrete Multiple Box Girders	205
Simple Span Concrete Slab	101

All structures with two (2) or more lines of beams or girders (rolled or built-up) and without a floor system (i.e. floor beams, stringers, etc.) shall be coded as Multi-beam type bridges.

All Truss type bridges shall be coded either as X09 (Deck Truss) or X10 (Thru Truss).

Pony type bridges shall be coded as Thru Truss (310). See also Item #43C. No simple or continuous descriptions are permissible for these types of structures. Thru trusses generally have overhead steel members for bracing. Pony trusses are short in height and do not have top chord lateral bracings.

All Arch type bridges shall be coded as either X53 (Arch - Deck) or X54 (Arch - Thru) bridges. No simple or continuous descriptions are permissible for these types of structures.

Masonry and concrete filled-arch bridges shall be coded as X53 (Deck Arches). See Also Item #43C.

Culvert type bridges are structures which convey water or form a passageway through an embankment and are designed to support super-imposed loads of earth or other fill material plus the live load. Culverts may qualify to be considered "bridge" length. Corrugated Metal Pipe (CMPS) structures are considered culvert type structures and they must be coded as 319 (Steel Culvert).

When a bridge is coded as a X19 (Culvert), the summaries of the Deck (NBI # 58), Superstructure (NBI # 59) and Substructure (NBI # 60) shall all be coded as "N" during Inspection. Only Culvert (NBI # 62) summary shall be coded as a numeric value during the inspection.

A Jack Arch is defined as a deck support system comprised of a brick or concrete arch springing from the bottom flanges of adjacent rolled steel beams. There is not a Structure Type for Jack arches because the jack arch is actually a description of the deck, and this bridge is a special kind of steel beam bridge. Therefore you should code the structure type as a steel beam.

**Please note: Tunnels have been removed from the bridge inventory, as they are being inventoried under the separate Tunnel Inventory. If you believe you have a tunnel to inventory, please contact the Bridge Inventory Section in ODOT for assistance.**

## **NBI #44 - Structure Type - Approach**

Indicate by a three (3) digit code composed of 2 segments, the type of structure for approach spans to a major bridge or for the spans where the structural material is different. The codes are the same as for NBI #43. However code "000" if this item is not applicable. Use code 20 (NBI #44B) when no one type of design and/or construction is predominate for approach units. If the kind of material (NBI #44A) is varied, code the most predominant.

---

# Ohio Bridge Inventory Guide

---

## NBI #45 – Number of Spans in Main Unit

Record the number and indicate with a 3-digit number the number of spans in the main or major unit. This item will include all spans of most bridges, the major unit only of a sizable structure, or a unit of material or design different from that of the approach spans.

## NBI #46 – Number of Approach Spans

Record the number and indicate with a 4-digit number the number of spans in the approach spans to the major bridge, or the number of spans of material different from that of the major bridge.

## NBI #47 – Inventory Route, Total Horizontal Clearance

The total horizontal clearance for the inventory route identified in NBI #5 should be measured and recorded. The clearance should be the available clearance measured between the restrictive features -- curbs, rails, walls, piers or other structural features limiting the roadway (surface and shoulders). The measurement should be recorded and coded truncated to the nearest tenth of a *foot*. When the restriction is 100 *feet* or greater, code 99.9.

The purpose of this item is to give the largest available clearance for the movement of wide loads. Flush and mountable medians are not considered to be restrictions. This clearance is defined in 2 ways; use the most applicable:

1. Clear distance between restrictions of the inventory route either "on" or "under" the structure.
2. Roadway surface and shoulders - when there are no restrictions.

For a divided facility with a raised or non-mountable median, or an "under" route divided by piers, record the greater of the restricted widths in either direction, not both directions.

*The purpose of this item is to give the **largest available horizontal clearance for the movement of wide loads**. Code the largest of available clearance between restrictive features such as curbs, railings, sidewalks, wheel guards, raised medians and to the structural features limiting the roadway surface width from either cardinal or non-cardinal direction, measured perpendicular to the center line of roadway for the route identified in NBI Item #5. Raised Button-Type medians and small raised lane channeling curbs, etc. are not considered restrictions.*

*The term "Cardinal" refers to the "Primary" direction of the route on the bridge (direction in which the route is officially measured for a particular agency's records).*

*For culvert type structures, which appear on the route as a bridge but actually have no deck, the coded clearance should show the full width of the pavement plus shoulders except where this dimension is limited by guardrail, culvert end-walls, etc.*

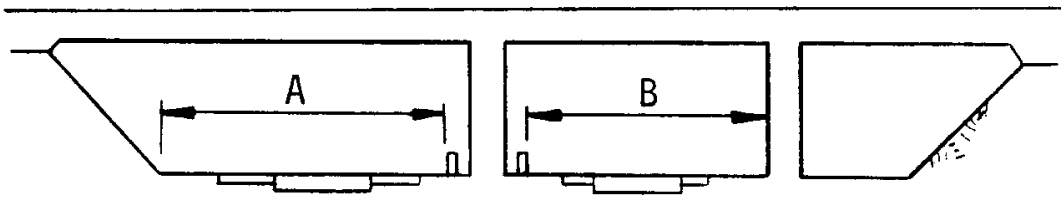

Clearance  $A > B$     Item 47 = A

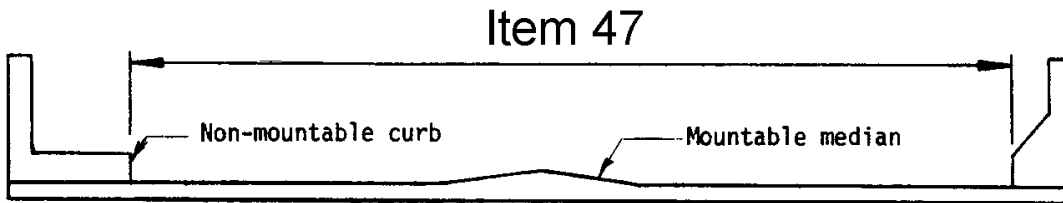

No Median or Flush or Mountable Median

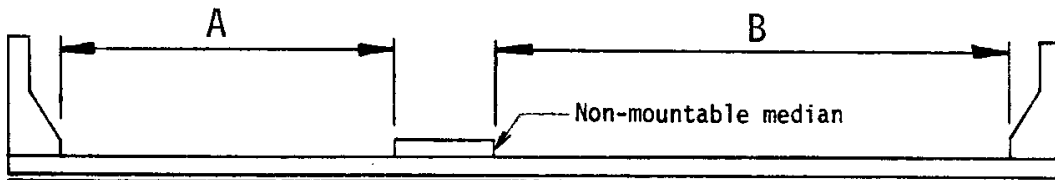

Raised Median or Non-mountable Median

$B > A$     Item 47 = B

# Ohio Bridge Inventory Guide

---

## **NBI #48 – Length of Maximum Span**

The length of the maximum span shall be recorded. It shall be noted whether the measurement is center to center of bearing points or clear open distance between piers, bents, or abutments. The measurement shall be along the centerline of the bridge.

*The length of the maximum (longest) span should be coded for this item. (This item is not for coding total length of all spans).*

*Examples:*

<b><u>Length of Maximum Span</u></b>	<b><u>Code</u></b>
50 Feet	50.000
117 Feet	117.000

## **NBI #49 – Structure Length**

Record and code the length of the structure to the nearest tenth of a *foot*. This shall be the length of roadway which is supported on the bridge structure. The length should be measured back to back of backwalls of abutments or from paving notch to paving notch.

Culvert lengths should be measured along the center line of roadway regardless of their depth below grade. Measurement should be made between inside faces of exterior walls.

*Code the total length of the structure (bridge or culvert) measured along the center line of the roadway, regardless of the skew angle. This length should be measured back to back of abutments or walls, between expansion joints at abutments or between paving notches. When taking the measurements from the plans, the Bridge Limits may be used.*



# Ohio Bridge Inventory Guide

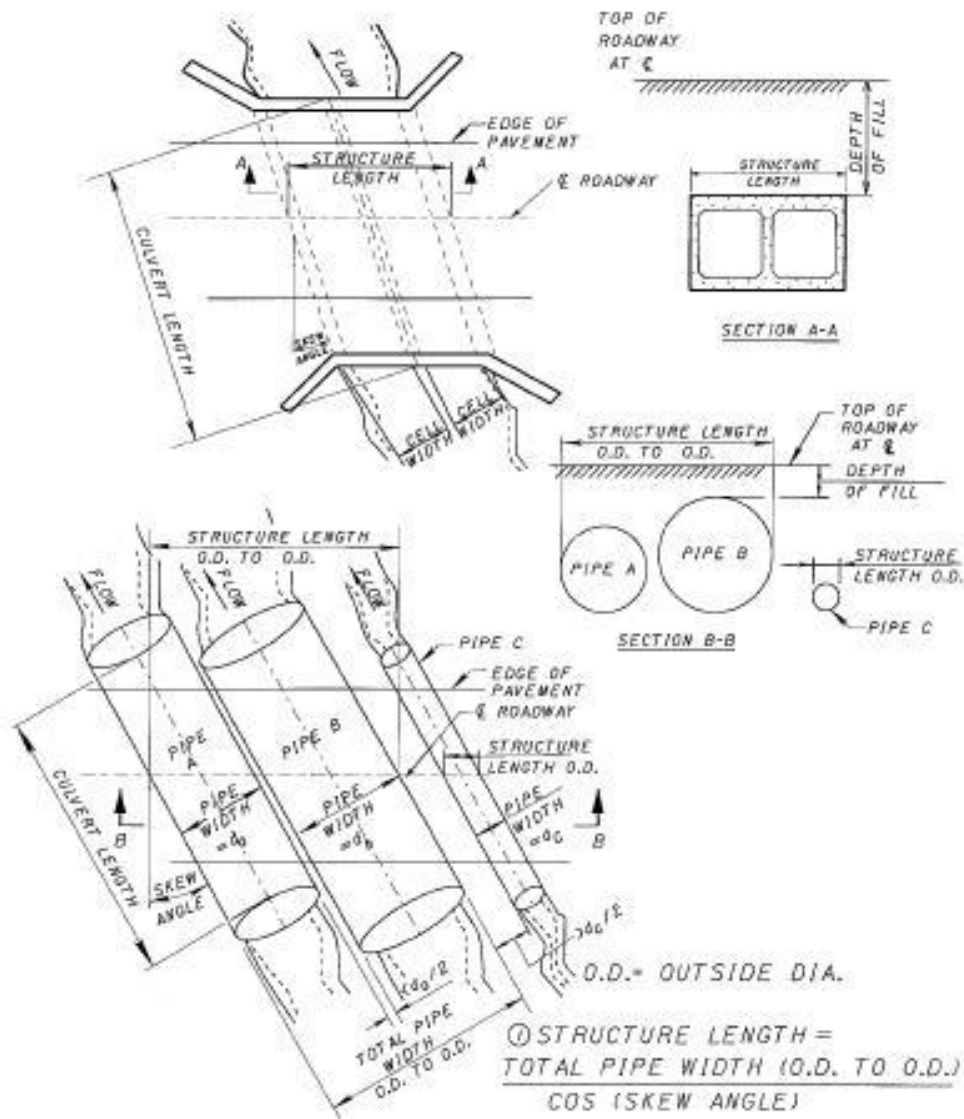

---

# Ohio Bridge Inventory Guide

---

## NBI #50A – Curb or Sidewalk Left Side – Width

Record and code to represent the width of the left curb or sidewalk. "Left" and "Right" should be determined on the basis of direction of the inventory of route.

*Code the width of the left curb or sidewalk. "Left" to be determined on the basis of the established cardinal direction of the route. Sidewalks are generally greater than two (2) feet (2') in width.*

## NBI #50B – Curb or Sidewalk Right Side - Width

Record and code to represent the width of the right curb or sidewalk. "Left" and "Right" should be determined on the basis of direction of the inventory of route.

*Code the width of the right curb or sidewalk. "Right" to be determined on the basis of the established cardinal direction of the route. Sidewalks are generally greater than two (2) feet (2') in width.*

## NBI #51 – Bridge Roadway Width, Curb-to-Curb

The information to be recorded is the most restrictive minimum distance between curbs or rails on the structure roadway. For structures with closed medians and usually for double decked structures, coded data will be the sum of the most restrictive minimum distances for all roadways carried by the structure\*. The data recorded for this item must be compatible with other related route and bridge data (i.e., Items 28, 29, 32, etc.). The measurement should be exclusive of flared areas for ramps.

Where traffic runs directly on the top slab (or wearing surface) of a culvert-type structure, e.g. an R/C box without fill, code the actual roadway width (curb-to-curb or rail-to-rail). This will also apply where the fill is minimal and headwalls or parapets affect the flow of traffic.

Where the roadway is on fill carried across a structure and the headwalls or parapets do not affect the flow of traffic, code 0000.

This is considered proper inasmuch as a filled section simply maintains the roadway cross-section. However, for sidehill viaduct structures code the actual full curb-to-curb roadway width.

\* Raised or non-mountable medians, open medians, and barrier widths are to be excluded from the summation along with barrier-protected bicycle and equestrian lanes.

*The information to be coded for this item is the distance between curbs or sidewalks or toe/toe of parapets on the structure.*

*This item must be coded for all highway bridges, except for culverts under fill. For culverts under fill, code all zeros. When traffic runs directly on the top slab (or minimum fill) of a frame (or a culvert coded as a frame), code the actual roadway width (curb to curb or rail to rail or parapet to parapet or between headwalls).*

*The measurement should be exclusive of flared areas for ramps: i.e., it should be the minimum or nominal width.*

# Ohio Bridge Inventory Guide

---

For structures carrying non-highway traffic (railroads, pedestrians, buildings, conveyers, etc.) and structures with no deck, code all 0000.

**This item must be equal to or less than NBI Item #52, Deck Width (Out/Out).**

## **NBI #52 – Deck Width (Out/Out)**

Record and code to show the out-to-out width. If the structure is a through structure, the number to be coded will represent the lateral clearance between superstructure members. The measurement should be exclusive of flared areas for ramps. Where traffic runs directly on the top slab (or wearing surface) of the culvert (e.g., an R/C box without fill) code the actual width (out-to-out). This will also apply where the fill is minimal and the culvert headwalls affect the flow of traffic. However, for sidehill viaduct structures code the actual out-to-out structure width. See figure below.

FIGURE ILLUSTRATING CODING  
OF SIDEHILL VIADUCTS

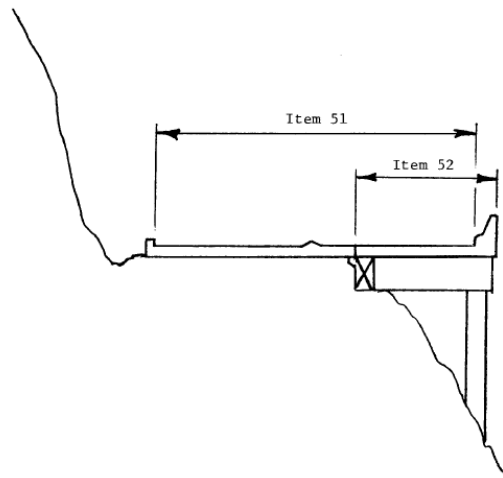

Where the roadway is on a fill carried across a pipe or box culvert and the culvert headwalls do not affect the flow of traffic, code 0000. This is considered proper inasmuch as a filled section over a culvert simply maintains the roadway cross-section.

*This item must be coded for all highway bridges. Code out-to-out width of the deck in feet. The measurement should be exclusive of flared areas for ramps i.e., it should represent the minimum deck width. This item must be coded either equal to or greater than NBI Item #51, Bridge Roadway Width, Curb-to-Curb.*

*For culverts under fill, code all zeros. Do not leave this item blank.*

# Ohio Bridge Inventory Guide

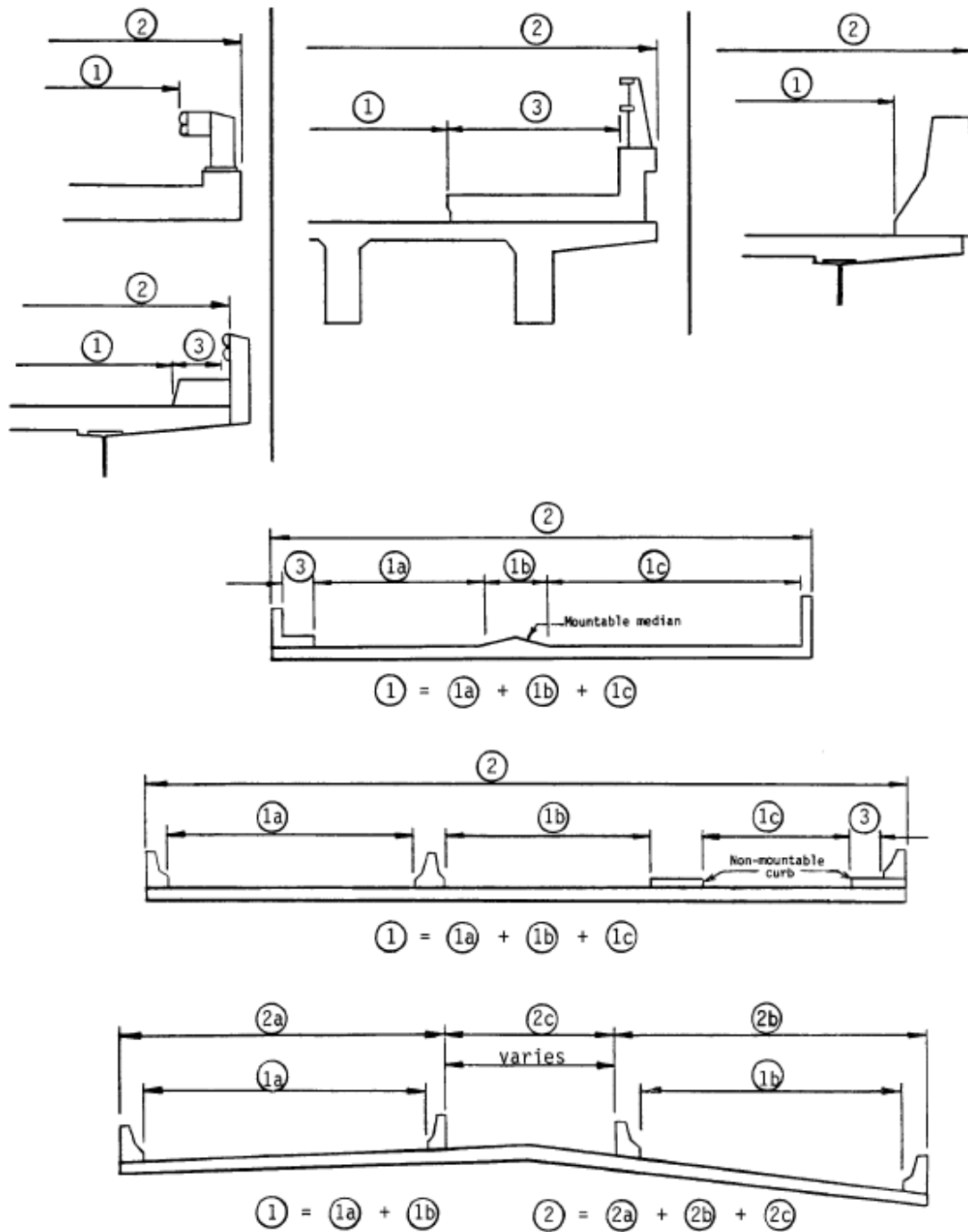

- 1) NBI Item #51 – Bridge Roadway Width, Curb-to-Curb
- 2) NBI Item #52 – Deck Width, Out-to-Out
- 3) NBI Item #50 – Curb or Sidewalk Width

# Ohio Bridge Inventory Guide

---

## NBI #53 – Minimum Vertical Clearance over Bridge Roadway

The information to be recorded for this item is the actual minimum vertical clearance over the bridge roadway, including shoulders, to any superstructure restriction. For double decked structures code the minimum, regardless whether it is pertaining to the top or bottom deck. When no superstructure restriction exists above the bridge roadway, or when a restriction is 100 feet or greater, code 99.99.

*Code minimum (lowest) vertical clearance on the bridge roadway to any superstructure restriction in any direction. If there are multiple openings, code the minimum clearance for all the openings. Code the entire item with zeros (00.00) for structures which do not carry a highway. When no superstructure restriction exists above bridge roadway code 99.999.*

***This item must be coded. Do not leave it blank.***

## NBI #54 – Minimum Vertical Underclearance

Code the reference feature from which the clearance measurement is taken and minimum vertical clearance from the roadway (travel lanes only) or railroad track beneath the structure to the underside of the superstructure. (When both a railroad and highway are under the structure, code the most critical dimension.)

Segment	Description	Length
54A	Reference feature	1 digit
54B	Minimum Vertical Underclearance	4 digits

Using one of the codes below, the reference feature from which the clearance measurement is taken:

Code	Description
H	Highway beneath structure
R	Railroad beneath structure
N	Feature not a highway or railroad

Code to represent the minimum vertical clearance from that feature to the structure. When a restriction is 100 feet or greater, code 99.99. If the feature is not a highway or railroad, code the minimum vertical clearance 0000.

*Code Minimum Vertical Clearance from the roadway or railroad track beneath the structure to the underside of the superstructure. For divided highways under a structure, code the minimum vertical clearance in either direction of travel (Cardinal and Non-Cardinal). Code the entire item with zeros for structures which are not over a highway or railroad (such as a waterway). When both highway and railway are beneath the structure, code the most critical dimension.*

# Ohio Bridge Inventory Guide

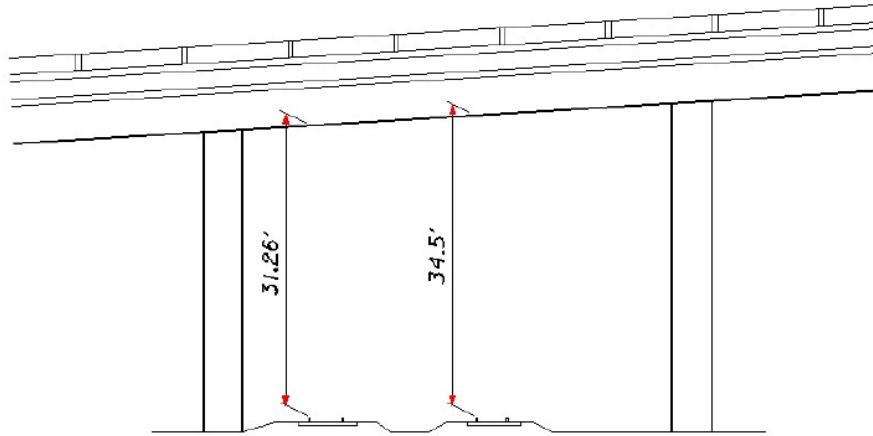

*Railroad 31.26' beneath structure*

## [NBI #55 - Minimum Lateral Underclearance on Right](#)

Code the reference feature under the bridge from which the clearance measurement is taken and the minimum lateral under clearance on the right. When both railroad and highway are under the structure, code the most critical dimension.

Using one of the codes below, code the reference feature from which the clearance measurement is taken:

Code	Description
H	Highway beneath structure
R	Railroad beneath structure
N	Feature not a highway or railroad

Code to represent the minimum lateral underclearance on the right. The lateral clearance should be measured from the right edge of the roadway (excluding shoulders) or from the centerline (between rails) of the right-hand track of a railroad to the nearest substructure unit (pier, abutment, etc.), to a rigid barrier (concrete bridge rail, etc.), or to the toe of slope steeper than 1 to 3, e.g. 1 to 1 or 2 to 1. The clearance measurements to be recorded will be the minimum after measuring the clearance in both directions of travel. In the case of a dual highway this would mean the outside clearances of both roadways should be measured and the smaller distance recorded and coded.

If two related features are below the bridge, measure both and record the lesser of the 2. An explanation should be written on the inspection form as to what was recorded. When the clearance is *100 feet* or greater, code 99.9.

# Ohio Bridge Inventory Guide

---

If the feature beneath the structure is not a railroad or highway, code 00.0. The presence of ramps and acceleration or turning lanes is not considered in this item; therefore, the minimum lateral clearance on the right should be measured from the right edge of the through roadway.

*Record and code the minimum lateral under clearance on the right, looking in the direction of traffic. When both a railroad and highway are under the structure, code the most critical dimension.*

*The lateral clearance should be measured from the right edge of the roadway (excluding shoulders) or from the centerline (between rails) of the right-hand track of a railroad to the nearest substructure unit (pier, abutment, etc.), to a rigid barrier (concrete bridge rail), or to the toe of the slope etc. steeper than 1 to 3. The clearance measurements to be recorded will be the **minimum after measuring** the clearance in **both directions of travel**. In the case of a dual highway under the bridge, this would mean the outside clearances of both roadways should be measured and the smaller distance recorded and coded.*

*If two (2) related features are below the bridge, measure both and record the lesser of the two. Code 99.999 when the clearance is more than 99 feet.*

*If the feature beneath the structure is not a railroad or highway, code all zeroes.*

*The presence of ramps and acceleration or turning lanes is not considered in this item; therefore, the minimum lateral clearance on the right should be measured from the right edge of the **through** roadway.*

## **NBI #56 - Minimum Lateral Underclearance Left**

Code the minimum lateral underclearance on the left (median side for divided highways) to the nearest tenth of a foot. The lateral clearance should be measured from the left edge of the roadway (excluding shoulders) to the nearest substructure unit, to a rigid barrier, or to the toe of slope steeper than 1 to 3. Refer to examples.

In the case of a dual highway, the median side clearances of both roadways should be measured and the smaller distance recorded and coded. If there is no obstruction in the median area, a notation of "open" should be recorded and 99.9 should be coded. For clearances greater than 99 feet, code 99.8. Code 00.0 to indicate not applicable.

# Ohio Bridge Inventory Guide

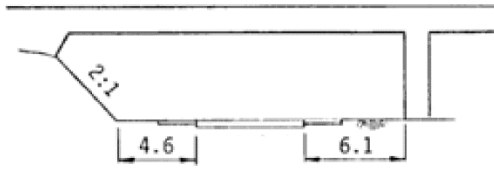

-- Lt. 4.6 Rt. for 2-way Traffic  
4.6 Lt. 6.1 Rt. for 1-way Traffic

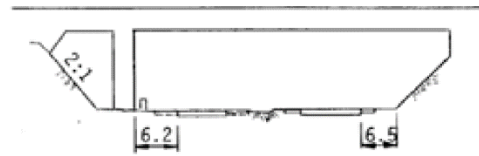

OPEN Lt. 6.2 Rt.

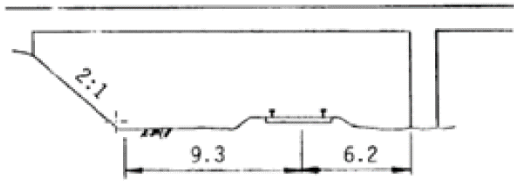

-- Lt. 6.2 Rt.

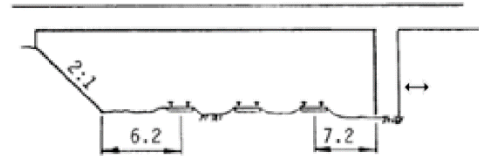

-- Lt. 6.2 Rt.

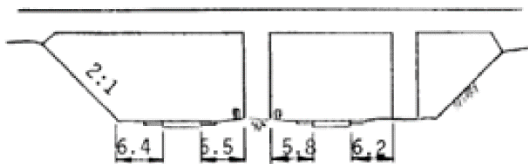

5.5 Lt. 6.2 Rt.

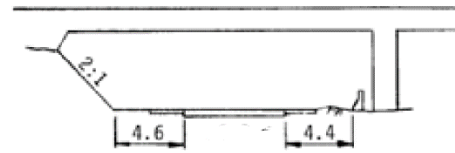

-- Lt. 4.4 Rt. for 2-way Traffic  
4.6 Lt. 4.4 Rt. for 1-way Traffic

Minimum Lateral Underclearances Examples  
Source: FHWA Bridge Inventory Coding Guide



# Ohio Bridge Inventory Guide

---

## NBI #57 - Reserved

Do not use it.

## NBI #58 through Item 62 – Indicate the Condition Ratings

Refer to the Manual of Ohio Bridge Inspection.

## NBI #63 – Method Used to Determine Operating Rating

Use one of the codes below to indicate which load rating method was used to determine the Operating Rating coded in Item 64 for this structure.

*This item will indicate the method of analysis for the load rating of the structure at operating level.*

*Code the appropriate description from the list below. While coding this item for bridges in Ohio, follow these guidelines:*

- (1) Do not use Codes 1, 2, 3 A, B, or C.
- (2) **When load rating calculations are performed, use Code 6 or 8, based on the method, and code RFs in NBI #64.**
- (3) When load rating is assigned based on the SS 940 or ASTM Specification, use Code D or F and code NBI Item #64 as RF.
- (4) **When using Code 0, 4 or 5, code NBI Item #64 in tons.**
- (5) Code 0 is to be used when the load rating is determined by field evaluation and documented engineering judgment, typically done when plans are not available or in case of severe deterioration. Field evaluation and engineering judgment ratings must be documented and kept in bridge file.
- (6) Code 5 is to be used temporarily, when the bridge has not been load-rated yet or load rating documentation does not exist. This code is generally used for new bridges, for which load rating calculations are still in the process. Eventually this code is to be changed as the calculations are completed.
- (7) If design plans are available but for some reasons, a bridge cannot be correctly analyzed to obtain rating factors (e.g., if a structure cannot be modeled using the rating tools available even though it is known that it has been designed, & built according to the prevailing Specifications and is as good as new), then Codes D or F can be used, accordingly.

<b>Code</b>	<b>Description</b>
0	Field evaluation and documented engineering judgment ( <b>Code Item #64 in tons</b> )
1	Load Factor (LF) reported in tons using HS20 loading
2	Allowable Stress (AS) reported in tons using HS20 loading
3	Load Resistance Factor Rating (LRFR) reported in tons using HS20 loading

## Ohio Bridge Inventory Guide

---

4	<b>Load Testing (Code Item 64 in tons)</b>
5	<b>No rating analysis or evaluation performed (Code Item 64 in tons)</b>
6	<b>Load Factor (LF) rating reported by rating factor (RF) using HS20 loading</b>
7	Allowable Stress (AS) rating reported by rating factor (RF) using HS20 loading
8	<b>Load and Resistance Factor Rating (LRFR) rating reported by rating factor (RF) using HL93 loading</b>
A	Assigned rating based on Load Factor Design (LFD) reported in tons using HS20 loading
B	Assigned ratings based on Allowable Stress (AS) reported in ton using HS20 loadings
C	Assigned ratings based on Load and Resistance Factor Rating (LRFR) reported in tons using HL93 loadings
D	Assigned rating based on Load Factor Rating (LF) reported by rating factor (RF) using HS20 loading
E	Assigned ratings based on Allowable Stress (AS) reported by rating factor (RF) using HS20 loading
F	Assigned ratings based on Load and Resistance Factor Rating (LRFR) reported by rating factor (RF) using HL93 loading

### NBI #64 - Operating Rating

This capacity rating, referred to as the operating rating, will result in the absolute maximum permissible load level to which the structure may be subjected for the vehicle type used in the rating.

It should be emphasized that only *HS* loading shall be used to determine the operating rating.

The AASHTO Manual for Condition Evaluation of Bridges provides a choice of load rating methods, such as the new load and resistance factor (LRFR) rating method, in addition to the traditional allowable stress (AS) and load factor (LF) methods. Of the three rating methods, the LF method is the most suitable for use as a national standard, therefore the FHWA has chosen the LF method as the standard for computing inventory and operating ratings reported to the NBI. The highway agencies may, however, elect to use LF, LRFD to establish load limits for purposes of load posting.

If the bridge will not carry a minimum of 3.0 tons of live load, the operating rating shall be coded '00.0'; and consistent with the direction of the AASHTO Manual, it shall be closed.

The use or presence of a temporary bridge requires special consideration in coding. In such cases, since there is no permanent bridge, Items 64 and 66 should be coded as 000 even though the temporary structure is rated for as much as full legal load.

A bridge shored up or repaired on a temporary basis is considered a temporary bridge and the inventory and operating rating shall be coded as if the temporary shoring were not in place. See NBI Item #103 – Temporary Structure Designation for definition of a temporary bridge.

Code 99.9 for a structure under sufficient fill such that, according to AASHTO design, the live load is insignificant in the structure load capacity.

# Ohio Bridge Inventory Guide

---

FHWA server records maximum value of the rating factor as 3.0, but irrespective of that the actual RF shall be coded.

When Item 63 is coded as "0", "4" or "5", NBI Item #64 must be coded in tons.

If a bridge is closed and/or will not carry any live load, the Rating Factor shall be coded as 0.0.

The use or presence of temporary bridge requires special consideration in coding. In such cases, since there is no permanent bridge, Rating Factor should be coded as 0.0.

A bridge shored up or repaired on a temporary basis is considered a temporary arrangement bridge and the Rating Factor should be coded as if the temporary shoring were not in place.

On new and other highway structures, if a load rating analysis has not been performed, the Operating Load Rating Factor may be coded as 1.250.

Note: Operating Rating (NBI Item #64) cannot be less than or equal to Inventory Rating (NBI Item #66.)

## Examples

Type of Bridge	Code
Temporary bridge	0.0
Shored-up bridge **	0.1
Structures under sufficient fill that live load on structure is insignificant	3.0

\*\*Rating Factor without shoring

## **NBI #65 – Method Used to Determine Inventory Rating**

Use one of the codes below to indicate which load rating method was used to determine the Inventory Rating coded in Item 66 for this structure.

This item will indicate the method of analysis for the load rating of the structure at inventory or design level.

Code the appropriate description from the list below. While coding this item for bridges in Ohio, follow these guidelines:

- (1) Do not use Codes 1, 2, 3 A, B, or C.
- (2) **When load rating calculations are performed, use Code 6 or 8, based on the method, and code RFs in NBI #66.**
- (3) When load rating is assigned based on the SS 940 or ASTM Specification, use Code D or F and code NBI Item #66 as RF.
- (4) **When using Code 0, 4 or 5, code NBI Item #66 in tons.**

# Ohio Bridge Inventory Guide

---

- (5) Code 0 is to be used when the load rating is determined by field evaluation and documented engineering judgment, typically done when plans are not available or in case of severe deterioration. Field evaluation and engineering judgment ratings must be documented and kept in bridge file.
- (6) Code 5 is to be used temporarily, when the bridge has not been load-rated yet or load rating documentation does not exist. This code is generally used for new bridges, for which load rating calculations are still in the process. Eventually this code is to be changed as the calculations are completed.
- (7) If design plans are available but for some reasons, a bridge cannot be correctly analyzed to obtain rating factors (e.g., if a structure cannot be modeled using the rating tools available even though it is known that it has been designed, & built according to the prevailing Specifications and is as good as new), then Codes D or F can be used, accordingly.

<u>Code</u>	<u>Description</u>
<b>0</b>	<b>Field evaluation and documented engineering judgment (Code Item #66 in tons)</b>
1	Load Factor (LF) reported in tons using HS20 loading
2	Allowable Stress (AS) reported in tons using HS20 loading
3	Load Resistance Factor Rating (LRFR) reported in tons using HS20 loading
<b>4</b>	<b>Load Testing (Code Item 64 in tons)</b>
<b>5</b>	<b>No rating analysis or evaluation performed (Code Item 64 in tons)</b>
<b>6</b>	<b>Load Factor (LF) rating reported by rating factor (RF) using HS20 loading</b>
7	Allowable Stress (AS) rating reported by rating factor (RF) using HS20 loading
<b>8</b>	<b>Load and Resistance Factor Rating (LRFR) rating reported by rating factor (RF) using HL93 loading</b>
A	Assigned rating based on Load Factor Design (LFD) reported in tons using HS20 loading
B	Assigned ratings based on Allowable Stress (AS) reported in ton using HS20 loadings
C	Assigned ratings based on Load and Resistance Factor Rating (LRFR) reported in tons using HL93 loadings
D	Assigned rating based on Load Factor Rating (LF) reported by rating factor (RF) using HS20 loading
E	Assigned ratings based on Allowable Stress (AS) reported by rating factor (RF) using HS20 loading
F	Assigned ratings based on Load and Resistance Factor Rating (LRFR) reported by rating factor (RF) using HL93 loading

## NBI #66 - Inventory Rating

This capacity rating, referred to as the inventory rating, will result in a load level which can safely utilize an existing structure for an indefinite period of time. Only HS loading shall be used to determine the

Code 99.9 for a structure under sufficient fill such that, according to AASHTO design, the live load is insignificant in the structure load capacity.

# Ohio Bridge Inventory Guide

---

FHWA server records maximum value of the rating factor as 3.0, but irrespective of that the actual RF shall be coded.

When Item 65 is coded as "0", "4" or "5", NBI Item #66 must be coded in tons.

If a bridge is closed and/or will not carry any live load, the Rating Factor shall be coded as 0.0.

The use or presence of temporary bridge requires special consideration in coding. In such cases, since there is no permanent bridge, Rating Factor should be coded as 0.0.

A bridge shored up or repaired on a temporary basis is considered a temporary arrangement bridge and the Rating Factor should be coded as if the temporary shoring were not in place.

On new and other highway structures, if a load rating analysis has not been performed, the inventory Load Rating Factor may be coded as 1.0.

Note: Operating Rating (NBI Item #64) cannot be less than or equal to Inventory Rating (NBI Item #66.)

## Examples

Type of Bridge	Code
Temporary bridge	0.0
Shored-up bridge **	0.1
Structures under sufficient fill that live load on structure is insignificant	3.0

\*\*Rating Factor without shoring

## [NBI #s 67, 68, 69 – Refer to FHWA Coding Guide](#)

Refer to FHWA Bridge Inventory and Appraisal Coding Guide for explanation.

Items 67, 68, 69, 71, and 72 - Indicate the Appraisal Ratings The items in the Appraisal Section are used to evaluate a bridge in relation to the level of service which it provides on the highway system of which it is a part. The structure will be compared to a new one which is built to current standards for that particular type of road as further defined in this section except for Item 72 - Approach Roadway Alignment. See Item 72 for special criteria for rating that item.

Items 67, 68, 69, 71, and 72 will be coded with a 1-digit code that indicates the appraisal rating for the item. The ratings and codes are as follows:

Code	Description
N	Not applicable
9	Superior to present desirable criteria
8	Equal to present desirable criteria
7	Better than present minimum criteria

# Ohio Bridge Inventory Guide

---

6	Equal to present minimum criteria
5	Somewhat better than minimum adequacy to tolerate being left in place as is
4	Meets minimum tolerable limits to be left in place as is
3	Basically intolerable requiring high priority of corrective action
2	Basically intolerable requiring high priority of replacement
1	This value of rating code not used
0	Bridge closed

The FHWA computer program calculates values for Items 67, 68 and 69 according to the tables provided in the manual. These tables and the table for Item 71 shall be used by all evaluators to rate these items. They have been developed to closely match the descriptions for the appraisal evaluation codes of 0 to 9. The tables shall be used in all instances to evaluate the item based on the designated data in the inventory, even if a table value does not appear to match the descriptive codes. For unusual cases where the site data does not exactly agree with the table criteria, use the most appropriate table to evaluate the item. The code of N is not valid for use with Items 67 and 72.

Completed bridges not yet opened to traffic, if rated, shall be appraised as if open to traffic. Design values, for example ADT, shall be used for the evaluation. The data provided will include a code of G for Item 41 - Structure Open, Posted, or Closed to Traffic.

*Do not code NBI Items #67, #68, and #69, as they are calculated internally by the System*

## **NBI #70 - Bridge Posting**

The National Bridge Inspection Standards require the posting of load limits only if the maximum legal load configurations in the State exceed the load permitted under the operating rating. If the load capacity at the operating rating is such that posting is required, this item shall be coded 4 or less. If no posting is required at the operating rating, this item shall be coded 5.

This item evaluates the load capacity of a bridge in comparison to the State legal load. It differs from Item #67 - Structural Evaluation in that Item #67 uses Item #66 – Inventory Rating, while the bridge posting requirement is based on Item #64 – Operating Rating.

Although posting a bridge for load-carrying capacity is required only when the maximum legal load exceeds the operating rating, highway agencies may choose to post at a lower level. This posting practice may appear to produce conflicting coding when Item #41 – Structure Open, Posted or Closed to Traffic is coded to show the bridge as actually posted at the site and Item #70 – Bridge Posting is coded as bridge posting is not required. Since different criteria are used for coding these 2 items, this coding is acceptable and correct when the highway agency elects to post at less than the operating rating. Item #70 shall be coded 4 or less only if the legal load of the State exceeds that permitted under the operating rating.

## Ohio Bridge Inventory Guide

---

The use or presence of a temporary bridge affects the coding. The actual operating rating of the temporary bridge should be used to determine this item. However, the highway agency may choose to post at a lower level. This also applies to bridges shored up or repaired on a temporary basis.

<u>Code</u>	<u>Description</u>
4 or less	Posting required
5	No posting required

The degree that the operating rating is less than the maximum legal load level may be used to differentiate between codes. As a guide and for coding purposed only, the following values may be used to code this item:

<u>Code</u>	<u>Relationship of Operating Rating to Maximum Legal Load</u>
5	Equal to or above legal loads
4	0.1 - 9.9% below
3	10.0 – 19.9% below
2	20.0 – 29.9% below
1	30.0 – 39.9% below
0	>39.9% below

**Procedures for Posting Load Restrictions on ODOT Bridges:** Bridges shall be posted for weight restriction when, after rounding, the rating factor for anyone (1) of the Ohio Legal Vehicles drops below 100% (or when the actual Rating Factor (RF) is less than 95.7%).

**Bridges that are not capable of carrying 3-Tons GVW, for any truck, shall be closed to all traffic.**

### **Ohio Legal Vehicles**

<b>Vehicle</b>	<b>Description</b>	<b>Gross Vehicle Weight (GVW)</b>
2F1	2 Axle truck	15T
3F1	3 Axle truck	23T
4F1	4 Axle truck	27T
5C1	5 Axle truck	40T

<b>SHV</b>	<b>Description</b>	<b>Gross Vehicle Weight (GVW)</b>
SU4	4 Axle Special Hauling Vehicle	27 T
SU5	5 Axle Special Hauling Vehicle	31 T
SU6	6 Axle Special Hauling Vehicle	34.75 T
SU7	7 Axle Special Hauling Vehicle	38.75 T

<b>Emergency Vehicles</b>	<b>Description</b>	<b>Gross Vehicle Weight (GVW)</b>
---------------------------	--------------------	-----------------------------------

# Ohio Bridge Inventory Guide

<i>EV2</i>	<i>2 Axle Emergency Vehicles</i>	<i>28.75 T</i>
<i>EV3</i>	<i>3 Axle Emergency Vehicles</i>	<i>43 T</i>

## NBI #71 - Waterway Adequacy

This item appraises the waterway opening with respect to passage of flow through the bridge. The following codes shall be used in evaluating waterway adequacy. Site conditions may warrant somewhat higher or lower ratings than indicated by the table (e.g., flooding of an urban area due to a restricted bridge opening).

Where overtopping frequency information is available, the descriptions given in the table for chance of overtopping mean the following:

<b><u>Remote</u></b>	Greater than 100 years
<b><u>Slight</u></b>	11 to 100 years
<b><u>Occasional</u></b>	3 to 10 years
<b><u>Frequent</u></b>	Less than 3 years

Adjectives describing traffic delays mean the following:

<b><u>Insignificant</u></b>	Minor inconvenience. Highway passable in a matter of hours.
<b><u>Significant</u></b>	Traffic delays of up to several days.
<b><u>Severe</u></b>	Long term delays to traffic with resulting hardship.

Functional Classification			Description
Principal Arterials – Interstates, Freeways or Expressways	Other Principal and Minor Arterials and Major Collectors	Minor Collectors, Locals	
N	N	N	Bridge not over a waterway.
9	9	9	Bridge deck and roadway approaches above flood water elevations (high water). Chance of overtopping is remote.
8	8	8	Bridge deck above roadway approaches. Slight chance of overtopping roadway approaches.
6	6	7	Slight chance of overtopping bridge deck and roadway approaches.
4	5	6	Bridge deck above roadway approaches. Occasional overtopping of roadway approaches with insignificant traffic delays.



## Ohio Bridge Inventory Guide

---

3	4	5	Bridge deck above roadway approaches. Occasional overtopping of roadway approaches with significant traffic delays.
2	3	4	Occasional overtopping of bridge deck and roadway approaches with significant traffic delays.
2	2	3	Frequent overtopping of bridge deck and roadway approaches with significant traffic delays.
2	2	2	Occasional or frequent overtopping of bridge deck and roadway approaches with severe traffic delays.
0	0	0	Bridge closed.

### **NBI #72 - Approach Roadway Alignment**

Code the rating based on the adequacy of the approach roadway alignment. This item identifies those bridges which do not function properly or adequately due to the alignment of the approaches. It is not intended that the approach roadway alignment be compared to current standards but rather to the existing highway alignment. This concept differs from other appraisal evaluations. The establishment of set criteria to be used at all bridge sites is not appropriate for this item. The basic criteria is how the alignment of the roadway approaches to the bridge relate to the general highway alignment for the section of highway the bridge is on.

The individual structure shall be rated in accordance with the general appraisal rating guide described on page 453 in lieu of specific design values. The approach roadway alignment will be rated intolerable (a code of 3 or less) only if the horizontal or vertical curvature requires a substantial reduction in the vehicle operating speed from that on the highway section. A very minor speed reduction will be rated a 6, and when a speed reduction is not required, the appraisal code will be an 8. Additional codes may be selected between these general values.

For example, if the highway section requires a substantial speed reduction due to vertical or horizontal alignment, and the roadway approach to the bridge requires only a very minor additional speed reduction at the bridge, the appropriate code would be a 6. This concept shall be used at each bridge site.

Speed reductions necessary because of structure width and not alignment shall not be considered in evaluating this item.

*Record the appropriate code from the table below about the condition of the approach alignment.*

*For example, if the highway section requires substantial speed reduction due to vertical or horizontal alignment, and roadway approach to the bridge requires only a very minor additional speed reduction at the bridge, the appropriate code would be 6. This concept shall be used at each bridge site.*

*Speed reductions necessary because of structure width and not alignment shall not be considered in evaluating this item.*

## Ohio Bridge Inventory Guide

---

<b><u>Code</u></b>	<b><u>Description</u></b>
<i>N</i>	<i>Not Applicable (for only Non-highway bridges)</i>
<i>9</i>	<i>Superior to present desirable criteria</i>
<i>8</i>	<i>Equal to present desirable criteria</i>
<i>7</i>	<i>Better than present minimum criteria</i>
<i>6</i>	<i>Equal to present minimum criteria</i>
<i>5</i>	<i>Somewhat better than minimum adequacy to tolerate being left in place as is</i>
<i>4</i>	<i>Meets minimum tolerable limits to be left in place as is</i>
<i>3</i>	<i>Basically intolerable requiring high priority of corrective action</i>
<i>2</i>	<i>Basically intolerable requiring high priority of replacement</i>
<i>0</i>	<i>Bridge Closed</i>

### **NBI #73 and NBI #74 - Reserved**

*Do not use.*

# Ohio Bridge Inventory Guide

---

## NBI #75 - Type of Work

The information to be coded for this item will be the type of work proposed to be accomplished on the structure to improve it to the point that it will provide the type of service needed and whether the proposed work is to be done by contract or force account.

Item #	Description
75A	Type of Work Proposed
75B	Work Done by

Use one of the following codes to represent the proposed work type. Otherwise, leave blank.

Code	Description
31	Replacement of bridge or other structure because of substandard carrying capacity or substandard bridge roadway geometry.
32	Replacement of bridge or other structure because of relocation of road.
33	Widening of existing bridge or other major structure without deck rehabilitation or replacement; includes culvert lengthening.
34	Widening of existing bridge with deck rehabilitation or replacement.
35	Bridge rehabilitation because of general structure deterioration or inadequate strength.
36	Bridge deck rehabilitation with only incidental widening.
37	Bridge deck replacement with only incidental widening.
38	Other structural work, including hydraulic replacements.

If Item #75A is blank, leave Item #75B blank. Otherwise, the third digit shall be coded using one of the following codes to indicate whether the proposed work is to be done by contract or by force account:

Code	Description
1	Work to be done by contract
2	Work to be done by owner's forces

### **Examples:**

	<u>Proposed Work Code</u>	<u>Work Done By</u>
A bridge is to be replaced by contract because it has deteriorated to the point that it can no longer carry legal loads. The same code should be used if the bridge is replaced because it is now too narrow or the original design was too light to accommodate today's legal loads.	31	1
A bridge is to be replaced because the roadway must be straightened to eliminate a dangerous curve. The work will be done by contract.	32	1

## Ohio Bridge Inventory Guide

---

A bridge deck is to be rehabilitated by contract and a safety curb to be removed which results in incidental widening of 2 feet.	36	1
A bridge deck is to be replaced by contract and the deck cantilever overhang extended 2 feet, which is the maximum that can be done without adding another line of stringers or girders to the superstructure.	37	1
A bridge which is no longer needed is to be demolished and an at-grade crossing built by State forces. (This code could also be used to designate incidental safety work on a bridge such as bridge-rail upgrading or replacement.)	38	2

*If Item #75A is blank, leave Item #75B blank.*

### **NBI #76 - Length of Structure Improvement**

Code the length of the bridge portion only of the proposed improvement. For replacement or rehabilitation of the entire bridge, the length should be back to back of backwalls of abutments or from pavement notch to pavement notch. For replacement or rehabilitation of only part of the structure, use the length of the portion to be improved.

For culvert improvements, use the proposed length measured along the centerline of the barrel regardless of the depth below grade. The measurement should be made between the inside faces of the top parapet or edge-stiffening beam of the top slab.

For substructure or channel work only, code the length of superstructure over, or supported by, the substructure or channel.

Typically, a replacement bridge is longer than the existing bridge. Nationwide averages for the increase in bridge length with replacement as a function of the existing length are given in the following figures. The length-expansion factors represent data for the years 1981 to 1985. Where site-specific data is lacking, these factors are suggested for estimating the length of replacement bridges. For exceedingly long bridges (i.e., 1000 feet or more) the length-expansion factor approaches 1.0.

# Ohio Bridge Inventory Guide

---

## INCREASED LENGTH OF REPLACED BRIDGES

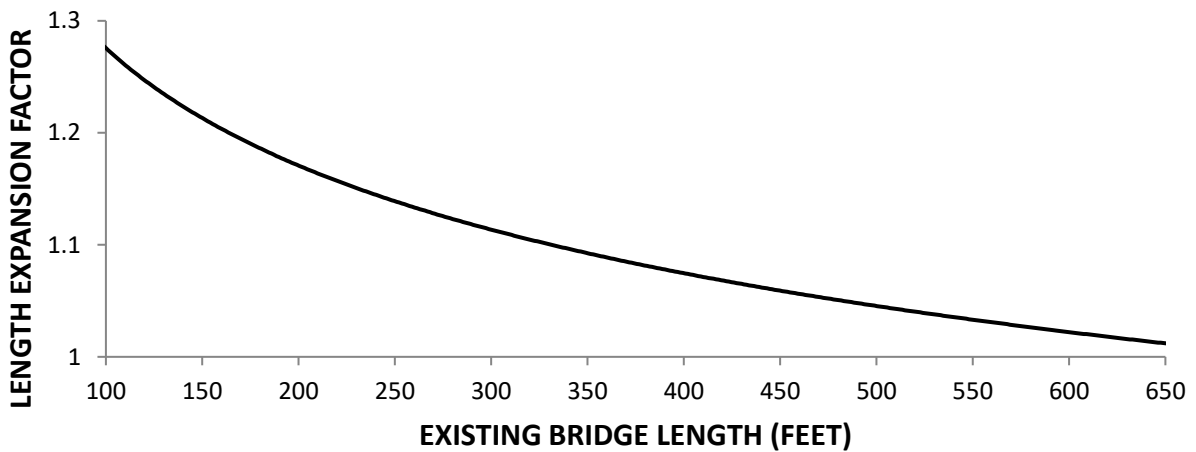
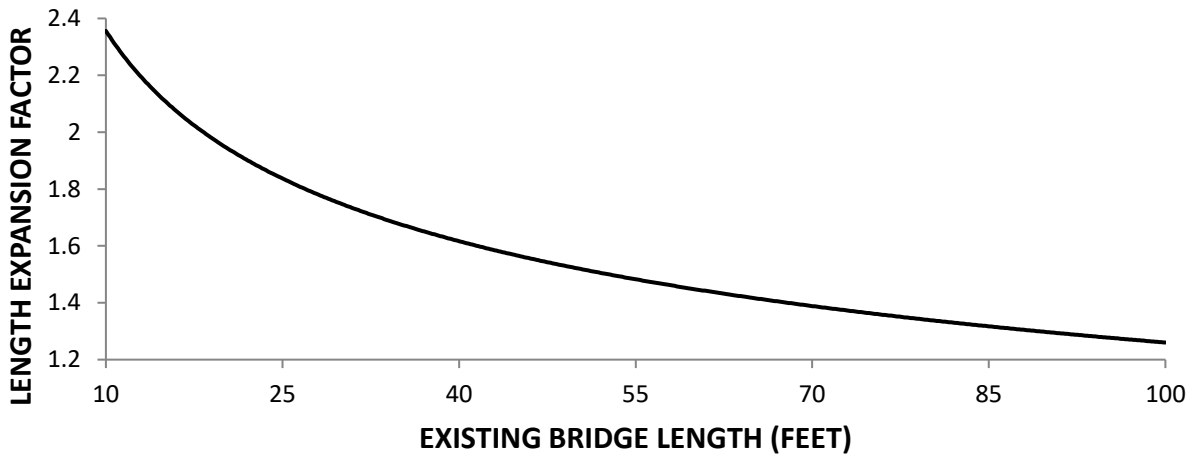

**REPLACEMENT BRIDGE LENGTH = EXISTING BRIDGE LENGTH X LENGTH EXPANSION FACTOR**

### [NBI #77 through NBI #89](#)

(Reserved)

*Do not use.*

# Ohio Bridge Inventory Guide

---

## NBI #90 – Inspection Date

*This is the routine inspection date of the most current bridge inspection.*

*For more details, refer to the Bridge Inspection Manual.*

## NBI #91, through #93

*For more details, refer to the Bridge Inspection Manual.*

## NBI #94 – Bridge Improvement Cost

Code the estimated cost of the proposed bridge or major structure improvements in thousands of dollars. This cost shall include only bridge construction costs, excluding roadway, right of way, detour demolition, preliminary engineering, etc. Do not use this item for estimating maintenance costs.

### Examples

<b>Bridge Improvement Cost</b>	<b>Code</b>
\$55,850	56
\$250,000	250
\$7,451,233	7451

Nationally, the deck area of replaced bridges is averaging 2.2 times the deck area before replacement. The deck area of rehabilitated bridges is averaging 1.5 times the deck area before rehabilitation. Widening square *feet* costs are typically 1.8 times the square *feet* cost of new bridges with similar spans.

Each highway agency is encouraged to use its best available information and established procedures to determine bridge improvement costs. In the absence of these procedures, the highway agency may wish to use the following procedure as a guide in preparing bridge improvement cost estimates.

Apply a construction unit cost to the proposed bridge area developed by using (1) current State deck geometry design standards and (2) proposed bridge length from Item #76 – Length of Structure Improvement.

## NBI #95 – Roadway Improvement Cost

Code the cost of the proposed roadway improvement in thousands of dollars. This shall include only roadway construction costs, excluding bridge, right-of-way, detour, extensive roadway realignment costs, preliminary engineering, etc. Do not use this item for estimating maintenance costs.

In the absence of a procedure for estimating roadway improvement costs, a guide of 10 percent of the bridge costs is suggested.

# Ohio Bridge Inventory Guide

---

## NBI #96 - Total Project Cost

Code the total project cost in thousands of dollars, including incidental costs not included in Items 94 and 95. This item should include all costs normally associated with the proposed bridge improvement project. The Total Project Cost will therefore usually be greater than the sum of Items NBI #94 and NBI #95. Do not use this item for coding maintenance costs.

## NBI #97 - Year of Improvement Cost Estimate

Record and code the year that the costs of work estimated in Item #94 – Bridge Improvements Cost, Item #95 – Roadway Improvement Cost, and Item 96 – Total Project Cost were based upon. This date and the data provided for Item 94 through Item 96 must be current; that is, Item #97 shall be no more than 8 years old.

## NBI #98 - Border Bridge

Use this item to indicate structures crossing borders of States. Code 2 segments specifying the percent responsibility for improvements to the existing structure when it is on a border with a neighboring State. Code first the neighboring State code using State codes listed in Item #1 - State Code.

Code the percentage of total deck area of the existing bridge that the neighboring State is responsible for funding.

<b>Segment</b>	<b>Description</b>
98A	Neighboring State Code
98B	Percent Responsibility

If a neighboring State codes the structure and accepts 100% of the responsibility, but your State still codes a record for the structure, then Item #98B in your State's record should be coded 99 to represent that your State has no responsibility for the structure.

If structure is not on a border, leave all blank.

*From the drop down menu select a 3-digit number specifying the neighboring State using State Codes listed in Item 1 – State Code.*

*If structure is not on the border with adjacent state, leave blank.*

<b><u>State</u></b>	<b><u>Code</u></b>
<i>Indiana</i>	<i>185</i>
<i>Kentucky</i>	<i>214</i>
<i>Michigan</i>	<i>265</i>
<i>Pennsylvania</i>	<i>423</i>
<i>West Virginia</i>	<i>543</i>

# Ohio Bridge Inventory Guide

---

Examples:

<u>2 Explanations</u>	<u>Code</u>
A structure connects Ohio with a border state responsible for funding 45 percent of future improvement costs.	45
A structure connects Ohio with a border state responsible for funding 100 percent of future improvement costs.	99

## **NBI #99 – Border Bridge Structure Number**

Code the neighboring State’s National Bridge Inventory structure number for any structure noted in Item #98 – Border Bridges. This number must match exactly the neighboring State’s submitted NBI structure number.

***If Item #98A and Items #98B are blank, this item must be blank.***

## **NBI #100 – STRAHNET Highway Designation**

This item shall be coded for all records in the inventory. For the purposes of this item, the STRAHNET Connectors are considered included in the term STRAHNET. For the inventory route identified in NBI Item #5, indicate STRAHNET highway conditions using one (1) of the following codes:

<u>Code</u>	<u>Description</u>
0	The inventory route is not a STRAHNET route.
1	The inventory route is on an Interstate STRAHNET route.
2	The inventory route is on a Non-Interstate STRAHNET route.
3	The inventory route is on a STRAHNET connector route.

*All counties and municipalities shall code this item 0, unless their route is a STRAHNET route.*

*Maps of Ohio can be found at the link below:*

[https://www.fhwa.dot.gov/Planning/national\\_highway\\_system/](https://www.fhwa.dot.gov/Planning/national_highway_system/)

[http://www.fhwa.dot.gov/planning/national\\_highway\\_system/nhs\\_maps/ohio/index.cfm](http://www.fhwa.dot.gov/planning/national_highway_system/nhs_maps/ohio/index.cfm)

## **NBI #101 – Parallel Highway Designation**

Code this item to indicate situations where separate structures carry the inventory route in opposite directions of travel over the same feature. The lateral distance between structures has no bearing on the coding of this item. One of the following codes shall be used:



# Ohio Bridge Inventory Guide

<u>Code</u>	<u>Description</u>
R	The right structure of parallel bridges carrying the roadway in the direction of the inventory. (For a STRAHNET highway, this is west to east and south to north.)
L	The left structure of parallel bridges. This structure carries traffic in the opposite direction.
N	No parallel structure exists.

If the route is under a railroad, pipeline, etc. or there is no parallel structure, code N.

Structure #1 **Right (CARDINAL)**

Structure #2 **Left (NON-CARDINAL)**

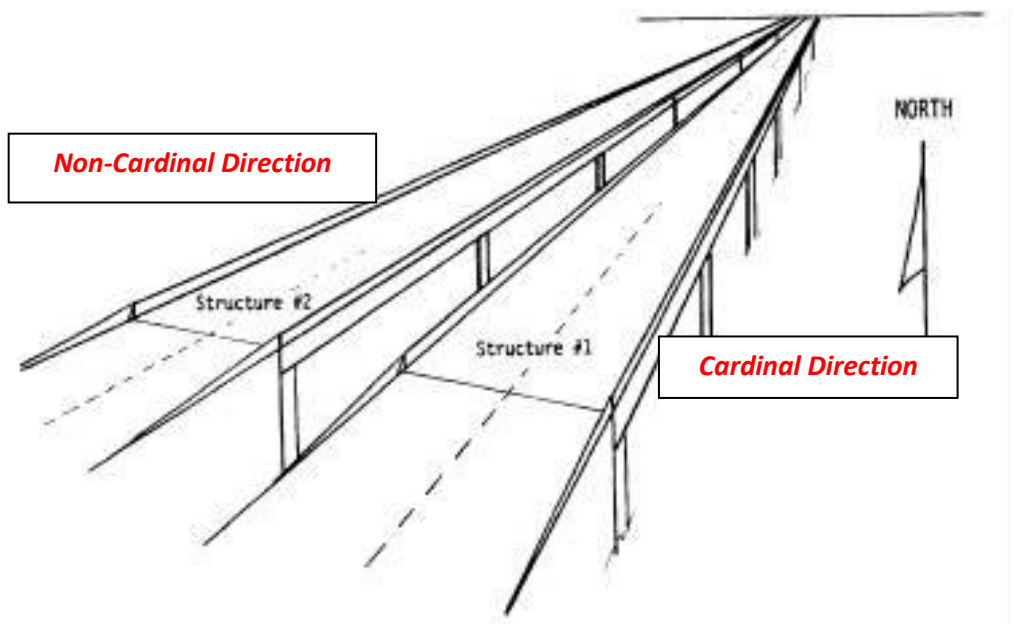

## **NBI #102 – Direction of Traffic**

Code the direction of traffic of the inventory route identified in NBI Item #5 using one of the codes below. This item must be compatible with other traffic-related items such as NBI Item #28A Lanes on the Structure, NBI Item #29 – Average Daily Traffic, NBI Item #47 – Total Horizontal Clearance and NBI Item #51 – Bridge Roadway Width, Curb-to-Curb.

<u>Code</u>	<u>Description</u>
0	Highway traffic not carried
1	1-way traffic
2	2-way traffic
3	One lane bridge for 2-way traffic

# Ohio Bridge Inventory Guide

---

## NBI #103 – Temporary Structure Designation

Code this item to indicate situations where temporary structures or conditions exist. This item should be blank if not applicable.

<u>Code</u>	<u>Description</u>
T	Temporary structure or conditions exist
Leave Blank	Not Applicable

Temporary structure(s) or conditions are those which are required to facilitate traffic flow. This may occur either before or during the modification or replacement of a structure found to be deficient. Such conditions include the following:

1. Bridge shored up, including additional temporary supports.
2. Temporary repairs made to keep a bridge open.
3. Temporary structures, temporary runarounds or bypasses.
4. Other temporary measures, such as barricaded traffic lanes to keep the bridge open.

Any repaired structure or replacement structure, which is expected to remain in place without further project activity other than maintenance, for a significant period of time, shall not be considered temporary. Under such conditions, that structure regardless of its type shall be considered the minimum adequate to remain in place and be evaluated accordingly.

If this item is coded T, then all data recorded for the structure shall be for the condition of the structure without temporary measures, except for the following items which shall be for the temporary structure:

<u>NBI Item</u>	<u>Description</u>
10	Inventory Route, Minimum Vertical Clearance
41	Structure Open, Posted, or Closed to Traffic
47	Inventory Route, Total Horizontal Clearance
53	Minimum Vertical Clearance Over Bridge Roadway
54	Minimum Vertical Underclearance
55	Minimum Lateral Underclearance on Right
56	Minimum Lateral Underclearance on Left
70	Bridge Posting

## NBI #104 – Highway System of the Inventory Route

This item is to be coded for all records in the inventory. For the inventory route identified in NBI Item #5, indicate whether the Inventory route is on the National Highway System (NHS) or not on that system.

Use one (1) of the following codes:

# Ohio Bridge Inventory Guide

---

<u>Code</u>	<u>Description</u>
0	Inventory Route <u>is not</u> on the NHS
1	Inventory Item <u>is</u> on the NHS

MAP-21 has broadened the definition of the National Highway System. It is referred to as the “Enhanced” NHS and it included intermodal connectors and principal arterials. All bridges on the Enhanced NHS will need to be inspected using Element Level inspection beginning in 2014. The deadline to make the conversion to Element Level inspection for these bridges was October 1, 2015.

For maps of NHS routes, refer to the following website below:

[http://www.fhwa.dot.gov/planning/national\\_highway\\_system/nhs\\_maps/ohio/index.cfm](http://www.fhwa.dot.gov/planning/national_highway_system/nhs_maps/ohio/index.cfm)

## NBI #105 – Federal Lands Highways

Structures owned by State and local jurisdictions on roads which lead to and traverse through federal lands sometimes require special coded unique identification because they are eligible to receive funding from the Federal Lands Highway Program. One (1) of the following codes shall be used:

<u>Code</u>	<u>Description</u>
0	Not Applicable
1	Indian Reservation Road (IRR)
2	Forest Highway (FH)
3	Land Management Highway System (LMHS)
4	Both IRR and FH
5	Both IRR and LMHS
6	Both FH and LMHS
9	Combined IRR, FH and LMHS

## NBI #106 – Year Reconstructed

Code the year when most recent reconstruction of the structure was completed. If there has been no reconstruction code 0000.

For a bridge to be defined as reconstructed, the type of work performed, whether or not it meets current minimum standards, must have been eligible for funding under any of the Federal-aid funding categories. The eligibility criteria would apply to the work performed regardless of whether all State or local funds or Federal-aid funds were used.

Some types of eligible work not to be considered as reconstruction are listed:

- Safety feature replacement or upgrading (for example, bridge rail, approach guardrail or impact attenuators).
- Painting of structural steel.

# Ohio Bridge Inventory Guide

---

- Overlay of bridge deck as part of a larger highway surfacing project (for example, overlay carried across bridge deck for surface uniformity without additional bridge work).
- Utility work.
- Emergency repair to restore structural integrity to the previous status following an accident.
- Retrofitting to correct a deficiency which does not substantially alter physical geometry or increase the load carrying capacity.
- Work performed to keep a bridge operational while plans for complete rehabilitation or replacement are under preparation (for example, adding a substructure element or extra girder).

***NBI Item #106-Year Reconstruction can never be equal to or less than the NBI Item #27 - Year Built.***

## **NBI #107 – Deck Structure Type**

Record the type of deck system on the bridge. If more than one type of deck system is on the bridge, code the most predominant. Code N for a filled culvert or arch with the approach roadway section carried across the structure. Use one of the following codes:

<b>Code</b>	<b>Description</b>
1	Concrete Cast-in-Place
2	Concrete Precast Panels
3	Open Grating
4	Closed Grating
5	Steel plate (includes orthotropic)
6	Corrugated steel
7	Aluminum
8	Wood or Timber
9	Other
N	Not applicable

*Where no deck or floor slab exists, such as for culverts, code item as N. When more than one (1) type of floor slab exists over the full length of the bridge, code the item for the predominate type. If a predominate type cannot be determined, code N.*

*A Jack Arch is defined as a deck support system comprised of a brick or concrete arch springing from the bottom flanges of adjacent rolled steel beams. There is not a Structure Type for Jack arches because the jack arch is actually a description of the deck, and this bridge is a special kind of steel beam bridge. Therefore you should code the structure type as a steel beam.*

## **NBI #108– Wearing Surface/Protection System**

Information on the wearing surface and protective system of the bridge deck shall be coded composed of 3 segments

# Ohio Bridge Inventory Guide

---

<u>Segment</u>	<u>Description</u>
108A	Type of Wearing Surface
108B	Type of Membrane
108C	Deck Protection

## #108A – Type of Wearing Surface

<u>Code</u>	<u>Description</u>
1	Monolithic Concrete (concurrently placed with structural deck)
2	Integral Concrete (separate non-modified layer of concrete added to structural deck)
3	Latex Concrete or similar additive
4	Low Slump Concrete
5	Epoxy Overlay
6	Bituminous
7	Wood or Timber – Not an overlay
8	Gravel – Not an overlay
0	Other
N	Not Applicable (applies only to structures with no deck, e.g., culverts under fill)
A	Super-plasticized Dense Concrete (SDC) Overlay
B	Chip and Seal Overlay
C	Micro-silica Modified Concrete - Overlay

## NBI # 108B - Type of Membrane

<u>Code</u>	<u>Description</u>
1	Built-up
2	Preformed Fabric
3	Epoxy
8	Unknown
9	Other
0	None
N	Not Applicable (applies only to structures with no deck)

## NBI #108C – Deck Protection

<u>Code</u>	<u>Description</u>
1	Epoxy Coated Reinforcing
2	Galvanized Reinforcing
3	Other Coated Reinforcing
4	Cathodic Protection
6	Polymer Impregnated
7	Internally Sealed**
8	Unknown
9	Other

# Ohio Bridge Inventory Guide

---

0	None
N	Not Applicable (applies only to structures with no deck)

\*\*Internally sealed: Wax beads mixed with concrete when the deck is poured. After concrete cures, deck is heated by covering with electric blankets and wax beads melt and fill the capillary openings.

*The type of wearing surface material on the structure shall be coded using one (1) of the choices given to represent the wearing surface material. Where there are multiple layers of wearing material of various types on the structure, code the top or the exposed layer. All of the codes are considered to be overlays except codes 2 (Integral Concrete), 7 (Timber) and 8 (Gravel).*

*For open Steel Grid Decks code 0 for wearing surface.*

## **NBI #109 – Average Daily Truck Traffic Percentage**

Code percentage that shows the percentage of NBI Item #29 – Average Daily Traffic that is truck traffic. Do not include vans, pickup trucks and other light delivery trucks in this percentage.

If this information is not available, an estimate which represents the average percentage of the category of road carried by the bridge may be used. Leave blank if Item 29 – Average Daily Traffic is not greater than 100.

## **NBI #110 – Designated National Network**

The national network for trucks includes most of the Interstate System and those portions of the Federal Aid Primary System Identified in the Code of Federal Regulations (23 CFR 658). The national network for trucks is available for use by commercial motor vehicles of the dimensions and configurations described in these regulations. For the inventory route identified in Item 5, indicate conditions using one (1) of the following codes:

<u>Code</u>	<u>Description</u>
0	The inventory route is not part of the national network for trucks.
1	The inventory route is part of the national network for trucks.

## **NBI #111 – Pier Protection (for Navigation)**

If NBI Item #38 – Navigation Control has been coded 1, use the codes below to indicate the presence and adequacy of pier protection features such as fenders, dolphins, etc. The condition of the protection devices may be a factor in the overall evaluation of NBI Item #60 – Substructure. If NBI Item #38 – Navigation Control has been coded 0 or N, leave blank to indicate not applicable.

<u>Code</u>	<u>Description</u>
1	Navigation protection not required
2	In place and functioning

# Ohio Bridge Inventory Guide

3	In place but in a deteriorated condition
4	In place but reevaluation of design suggested
5	None present but reevaluation suggested

## NBI #112 - NBIS Bridge Length

Does this structure meet or exceed the minimum length specified to be designed as a bridge for National Bridge Inspection Standards purposes? The following definition of a bridge is used by AASTHTO and is given in the NBIS, 23CFR650.3:

A structure including supports erected over a depression or an obstruction, such as water, highway, railway, and having a track or passageway for carrying traffic or other moving loads, and having an opening measured along the center of the roadway of more than 20 feet between under copings of abutments or spring lines of arches, or extreme ends of openings for multiple boxes; it may also include multiple pipes, where the clear distance between openings is less than half of the smaller contiguous openings.

Code	Description
Y	Yes
N	No

EXAMPLES :

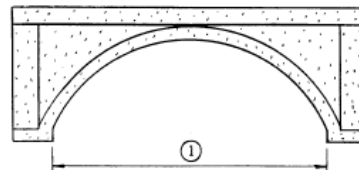
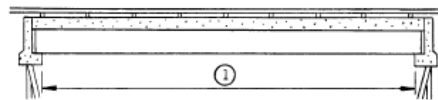
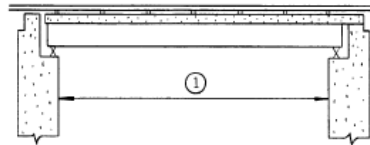

(1) Item 112 - NBIS Bridge Length

# Ohio Bridge Inventory Guide

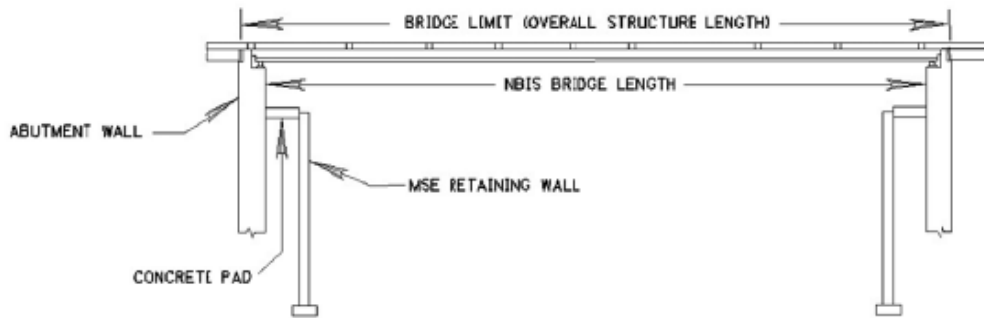

*NBIS Bridge Length is different from overall structure length. However, both lengths are measured along the centerline of the roadway. For single span structures with no bearings, clear span along the centerline of roadway determines the NBIS Length code.*

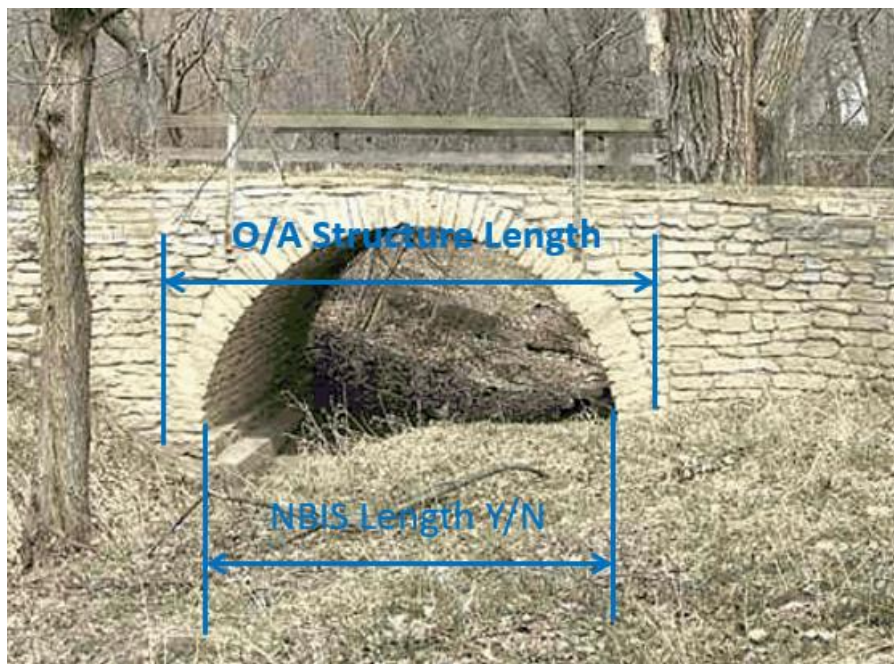



# Ohio Bridge Inventory Guide

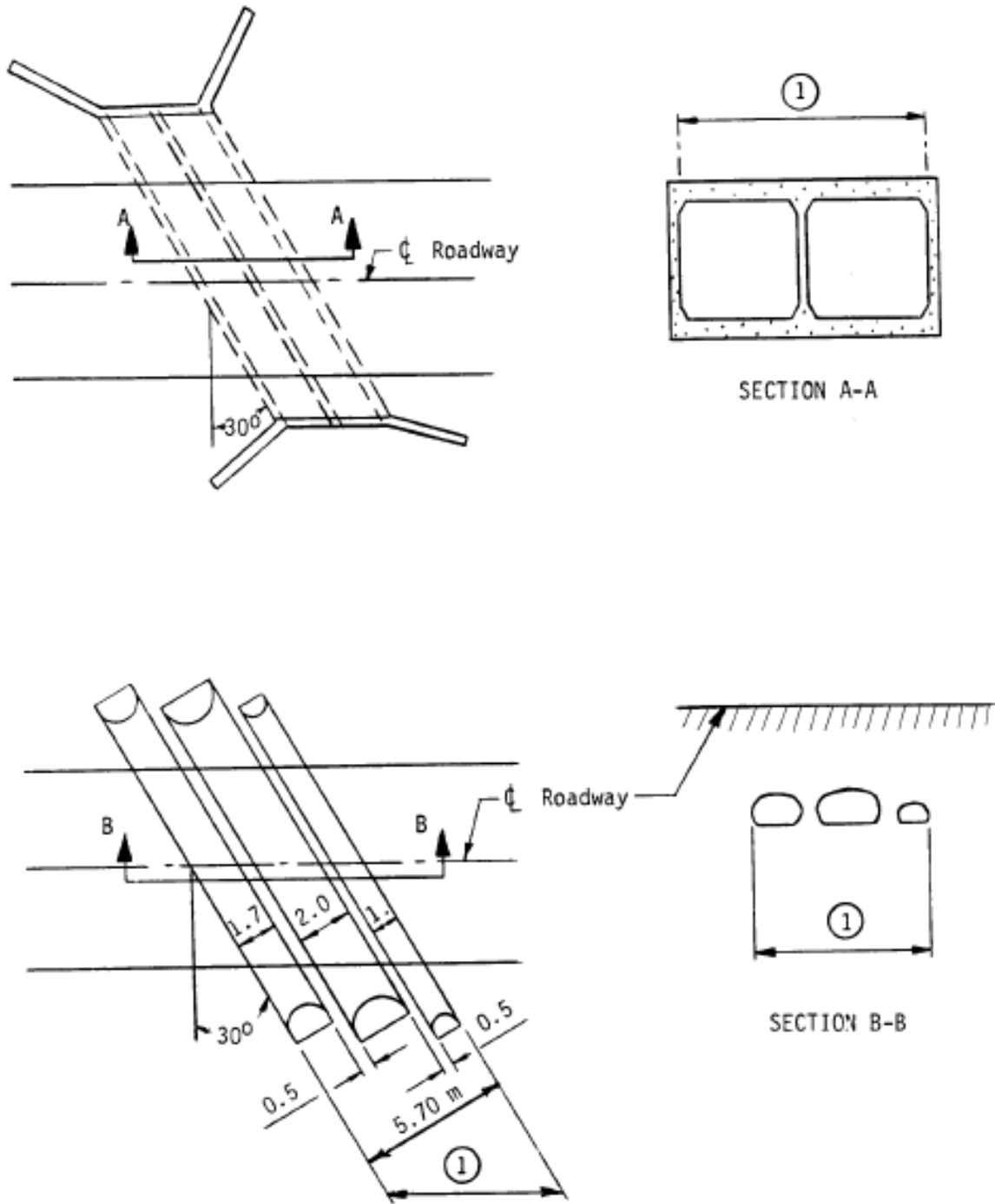

(1) Item 112 - NBIS Bridge Length

# Ohio Bridge Inventory Guide

---

## NBI #113 – Scour Critical Bridge

Code as indicated below to identify the current status of the bridge regarding its vulnerability to scour. Scour analyses shall be made by hydraulic/geotechnical/structural engineers. Details on conducting a scour analysis are included in the FHWA Technical Advisory 5140.23 titled, "Evaluating Scour at Bridges." Whenever a rating factor of 4 or below is determined for this item, the rating factor for Item 60 - Substructure may need to be revised to reflect the severity of actual scour and resultant damage to the bridge.

A scour critical bridge is one with abutment or pier foundations which are rated as unstable due to (1) observed scour at the bridge site or (2) a scour potential as determined from a scour evaluation study.

<u>Code</u>	<u>Description</u>
N	Bridge not over waterway.
U	Bridge with <b><u>unknown</u></b> foundation that has not been evaluated for scour. Since risk cannot be determined, flag for monitoring during flood events and, if appropriate, closure.
T	Bridge over <b><u>tidal</u></b> waters that has not been evaluated for scour, but considered low risk. Bridge will be monitored with regular inspection cycle and with appropriate underwater inspections. ( <b><u>Unknown</u></b> foundations in <b><u>tidal</u></b> waters should be coded U).
9	Bridge foundations (including piles) on dry land well above flood water elevations.
8	Bridge foundations determined to be stable for the assessed or calculated scour conditions; calculated scour is above top of footing. (Example A)
7	Countermeasures have been installed to correct a previously existing problem with scour. Bridge is no longer scour critical.
6	Scour calculation/evaluation has not been made. <b><u>(Use only to describe case where bridge has not yet been evaluated for scour potential.)</u></b>
5	Bridge foundations determined to be stable for calculated scour conditions; scour within limits of footing or piles. (Example B)
4	Bridge foundations determined to be stable for calculated scour conditions; field review indicates action is required to protect exposed foundations from effects of additional erosion and corrosion.
3	Bridge is scour critical; bridge foundations determined to be unstable for calculated scour conditions: <ul style="list-style-type: none"> <li>- Scour within limits of footing or piles. (Example B)</li> <li>- Scour below spread-footing base or pile tips. (Example C)</li> </ul>
2	Bridge is scour critical; field review indicates that extensive scour has occurred at bridge foundations. Immediate action is required to provide scour countermeasures.
1	Bridge is scour critical; field review indicates that failure of piers/abutments is imminent. Bridge is closed to traffic.
0	Bridge is scour critical. Bridge has failed and is closed to traffic.

*Guidance on conducting a scour evaluation is included in the FHWA Technical Advisory T5140.23 titled, "Evaluating Scour at Bridges". Detailed engineering guidance is provided in the Hydraulic Engineering Circular 18 titled, "Evaluating Scour at bridges". Whenever a rating factor of 2 or below is determined for this item, the rating factor for Item #42 – Substructure and other affected items (i.e., load ratings, superstructure rating) should be revised to be consistent with the severity of observed scour and resultant*

## Ohio Bridge Inventory Guide

---

*damage to the bridge. A plan of action should be developed for each scour critical bridge (see FHWA Technical Advisor T5140.23, HEC 18 and HEC 23). A scour critical bridge is one with abutment or pier foundation rated as unstable due to (1) observed scour at the bridge site (rating factor of 2, 1, or 0) or (2) a scour potential as determined from a scour evaluation study (rating factor of 3). It is assumed that the coding of this item has been based on an engineering evaluation, which included consultation of the NBIS filed inspection findings.*

# Ohio Bridge Inventory Guide

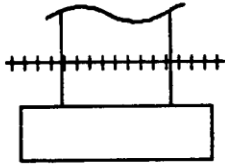
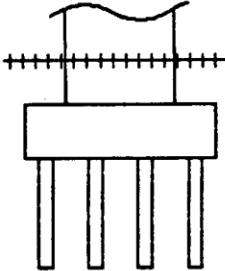
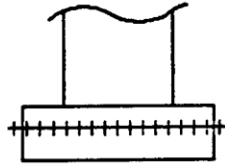
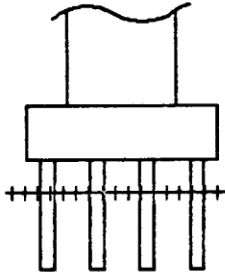
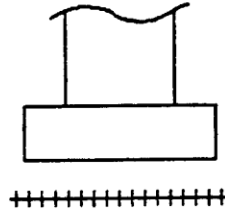
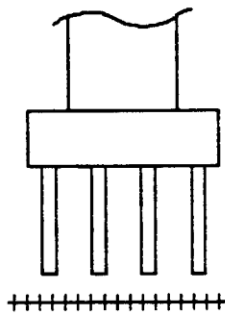
EXAMPLES:	<u>CALCULATED SCOUR DEPTH</u>	<u>ACTION NEEDED</u>
A. Above top of footing	 	None - indicate rating of 8 for this item
B. Within limits of footing or piles	 	Conduct foundation structural analysis
C. Below pile tips or spread-footing base	 	Provide for monitoring and scour countermeasures as necessary
	<p><b>SPREAD FOOTING (NOT FOUNDED IN ROCK)</b></p>	<p><b>PILE FOOTING</b></p>

+++++ = Calculated scour depth

# Ohio Bridge Inventory Guide

---

## NBI #114 – Future Average Daily Traffic

Code for all bridges the forecasted average daily traffic (ADT) for the inventory route identified in NBI Item #5. This shall be projected at least 17 years but no more than 22 years from the year of inspection. The intent is to provide a basis for a 20-year forecast. This item may be updated any time, but must be updated when the forecast falls below the 17-year limit. If planning data is not available, use the best estimate based on site familiarity.

The future ADT must be compatible with the other items coded for the bridge. For example, parallel bridges with an open median are coded as follows: if NBI Item #28 -Lanes On and Under the Structure and NBI Item #51 -

Bridge Roadway Width, Curb-to-Curb are coded for each bridge separately, then the future ADT must be coded for each bridge separately (not the total for the route).

## NBI #115 – Year of Future Average Daily Traffic

Record and code the year represented by the future ADT in Item 114. The projected year of future ADT shall be at least 17 years but no more than 22 years from the year of inspection.

## NBI #116 – Minimum Navigation Vertical Clearance, Vertical Lift Bridge

Record to the minimum vertical clearance imposed at the site as measured above a datum that is specified on a navigation permit issued by a control agency. Code this item only for vertical lift bridges in the dropped or closed position, otherwise leave blank and item will default to zeros. See examples below.

<u>Vertical Clearance</u>	<u>Code</u>
20.7	020.700
24.2	024.200

*Record to the nearest foot (rounding down) the minimum vertical clearance imposed at the site as measured above a datum that is specified on a navigation permit issued by a control agency. Code this item only for vertical lift bridges in the dropped or closed position, otherwise leave blank and item will default to zeros.*

## OHIO BRIDGE INVENTORY ITEMS

# Ohio Bridge Inventory Guide

## Ohio Item 5.01 – Priority System Code

Code if policy system of the inventory route from the table, if applicable

Code	Description
P	Priority
U	Urban
G	General
N	Not Applicable

## Ohio Item 16.01 – Latitude

Code the Latitude coordinate on the centerline of the route on the bridge at the end of the rear approach slab or start of the bridge limits traveling in the increasing direction of the Straight Line Mileage (SLM) or the County Log Point (CLP), i.e., in Cardinal direction. In case of an overhead bridge,

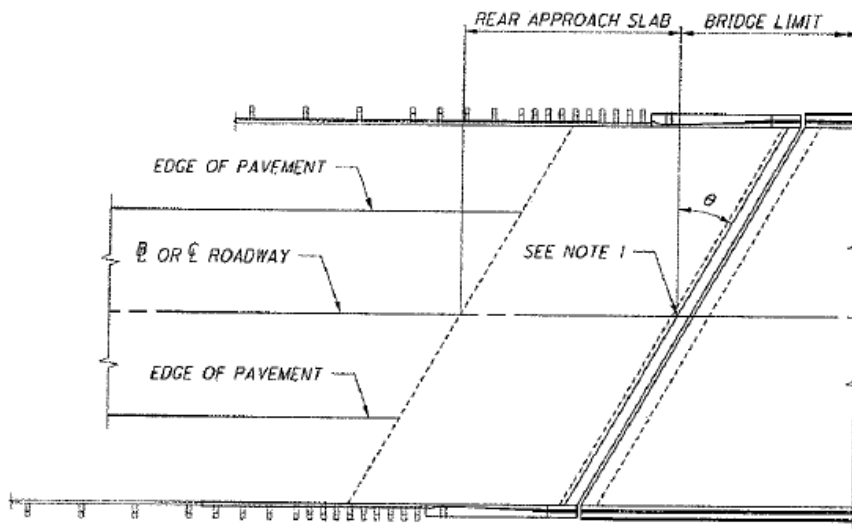

$\theta$  : SKEW ANGLE

NOTE 1:

FOR STRUCTURES WITH APPROACH SLAB, THE POINT WHERE BASELINE OR CENTERLINE OF ROADWAY INTERSECTS THE END OF THE REAR APPROACH SLAB IS THE LOCATIONS FOR SLM (MEASURED TO THREE DECIMAL POINTS), LATITUDE AND LONGITUDE BRIDGE COORDINATES (MEASURED TO SIX DECIMAL POINTS).

FOR STRUCTURES WITHOUT APPROACH SLAB, THE POINT WHERE BASELINE OR CENTERLINE OF ROADWAY INTERSECTS THE END OF THE REAR ABUTMENT BACKWALL IS THE LOCATIONS FOR SLM (MEASURED TO THREE DECIMAL POINTS), LATITUDE AND LONGITUDE BRIDGE COORDINATES (MEASURED TO SIX DECIMAL POINTS).

the coordinates shall be measured on the centerline of the inventory route under the bridge at the first bridge edge travelling in the increasing direction of the SLM or CLP. For culverts/frames under fill the coordinates shall be measured at the back of the first wall travelling in the increasing direction of the SLM or CLP. The coordinates shall be coded accurately for more than six decimal points. This coordinate is used by the mapping systems to plot the structure.

**Ohio's Limits:** (38.386333) degree – (41.978667) degree)

# Ohio Bridge Inventory Guide

## Ohio Item 17.01 - Longitude

Code the longitude coordinate on the centerline of the route on the bridge at the end of the rear approach slab or start of the bridge limits traveling in the increasing direction of the Straight Line Mileage (SLM) or the County Log Point (CLP), i.e., Cardinal direction. In the case of an overhead bridge, the coordinates shall be measured on the centerline of the inventory route under the bridge at the first

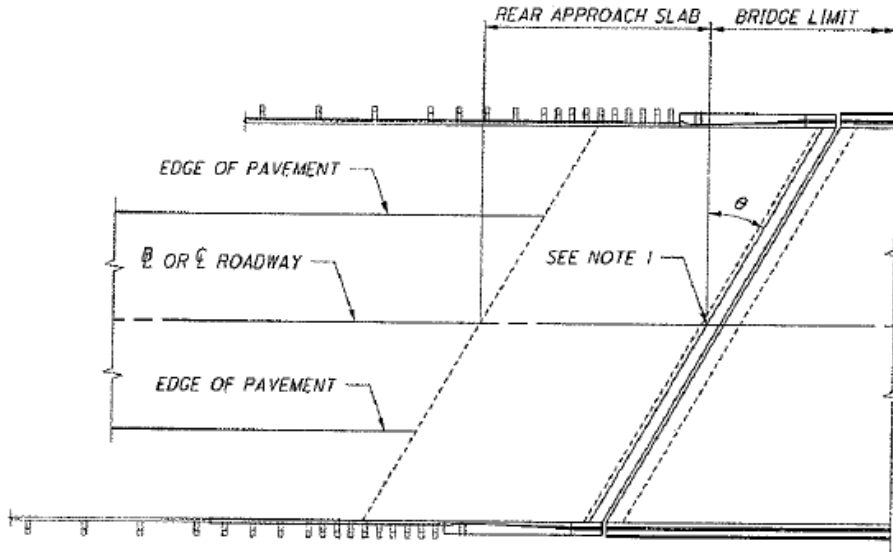

$\theta$  : SKEW ANGLE

NOTE 1:

FOR STRUCTURES WITH APPROACH SLAB, THE POINT WHERE BASELINE OR CENTERLINE OF ROADWAY INTERSECTS THE END OF THE REAR APPROACH SLAB IS THE LOCATIONS FOR SLM (MEASURED TO THREE DECIMAL POINTS), LATITUDE AND LONGITUDE BRIDGE COORDINATES (MEASURED TO SIX DECIMAL POINTS).

FOR STRUCTURES WITHOUT APPROACH SLAB, THE POINT WHERE BASELINE OR CENTERLINE OF ROADWAY INTERSECTS THE END OF THE REAR ABUTMENT BACKWALL IS THE LOCATIONS FOR SLM (MEASURED TO THREE DECIMAL POINTS), LATITUDE AND LONGITUDE BRIDGE COORDINATES (MEASURED TO SIX DECIMAL POINTS).

bridge edge travelling in the increasing direction of the SLM or CLP. For culverts/frames under fill the coordinates shall be measured at the back of the first wall travelling in the increasing direction of the SLM or CLP. The coordinates must be coded in degrees measured and coded accurate to the six decimal places. Negative sign is to be coded. This coordinate is used by the mapping systems to plot the structure.

**Ohio's Limits:** (-80.501333 degree) – (84.837667 degree)

## Ohio Item 43C - Main Structure Description

Code the main structure description using the table.

Code	Description
1	Pony Truss
2	Through Girder



# Ohio Bridge Inventory Guide

---

3	Filled Arch
N	Not applicable

## Ohio Item 43C – Approach Structure Description

Code the main structure description using the table.

Code	Description
1	Pony Truss
2	Through Girder
3	Filled Arch
N	Not applicable

## Ohio Item 58.01 – Wearing Surface

Refer to Bridge Inspection Manual

## Ohio Item 59.01 – Protective Coating System (PCS)

Refer to Bridge Inspection Manual

## Ohio Item 61.01 - Scour

Refer to Bridge Inspection Manual

## Ohio Item 67.01 – General Appraisal

Refer to Bridge Inspection Manual

## Ohio Item 70.01 – Date Posted

Code the actual date when the load posting signs were installed on the bridge, if applicable.

## Ohio Item 70.02 – Posted Sign Type

Code the type of load posting sign installed on the bridge, if applicable.

## Ohio Item 70.03 – Posted Weights

Code the posted weights in tons if bridge is posted for the reduced loads.

## Ohio Item 107.01 – Deck Structure Type

Code the additional Deck Structure type from the table.

Code	Description
1	Jack Arch
2	Slab Prestressed in both directions
3	Slab prestressed longitudinally only
4	Slab prestressed transverse only
5	Prestressed slab on beams

# Ohio Bridge Inventory Guide

---

## Ohio Item 108A.01 – Wearing Surface Description

Code additional Wearing Surface Description from the table.

Code	Description
1	Super Plasticized
2	MicroSilica
3	Chip and Seal
4	Polyester
N	Not Applicable

If wearing surface is not present, leave this item blank.

## Ohio Item 109.01 – Average Daily Truck Traffic (ADTT)

This item is located on the Historic Bridge Data page. Do not code it.

## Ohio Item 201 – Special Designation

The first position shall be used for coding “L” or “R” for Left and Right parallel structures. On divided highways with clearly separate and parallel structures for each direction of travel, each structure will carry the same straight line mileage designation, with the addition of the letter (L) for the left (non-cardinal direction) structure and (R) for the right (cardinal direction) structure.

On divided highways where the deck is continuous across both directions of travel and there is a longitudinal joint near the center of the bridge (closed median by F.H.W.A. definition), code as one (1) structure. (3” or less open joint at the centerline does not constitute parallel bridges.) Both the positions may be coded to define ramp structures by using a one (1) or two (2) character alphabetic code. Note: For ramp definitions, the letters “L” and “R” may not be used in the first position. Details on basic ramp designation schemes can be obtained from the Structure Inventory Section. Final decision on ramp designations will be made by the Structure Inventory Section.

## Ohio Item 202 – Bridge Inventory Status

Following are used in the System. Contact AWS Administrator in the ODOT CO.

Code	Description
1	<b><i>Proposed</i></b> – Incomplete Inventory, not open to traffic
2	<b><i>Inactive</i></b> – Not open to traffic
3	<b><i>Active</i></b> – Complete Inventory, open to traffic
4	<b><i>Retired</i></b> – Complete Inventory, but no longer open to traffic

## Ohio Item 203 – Bridge Name (Dedicated Name)

Code the official name (if applicable) of the bridge.

# Ohio Bridge Inventory Guide

---

**Example** – Anthony Wayne Bridge

## Ohio Item 204 – Ohio Designated MPO

Enter a two (2 digit) numeric code for the MPO in which the bridge is located. If this item does not apply, code NN for None. If the MPO is not known, code UU for Unknown.

[http://www.dot.state.oh.us/Divisions/Planning/SPR/StatewidePlanning/Pages/MPO\\_Map.aspx](http://www.dot.state.oh.us/Divisions/Planning/SPR/StatewidePlanning/Pages/MPO_Map.aspx)

<u>Code</u>	<u>Description</u>
01	AMATS (Akron)
02	BHJTS (Steubenville-Weirton)
03	Bel-O-Mar (Wheeling-Bridgeport)
04	Eastgate (Youngstown)
05	KYOVA (Huntington)
06	LCATS (Newark – Heath)
07	MORPC (Columbus)
08	NOACA (Cleveland)
09	OKI (Cincinnati)
10	SCATS (Canton)
11	MVRPC (Dayton)
12	LACRPC (Lima)
13	RCRPC (Mansfield)
14	CCSTCC (Springfield)
15	TMACOG (Toledo)
16	WWWIPC (Parkersburg-Belpre)
17	ERPC (Erie County-City of Vermilion)
NN	None
UU	Unknown

## Ohio Item 206 – Inventory Preferred Route

Code letter “P” if the inventory route is the preferred route in an overlap area. Code NP if non-preferred route. Leave blank if not in overlap area.

## Ohio Item 205 – Route Number Extension

Code the route number extension, if any. If the route number has no extension, leave it blank.

## Ohio Item 206 – Inventory Preferred Route

Code letter “P” if the inventory route is the preferred route in an overlap area. Code NP if non-preferred route. Leave blank if not in overlap area.

## Ohio Item 207 – Route Type under the Bridge

Code the Agency of the route which goes ***under*** the bridge using the codes listed below:

<u>Code</u>	<u>Description</u>
00	None of the below
10	State (ODOT) (Toll Free)

## Ohio Bridge Inventory Guide

---

11	ODNR
12	State (Other) (Toll Free)
20	Federal Domain
30	Toll Road (State)
31	Toll Road (Private)
40	County
41	Municipal
42	Township
43	Park District
44	Conservancy District
99	Non highway (i.e. pedestrian, railroad, pipeline, etc.)

For non-highway service under the bridge code “99”.

### Ohio Item 208 – Route Type on the Bridge

Code a two (2) digit numeric for the agency whose route is *carried* by the bridge.

<u>Code</u>	<u>Description</u>
00	None of the below
10	State (ODOT) (Toll Free)
11	ODNR
12	State (Other) (Toll Free)
20	Federal Domain
30	Toll Road (State)
31	Toll Road (Private)
40	County
41	Municipal
42	Township
43	Park District
44	Conservancy District
99	Non highway traffic on bridge (i.e. pedestrian, railroad, pipeline, etc.)

For bridges carrying Ohio Turnpike routes, code “30.”

### Ohio Item 209 – Interstate Mile Marker

Code a six digit number for the Interstate Mile Marker. The Interstate Mile is measured from the 0.00-mile marker at the state border to the bridge.

### Ohio Item 213 – NLF ID Inventory Route

This Item is populated by ODOT internally.

### Ohio Item 218 – Major Bridge

***This item must be coded.***

This Item shall be coded Y if it meets one (1) or more from the following criteria:

# Ohio Bridge Inventory Guide

---

- A. More than 1,000 feet in length
- B. Single bridge with a deck area of 81,000 square feet (9,000 square yards) or greater
- C. Twin bridges with a deck area of 135,000 square feet (15,000 square yards) or greater
- D. Spans the Ohio River
- E. Moveable bridge
- F. Continuous/cantilever truss bridge
- G. Suspension bridge

## Ohio Item 221 – Inspection Program Responsibility A, & B

**This item must be coded.**

The agency or agencies legally responsible should be coded in accordance with the Ohio Revised Code, or by legal agreement. Code this item to specify agency or agencies responsible for the inspection of the bridge from the table below.

**When more than one agency has this responsibility, code them in the hierarchy of State, Ohio Turnpike, Federal, County, and City, railroad and other or private.**

Code	Description
01	State Highway Agency ( <i>ODOT</i> )
02	County Highway Agency
03	Town or Township Highway Agency
04	City or Municipal Highway Agency
11	State Park, Forest or Reservation Agency ( <i>ODNR</i> )
12	Local Park, Forest or Reservation Agency
21	Other State Agencies
25	Other Local Agencies
26	Private (other than railroad)
27	Railroad
31	State Toll Agency ( <i>OTP</i> )
32	Local Toll Agency
60	Other Federal Agencies (not listed below)
61	Indian Tribal Government
62	Bureau of Indian Affairs
63	Bureau of Fish and Wildlife
64	U. S. Forest Service
66	National Park Service
67	Tennessee Valley Authority
68	Bureau of Land Management
69	Bureau of Reclamation
70	Corps of Engineers (Civil)
71	Corps of Engineers (Military)

## Ohio Bridge Inventory Guide

---

72	Air Force
73	Navy/Marines
74	Army
75	NASA
76	Metropolitan Washington Airports Service
80	Unknown

### Ohio Item 224 – Temporary Sub decking

Code **Y** for Yes if feature **does** exist and **N** for No if feature **does not** exist.

### Ohio Item 225 – Routine Maintenance Responsibility A & B

***This item must be coded.***

The agency or agencies legally responsible should be coded in accordance with the Ohio Revised Code, Roadway Infrastructure Maintenance Responsibility Manual or by legal agreement. Code a numeric or alphanumeric code to specify agency or agencies responsible for the routine maintenance from the table below, where the agency with the left-most code is the one with primary responsibility. ***When more than one agency has equal responsibility, code them in the hierarchy of State, Ohio Turnpike, Federal, County, and City, railroad and other or private.***

(<http://portal.dot.state.oh.us/Divisions/Operations/MaintAdmin/Reference%20Materials/RIMR.pdf#search=rimr>)

<b>Code</b>	<b>Description</b>
01	State Highway Agency (ODOT)
02	County Highway Agency
03	Town or Township Highway Agency
04	City or Municipal Highway Agency
11	State Park, Forest or Reservation Agency (ODNR)
12	Local Park, Forest or Reservation Agency
21	Other State Agencies
25	Other Local Agencies
26	Private (other than railroad)
27	Railroad
31	State Toll Agency (OTP)
32	Local Toll Agency
60	Other Federal Agencies (not listed below)
61	Indian Tribal Government
62	Bureau of Indian Affairs
63	Bureau of Fish and Wildlife
64	U. S. Forest Service
66	National Park Service
67	Tennessee Valley Authority
68	Bureau of Land Management
69	Bureau of Reclamation

## Ohio Bridge Inventory Guide

---

70	Corps of Engineers (Civil)
71	Corps of Engineers (Military)
72	Air Force
73	Navy/Marines
74	Army
75	NASA
76	Metropolitan Washington Airports Service
80	Unknown

### Ohio Item 226 – Seismic Susceptible

Code this item according to the following table:

<u>Code</u>	<u>Description</u>
1	Unreinforced masonry (laid-up stone abutments and piers)
2	Simple span approaches to large truss bridges
3	Prestressed I or box beams <b><i>if not</i></b> tied together over the piers <b><i>or</i></b> pinned into the piers and abutments
4	Non-redundant steel pier caps which are not tied to either the pier columns or other bridge superstructure
5	Multiple column type piers with no pier cap
6	Bridges with centerline of bearing 4” or less to face of abutment or pier
7	Bridge with seated hinges (not pins and hangers)
N	Not applicable

### Ohio Item 227 – GASB (Governmental Accounting Standards Board)

Code a Y or N to indicate if the bridge meets the GASB definition.

GASB Bridge - All State System Bridges excluding Major Bridge, ODNR, Turnpike, and Non-Highway bridges not maintained by ODOT.

### Ohio Item 236 – Future Traffic Factor

Code a factor to predict future traffic (ADT), if available.

### Ohio Item 245 – Aperture Cards Fabrication

Code a Y or N to indicate if the Fabrication Aperture Cards are available for the bridge.

### Ohio Item 246 – Aperture Cards Original

Code a Y or N to indicate if the Original Aperture Cards are available for the bridge.

### Ohio Item 247 – Aperture Cards Repair

Code a Y or N to indicate if the Repair Aperture Cards are available for the bridge.

# Ohio Bridge Inventory Guide

---

## Ohio Item 248 – Original Construction Project Number

Code the number of the Ohio Project which the structure was originally constructed. Agencies other than the State may code this item using any numeric system which fits within the nine (9) digits field provided. If non-state agencies choose not to code or the State project number is unknown, leave this item blank.

Note: See also ***Appendix E***

## Ohio Item 251 – Standard Drawing Number

Code the Standard Drawing Number for the bridge superstructure.

## Ohio Item 252 – Microfilm Reel Number

Code any Microfilm Reel Numbers that contain information about the bridge.

## Ohio Item 253 – SFN Replacing This Retired Bridge

Code the seven (7) digits SFN of the bridge which is replacing, if this bridge is being retired.

## Ohio Item 255 – SFN That Was Replaced by This Bridge

Code the seven (7) digits SFN of the bridge that was replaced by this Bridge.

## Ohio Item 257 – Record Retiring Reason

This item is coded by the ODOT CO at the time of retiring a SFN. Code the reason to retire a SFN based on the following table:

1 - Replaced ( $\geq$ 50% Suff Rating)
2 - Replaced ( $<$ 50% Suff Rating)
3 - Abandoned (not on public route)
4 - Collapsed, not to be replaced
5 - Closed, not to be replaced
7 - Collapsed and replaced
0 - Other

## Ohio Item 258 – Date Open to Traffic

Code the date when the traffic was first time opened on a new bridge. For part-width or phased construction, code the date when the traffic is opened in the first phase.

## Ohio Item 259 – Record Add Date

This item is coded by the ODOT CO. Code the date when a proposed SFN is made active first time.

## Ohio Item 260 – Record Retire Date

This item is coded by the ODOT CO. Code the date when a SFN is retired.



# Ohio Bridge Inventory Guide

---

## Ohio Item 261 – Bridge Remarks

This item is coded by the ODOT CO. Code the remarks, if any.

## Ohio Item 263 – Date Built

**This Item must be coded for all bridges.**

Code the actual day, month and year the bridge was completed, if unknown code 07/01/1900.

<u>Examples</u>	<u>Code</u>
Built June 30, 1928	06/30/1928
If you cannot determine the date when a bridge was built.	07/01/1900
A bridge was built in 1935; date and month are unknown	07/01/1935

For bridges constructed in part-width, code the date when the first portion of bridge deck under the travel lanes was completed.

## Ohio Item 264 – Major Reconstruction Date

**This item must be coded only for bridges on which major reconstruction has been done.**

Code the date in month, day and year of the most recent major reconstruction (rehabilitation) of the structure. **Item 264 cannot be equal or earlier than Item 263.**

Replacement of an entire deck, entire superstructure or work of a greater magnitude should be termed "Major Reconstruction". Beyond these guidelines "Major Reconstruction" will be a judgmental determination, by a qualified person in the agency.

**Some types of work not to be considered as major reconstruction are listed below:**

- Safety feature replacement or upgrading (for example, bridge rail, approach or impact attenuators).
- Painting of structural steel.
- Overlaying of bridge deck as part of a larger highway re-surfacing project (for example overlay carried across bridge deck for surface uniformity without additional bridge work).
- Utility work.
- Emergency repair to restore structure integrity to the previous status following an accident.
- Retrofitting to correct a deficiency which does not substantially alter physical geometry or increase the load carrying capacity.
- Work performed to keep a bridge operational while plans for complete rehabilitation or replacement are under preparation (for example, adding a substructure element or extra girder).

<u>Examples</u>	<u>Code</u>
Built on May 1, 1898; Major Reconstructions in October 10, 1949 & July 1, 1964	07/01/1964

# Ohio Bridge Inventory Guide

If there has never been Major Reconstruction on the bridge	<u>Leave blank</u>
--	--------------------

## Ohio Item 265 – Electric Line Present

Code **Y** for Yes if feature **does** exist and **N** for No if feature **does not** exist.

## Ohio Item 266 – Gas Line Present

Code **Y** for Yes if feature **does** exist and **N** for No if feature **does not** exist.

## Ohio Item 269 – Sanitary Sewer Present

Code **Y** for Yes if feature **does** exist and **N** for No if feature **does not** exist.

## Ohio Item 301 – Horizontal Curve

This item must be coded for all structures, where the route carried by the structure is located within a horizontal curve. Code this item to the nearest degree and minute.

If the structure is entirely or primarily on a tangent, leave this item blank. For structures on a curve code the curve. For structures on a spiral code the spiral as 9999. And for non-tangent structures of unknown curvature code them 0000.

<u>Curve</u>	<u>Code</u>
18 degrees – 30'	1830
25 degrees – 06'35"	2507
Spiral	9999
Curve Unknown	0000

- $D_c$  = DEGREE OF HORIZONTAL CURVE
- E = EXTERNAL DISTANCE
- $\Delta$  = INTERSECTION ANGLE
- LC = LENGTH OF CHORD
- M = MIDDLE ORDINATE
- PC = POINT OF CURVATURE
- PI = POINT OF INTERSECTION
- PT = POINT OF TANGENT
- R = RADIUS
- T = TANGENT DISTANCE

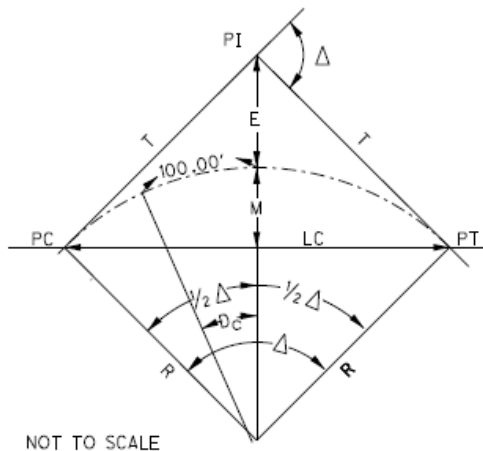

# Ohio Bridge Inventory Guide

---

## Ohio Item 306 – NBIS Bridge Length

Code this item for the NBIS Bridge Length using the following method of measurement:

Measure along the centerline of the roadway between under copings of abutments or spring lines of arches, or extreme ends of openings for multiple boxes; it may also include multiple pipes, where the clear distance between openings if less than half of the smaller contiguous openings.

**NOTE:** NBIS Bridge Length is different from overall structure length. However, both lengths are measured along the centerline of the roadway. For single span structures with no bearings clear span along the centerline of roadway is the NBIS Length.

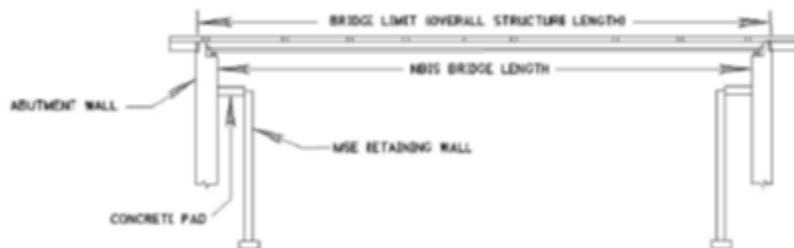

# Ohio Bridge Inventory Guide

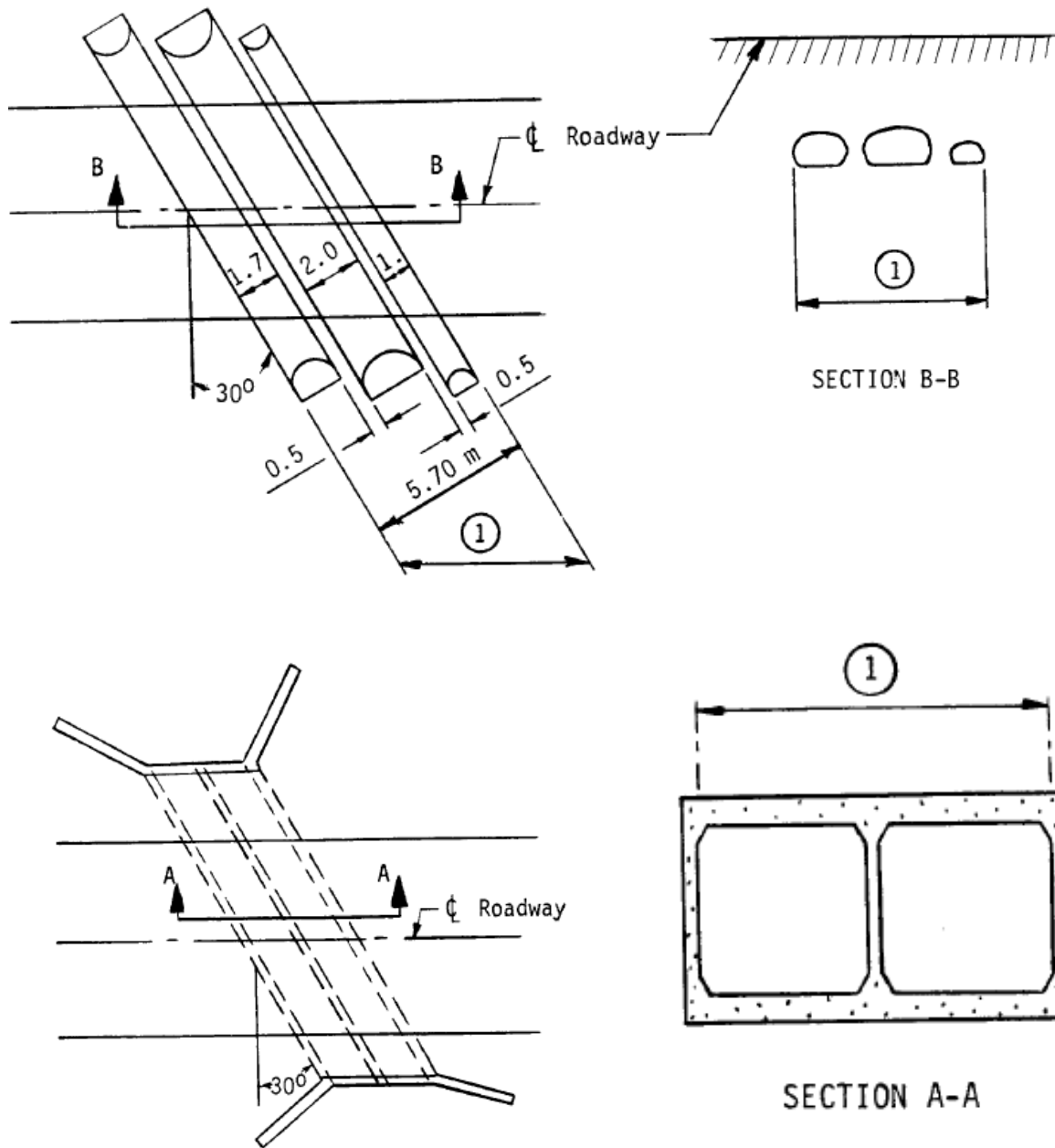

## Ohio Item 335A - Minimum Horizontal Clearance - Inventory Route, Cardinal

This item refers to the bridge roadway horizontal clearance on the bridge in feet. Code the available clearance measured normal to the centerline of roadway between restrictive features such as curbs, railings, sidewalks, wheel guards, raised medians and other structural features limiting the roadway surface width in the cardinal direction. Raised Button –Type medians and small raised lane channeling curbs, etc. are not considered restrictions.

If more than one (1) roadway exists, a measurement should be made for each, but only the horizontal clearance of the mainline in each direction of travel shall be coded.

# Ohio Bridge Inventory Guide

---

***The purpose of this item is to give the largest available horizontal clearance for the movement of wide loads on the bridge.*** If a single or non-divided roadway is present, the clearance figure shall be coded in the space of the “Cardinal” opening and all zeros shall be coded under Non-Cardinal opening. For ***culvert type structures*** which have no deck, the coded clearance should show the ***full width of the pavement; plus shoulder except where this dimension is limited by guardrail, culvert end-walls, etc.*** All clearances are to be coded in feet.

## **Ohio Item 335B – Minimum Horizontal Clearance - Inventory Route Non-Cardinal**

This item refers to the bridge roadway horizontal clearance on the bridge in feet. Code the available clearance measured normal to the centerline of roadway between restrictive features such as curbs, railings, sidewalks, wheel guards, raised medians and other structural features limiting the roadway surface width in the cardinal direction. Raised Button –Type medians and small raised lane channeling curbs, etc. are not considered restrictions.

If more than one (1) roadway exists, a measurement should be made for each, but only the horizontal clearance of the mainline in each direction of travel shall be coded.

***The purpose of this item is to give the largest available horizontal clearance for the movement of wide loads on the bridge.*** If a single or non-divided roadway is present, the clearance figure shall be coded in the space of the “Cardinal” opening and all zeros shall be coded under Non-Cardinal opening. For ***culvert type structures*** which have no deck, the coded clearance should show the ***full width of the pavement; plus shoulder except where this dimension is limited by guardrail, culvert end-walls, etc.*** All clearances are to be coded in feet.

## **Ohio Item 336A – Minimum Vertical Clearance -Inventory Route Cardinal**

***This item must be coded.***

Code Minimum Vertical Clearance ON the Inventory Route to any restriction above in the cardinal direction of travel. If there are multiple openings, code the minimum clearance for all the openings in the cardinal direction of travel. For highways with one (1) way traffic on the structure, code the minimum clearance under the appropriate subtitle. Code the entire item with zeros for structures which do not carry a highway. When no superstructure restriction exists above bridge roadway code 99.999.

## **Ohio Item 336B – Minimum Vertical Clearance -Inventory Route Non-Cardinal**

***This item must be coded.***

Code Minimum Vertical Clearance ON the bridge roadway to any superstructure restriction in feet on the bridge in the non-cardinal direction of travel. If there are multiple openings, code the minimum clearance for all the openings in the non-cardinal direction of travel. For highways with one (1) way traffic on the structure, code the minimum clearance under the appropriate subtitle. Code the entire item with zeros for structures which do not carry a highway. When no superstructure restriction exists above bridge roadway code 99.999.

# Ohio Bridge Inventory Guide

---

## Ohio Item 404 – Approach Slab Type

This item indicates the type of approach slab for the structure. The primary function of the approach slab is to carry traffic from compacted in-situ soil over disturbed soil to more rigid bridge structure.

<u>Code</u>	<u>Description</u>
1	Reinforced Concrete
2	Prestressed Concrete
3	None
4	Unknown



## Ohio Item 405 – Approach Slab Length

If Item 404 is coded Y for yes then code the length of the approach slab to the nearest foot. If Item 404 is coded none leave it blank.

## Ohio Item 406 – Bridge Median Type

This item has three parts.

1. Code if the median on the deck is levelled, raised or not present.

<u>Code</u>	<u>Description</u>
1	Level Median
2	Raised Median
N	None or not present

# Ohio Bridge Inventory Guide

---

All culverts with fill and grass median code N for None.

2. If median is present, code the type of median from the table below:

1 - Steel Barrier (Rail)
2 - Concrete Barrier (Rail)
3 - 32" Deflector Type (New Jersey Shape)
4 - 42" Deflector Type (New Jersey Shape)
<b>5 - 50" Deflector Type (New Jersey Shape)</b>
6 - 32" Deflector Type (General Motors Shape)
7 - 36" Deflector Type (New Jersey Shape)
N - Non Barrier
0 - Other (Barrier)

3. If a median joint exists, code the type of joint:

<b>1 - Open Joint</b>
2 - Filled Joint
N - No Joint
Blank

## Ohio Item 407 – Bridge Railing Type

***This item must be coded.***

Code a one (1) digit numeric for the type of bridge railing.

<u>Code</u>	<u>Description</u>
1	Reinforced Concrete Parapet
2	Reinforced Concrete and Steel
3	Reinforced Concrete Safety Curb and Parapet with Aluminum Railing
4	Reinforced Concrete Post and Steel Panel
5	Reinforced Concrete Post and Concrete Panel
6	Steel Post and Steel Panel
7	Steel Guardrail on Steel, Concrete or Timber Posts
8	Timber
9	Twin Steel Tube (TST) Bridge Railing

## Ohio Bridge Inventory Guide

---

A	Deep Beam Railing (DBR) with Tubular Backup
B	Tri-Beam
C	32" Deflector Type Parapet (New Jersey Shape)
D	42" Deflector Type Parapet (New Jersey Shape)
E	50" Deflector Type Parapet (New Jersey Shape)
F	32" Deflector Type Parapet (General Motors Shape)
G	36" Deflector Type Parapet (New Jersey Shape)
H	57" Deflector Type Parapet (Single Slope)
I	42" Deflector Type Parapet (Single Slope)
J	DBR with Retrofit
K	Not Used
L	Not Used
M	Masonry
N	None
O	Other

When more than one type of railing exists on the bridge, code the item for the predominate type. If railing type cannot be determined code "O". If no railing exists on the structure; such as for culverts; code N.

### Ohio Item 408 – Composite Deck Code

This item will reflect whether a structure is built composite (i.e. beams w/shear connectors) by using the following codes. Also considered to be composite are structures with steel beams encased in concrete and jack arch bridges.

**Do not code bridges with composite material here.**

<u>Code</u>	<u>Description</u>
N	Non-composite Construction
Y	Composite Construction
X	Not Applicable
U	Unknown

**If the bridge carries non-highway traffic (i.e. railroad, pipeline, pedestrian, etc.) or if the structure is a culvert; code X for not applicable.**

**This item must be coded for all bridges.**



# Ohio Bridge Inventory Guide

---

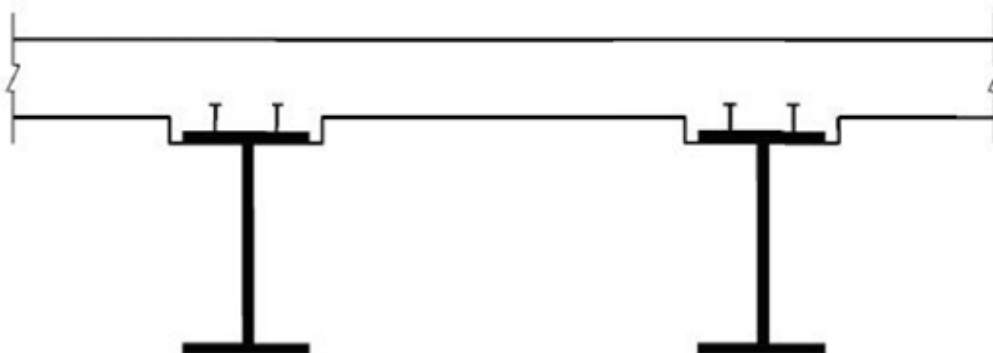

## Ohio Item 409 - Deck Drainage Type

Code a one (1) digit numeric for the drainage system listed below which most nearly describes that on the structure.

<u>Code</u>	<u>Description</u>
1	Over the side (without drip strip)
2	Opening thru curbs or wheel guards
3	Scuppers and downspouts
4	Inlets with drain pipes
5	Drainage trough under open joints
6	Over the side (with drip strip)
N	None
0	Other (Natural off the bridge ends)

If no deck exists, such as for most culverts, code N for None.

**This item must be coded for all highway.**

## Ohio Item 411 - Deck Concrete Type

Code the appropriate type concrete for the deck from the table below:

<u>Code</u>	<u>Description</u>
1	Class C
2	Class S Superstructure
3	Class S Superstructure using shrinkage compensating cement
4	Class S Superstructure with Type 2 cement
5	High Performance Concrete Superstructure, Type 3
6	High Performance Concrete Superstructure, Type 4

## Ohio Bridge Inventory Guide

---

7	Super-plasticized Concrete
8	Pre-cast Concrete (5,000 psi minimum)
0	Other
A	QSC1 – Substructure concrete
B	QSC2 – Superstructure concrete
C	QSC3 – Project specific
N	None or Not Applicable
U	Unknown

### Ohio Item 414A, B & C – Expansion Joint Type

You may code up to three (3) different types of expansion joints for a bridge. Code this item using one of the codes in the table below.

Code	<u>Description</u>
1	Metal Finger
2	Sliding Metal Plate Angle
3	Compression Seal
4	Poured
5	Open (Armored)
6	Open (Unarmored)
7	Steel Reinforced Elastomeric
8	Elastomeric Strip Seal
N	None
0	Other
A	Modular
B	Polymer modified expansion device

### Ohio Item 419 – Expansion Joint W/Trough Retrofit

Code Y for yes or N for no to indicate the presence of an elastomeric trough installed as part of the expansion joint system retrofit or code item N if not applicable.

### Ohio Item 421 – Expansion Joint W/Trough

Code Y for yes or N for no to indicate if an expansion joint with trough is present or not.

### Ohio Item 422 – Wearing Surface Date

**This item must be coded for all highway bridges.**

Code the month, day and year of the most recent wearing surface application (i.e. concrete overlays, bituminous, etc.)

If NBI Item #108A is coded 1 thru 9, this item must be coded. If not applicable, leave this item blank.

# Ohio Bridge Inventory Guide

---

## Ohio Item 423 – Wearing Surface Thickness

**This item must be coded for all highway bridges.**

Whether the wearing surface is a separate wearing surface material or monolithic concrete, code the total thickness rounded to the nearest inch. For decks with monolithic concrete wearing surface, code a nominal 1” thickness. Where there are multiple layers of wearing materials of different types on the structure code the total thickness of all materials including any monolithic concrete.

Leave this item blank if not applicable.

## Ohio Item 424 – Deck Area

This is a calculated field.

The Deck Area is a product of the Bridge Deck Width (NBI #52) and Structure Length (NBI #49). In case of culverts, the deck area is product of the Approach Roadway width (NBI #32).

## Ohio Item 427 – Left Sidewalk/Curb Material

Code the material of sidewalk or curb from the table.

<u>Code</u>	<u>Description</u>
1	Concrete
2	Steel
3	Timber
N	None
0	Other

## Ohio Item 428 – Left Sidewalk/Curb Type

Code the most appropriate type of sidewalk or curb on the bridge.

<u>Code</u>	<u>Description</u>
1	Safety Curb (2’ or less width)
2	Sidewalk (greater than 2’ in width)
3	Felloe Guards
4	Open Grid
5	Filled Grid
6	Check Plate
N	None or N/A (RR, Pedestrian, etc.)
0	Other

## Ohio Item 429 – Right Sidewalk/Curb Material

Code the material of sidewalk or curb from the table.

<u>Code</u>	<u>Description</u>
1	Concrete
2	Steel

## Ohio Bridge Inventory Guide

---

3	Timber
N	None
0	Other

### Ohio Item 430 – Right Sidewalk/Curb Type

Code the most appropriate type of sidewalk or curb on the bridge.

Code	Description
1	Safety Curb (2' or less width)
2	Sidewalk (greater than 2' in width)
3	Felloe Guards
4	Open Grid
5	Filled Grid
6	Check Plate
N	None or N/A (RR, Pedestrian, etc.)
0	Other

### Ohio Item 431 – Fence

Code this item Y or N to indicate if a fence is present on the bridge.

Code	Description
N	Fence is not on the bridge
Y	Fence is on the bridge

### Ohio Item 434 – Noise Barrier Walls

Code this item Y or N to indicate if noise barrier is present on the bridge.

Code	Description
N	Noise barrier is not on the bridge
Y	Noise barrier is present on the bridge

### Ohio Item 453 – Bearing Device 1, Type

Code the bearing devices on the bridge from the table.

Code	Description
1	Rollers
2	Rockers & Bolsters
3	Sliding (Bronze)
4	Elastomeric (Plain)
5	Pot
6	Spherical
7	Disc
8	Fixed Arch-Rib
N	None

# Ohio Bridge Inventory Guide

---

0	Other
A	Sliding (Other)
B	Fixed
C	Elastomeric (laminated)
D	Integral & semi-integral abutment bearings

For integral & semi-integral type abutments code D. For structures which have no superstructure, such as culverts, code **N**.

## Ohio Item 455 - Bearing Device 2, Type

If more than one type of bearing devices are present, code the second type from the table given for Ohio Item 453.

## Ohio Item 459 - Inspection Access System

Code this item if Inspection Access System is present on the bridge

Y - The bridge includes this feature

**N - The bridge does not include this feature**

Blank

## Ohio Item 465 - Framing Type

Code the appropriate framing type for pre-stressed concrete I-beam, steel beam or steel girder bridges.

<u>Code</u>	<u>Description</u>
1	Curved Beams/Girders Framing
2	Dog-legged or Kinked Framing
3	Flared Beams/Girders Framing
4	Straight Beams/Girders Framing
0	Other Framing
N	None or Not Applicable

Code "N" if it not applicable (example: concrete slabs, timber, culverts, trusses, etc.)

## Ohio Item 466 - Haunched Girder

This item indicates if the bridge has a haunched girder.

<u>Code</u>	<u>Description</u>
Y	Bridge contains a haunched girder
N	Bridge does not contain a haunched girder

# Ohio Bridge Inventory Guide

---

## Ohio Item 467 – Haunched Girder Depth

Measure and record the depth of the haunch (depth over pier or abutment) of the girder if Ohio Item #466 is coded Y. If Ohio Item #466 is coded N leave this item blank. The depth should be recorded in feet up to three decimal points.

<u>Haunched Girder Depth</u>	<u>Code</u>
6 ft. 10 inches	6.833
5 ft. 2 inches	5.167

## Ohio Item 468 – Hinges/Pins/Hangers Type

Code the type of hinges on the bridge. Code N for none, if not applicable.

<u>Code</u>	<u>Description</u>
1	Pins & Hangers
2	Pins, Pin Plates
3	Seated Hinges (Rollers, Plates, Pot Bearings)
4	Other (includes Strut)
N	Not Applicable (structures with no hinges)

## Ohio Item 474 – Main Structure System

Code the type of main bridge member of which the bridge is constructed, from the list below:

<u>Code</u>	<u>Type</u>
1	Two (2) Girder Bridge
2	Three (3) Girder Bridge
3	Four (4) or More Girder bridge
4	Two (2) Trusses (Welded)
5	Two (2) Trusses (Riveted)
6	Three (3) or More Trusses (Welded)
7	Three (3) or More Trusses (Riveted)
0	Other
A	Two (2) or more Steel Arches (Welded)
B	Two (2) or more Steel Arches (Riveted)
C	Two (2) Concrete Arches
D	Three (3) Concrete Arches
E	Four (4) or more Concrete Arches
F	Jack Arch
G	One (1) Concrete Arch
N	Not Applicable (i.e. Culvert, Beam, Slab, etc.)

## Ohio Item 475 – Main Member Type

This item must be coded for any structure whose main span is of the girder, beam or slab type regardless of material.

Select the appropriate code from the following list. If item is not applicable code it N.

## Ohio Bridge Inventory Guide

---

<u>Code</u>	<u>Type</u>
1	Rolled Steel
2	Riveted Built-Up Steel
3	Welded Built-Up Steel
4	Concrete Tee Beam
5	Concrete Girder
6	Prestressed Concrete Box Beam
7	Prestressed Concrete I Beam
8	Timber
9	Segmental Box Girder
0	Other (Concrete Rigid Frame)
A	Channel Beam
B	Cast-In-Place Concrete Box Beam
C	Slab
N	Not Applicable (Culverts, Trusses, Arches, etc.)

### Ohio Item 478 – Post Tensioned Main Member Code

Code the item to indicate if the bridge is post tensioned.

<u>Code</u>	<u>Description</u>
Y	Bridge is Post Tensioned
N	Bridge is not Post Tensioned

### Ohio Item 482 – Protective Coating System (PCS) Type

Use the appropriate code from the list below to indicate the protective coating system.

<u>Code</u>	<u>Protective Coating Type</u>
1	Red lead
2	Unpainted Weathered Steel
3	Paint System A
4	Paint System B
5	Paint System OZEU
6	Galvanized
7	Metalized (Alum/Zinc)
8	Paint System A with intermediate tie coat
9	Paint System IZEU
0	Other Paint
A	EEU
B	Epoxy – Urethane sealers
C	Non-Epoxy sealers
N	None or Not Applicable
U	Unknown Sealant

# Ohio Bridge Inventory Guide

---

This item (when applicable) should be coded for all structures.

## [Ohio Item 483 – Protective Coating System \(PCS\) Date](#)

This item should reflect the most recent date the Protective Coating System was applied to the bridge.

## [Ohio Item 487 – Structural Member Steel Type](#)

Code the predominant type of structure steel (beams, girders, cross frames, etc.) used for the bridge from the table.

<u>Code</u>	<u>Type</u>
1	A588 (Weathering Steel)
2	A572
3	A441
4	A440
5	A373
6	A242
7	A36
8	A7
9	A6
0	Other
A	Wrought Iron
B	Hybrid (A572 or A588 flanges with A36 webs)
C	Hybrid (A709 grade 70W flanges with 50W webs)
D	A709 Grade 50
E	A709 Grade 50W
N	None
U	Unknown

## [Ohio Item 499 – Structural Steel Paint](#)

Indicate where the prime coat of paint was applied to structural steel from the list of codes below:

<u>Code</u>	<u>Location</u>
1	Shop
2	Field
3	Combination (Shop & Field)
U	Unknown
N	None (i.e. steel = A588, unpainted)

## [Ohio Item 526 – Abutment Forward Type](#)

Code the type of abutment. If the structure has no abutments code **N**.

<u>Code</u>	<u>Description</u>
1	Gravity
2	Cantilever



## Ohio Bridge Inventory Guide

---

3	Solid Wall
4	Cellular or "U"
5	Stub Gravity
6	Stub-Capped Pile (Single Row Piles)
7	Integral
8	Pedestal
9	Stub-Capped Pile (Multiple Row Piles)
0	Other
N	None
A	Proprietary Wall w/Stub Type Abutments
B	Capped Pile Bent
C	Cap & Column
D	Semi-Integral

### Ohio Item 527 - Abutment Forward - Material Type

Code the material of each abutment. If the structure has no abutments code **N**.

<u>Code</u>	<u>Description</u>
1	Stone
2	Concrete
3	Concrete and Stone
4	Timber
5	Steel
6	Steel and Timber
7	Steel and Concrete
N	None
0	Other

### Ohio Item 528 - Abutment Forward - Foundation Type

Code the type of foundation for the abutment. If there are no abutments code "N" for none. For three-sided precast concrete structures, code spread footings or pile type foundation accordingly. For four-sided boxes code foundations as "**N**" for **none**.

<u>Code</u>	<u>Type</u>
1	Steel H Piles (Other size)
2	Cast-in-Place Reinforced Concrete Piles (Other diameter)
3	Drilled Shafts
4	Spread Footing
5	Timber Piles
6	Rock
7	Steel H Piles (HP 10 x 42)
8	Steel H Piles (HP 12 x 53)
9	Steel H Piles (HP 14 x 73)
0	Other
U	Unknown (Older Bridge being added to the file and foundations are unknown)

## Ohio Bridge Inventory Guide

---

N	None (such as most Culverts) (Code all N's)
A	Cast-in-Place Reinforced Concrete Piles (12" diameter)
B	Cast-in-Place Reinforced Concrete Pile (14" diameter)
C	Cast-in-Place Reinforced Concrete Pile (16" diameter)

This item must be coded for all structures.

### Ohio Item 531 - Abutment Rear Type

Code the type of abutment. If the structure has no abutments code **N**.

<b>Code</b>	<b>Description</b>
1	Gravity
2	Cantilever
3	Solid Wall
4	Cellular or "U"
5	Stub Gravity
6	Stub-Capped Pile (Single Row Piles)
7	Integral
8	Pedestal
9	Stub-Capped Pile (Multiple Row Piles)
0	Other
N	None
A	Proprietary Wall w/Stub Type Abutments
B	Capped Pile Bent
C	Cap & Column
D	Semi-Integral

### Ohio Item 532 - Abutment Rear - Material Type

Code the material of abutment. If the structure has no abutments code **N**.

<b>Code</b>	<b>Description</b>
1	Stone
2	Concrete
3	Concrete and Stone
4	Timber
5	Steel
6	Steel and Timber
7	Steel and Concrete
N	None
0	Other

# Ohio Bridge Inventory Guide

---

## Ohio Item 533 – Abutment Rear - Foundation Type

Code the type of foundation for the abutment. If there are no abutments code “N” for none. For three-sided precast concrete structures, code spread footings or pile type foundation accordingly. For four-sided boxes code foundations as “**N**” for **none**.

<u>Code</u>	<u>Type</u>
1	Steel H Piles (Other size)
2	Cast-in-Place Reinforced Concrete Piles (Other diameter)
3	Drilled Shafts
4	Spread Footing
5	Timber Piles
6	Rock
7	Steel H Piles (HP 10 x 42)
8	Steel H Piles (HP 12 x 53)
9	Steel H Piles (HP 14 x 73)
0	Other
U	Unknown (Older Bridge being added to the file and foundations are unknown)
N	None (such as most Culverts) (Code all N's)
A	Cast-in-Place Reinforced Concrete Piles (12” diameter)
B	Cast-in-Place Reinforced Concrete Pile (14” diameter)
C	Cast-in-Place Reinforced Concrete Pile (16” diameter)

This item must be coded for all structures.

## Ohio Item 534 – Pier 1 (Predominate) Type

Code the predominate type of pier using the table below, if pier is present. If there are no piers code “**N**” for none.

<u>Code</u>	<u>Type</u>
1	Gravity
2	Cantilever (Tee) Open Panel
3	Cantilever (Tee) Solid Panel
4	Open Column
5	Capped Column
6	Straddle Bent Column
8	Capped Pile
0	Other
A	Solid Wall
B	Tower
N	None

# Ohio Bridge Inventory Guide

## Ohio Item 535 – Pier 1 (Predominate) Material

Code the predominate material of pier using the table below, if pier is present. If there are no piers code “**N**” for none.

<u>Code</u>	<u>Material</u>
1	Stone
2	Concrete
3	Concrete and Stone
4	Timber
5	Steel
6	Steel and Timber
7	Steel and Concrete
N	None
0	Other

## Ohio Item 536 – Pier 1 Type - Foundation Type

Code the type of foundation for the pier. If there are no piers code “**N**” for none. For three sided precast concrete structures, code as spread footings or pile type foundation accordingly. For four-sided boxes code foundations as “**N**” for none.

<u>Code</u>	<u>Type</u>
1	Steel H Piles (Other size)
2	Cast-in-Place Reinforced Concrete Piles (Other diameter)
3	Drilled Shafts
4	Spread Footing
5	Timber Piles
6	Rock
7	Steel H Piles (HP 10 x 42)
8	Steel H Piles (HP 12 x 53)
9	Steel H Piles (HP 14 x 73)
0	Other
U	Unknown (Older Bridge being added to the file and foundations are unknown)
N	None (such as most Culverts) (Code all N's)
A	Cast-in-Place Reinforced Concrete Piles (12" diameter)
B	Cast-in-Place Reinforced Concrete Piles (14" diameter)
C	Cast-in-Place Reinforced Concrete Piles (16" diameter)

This item **must** be coded for all structures.

## Ohio Item 537 – Pier 2 Type

If more than one type of pier present, code the second most predominate type of pier using the table below.

<u>Code</u>	<u>Type</u>
1	Gravity

## Ohio Bridge Inventory Guide

---

2	Cantilever (Tee) Open Panel
3	Cantilever (Tee) Solid Panel
4	Open Column
5	Capped Column
8	Capped Pile
0	Other
A	Solid Wall
B	Tower
N	None

### Ohio Item 538 – Pier 2 Material

Code the predominate material of pier type 2 using the table below.

<u>Code</u>	<u>Material</u>
1	Stone
2	Concrete
3	Concrete and Stone
4	Timber
5	Steel
6	Steel and Timber
7	Steel and Concrete
N	None
0	Other

### Ohio Item 539 – Pier 2 Type - Foundation Type

Code the type of foundation for the pier type 2. If there are no piers code “N” for none. For three (3) - sided precast concrete structures, code as spread footings (Code 4) or pile type foundation accordingly.

***Four (4) -sided boxes should have the foundations coded “N” for none.***

<u>Code</u>	<u>Type</u>
1	Steel H Piles (Other size)
2	Cast-in-Place Reinforced Concrete Piles (Other diameter)
3	Drilled Shafts
4	Spread Footing
5	Timber Piles
6	Rock
7	Steel H Piles (HP 10 x 42)
8	Steel H Piles (HP 12 x 53)
9	Steel H Piles (HP 14 x 73)
0	Other
U	Unknown (Older Bridge being added to the file and foundations are unknown)
N	None (such as most Culverts) (Code all N's)
A	Cast-in-Place Reinforced Concrete Piles (12" diameter)
B	Cast-in-Place Reinforced Concrete Piles (14" diameter)

# Ohio Bridge Inventory Guide

---

C	Cast-in-Place Reinforced Concrete Piles (16" diameter)
---	--

This item must be coded for all structures, if applicable.

## Ohio Item 547 – Slope Protection Type

Code the Slope Protection type from the table. Natural protection (grass, bushes, trees) are to be coded N. If channel extends all the way to the abutments, there is no slope protection. The dominant slope protection must be coded for all structures.

<u>Code</u>	<u>Description</u>
1	Concrete (cast-in-place)
2	Stone (No. 1 Aggregate)
3	Rip Rap (dumped rock or rock channel protection)
4	Gabions (wire mesh baskets filled with stone)
5	Fabric bags filled with concrete
0	Other
A	Reinforced Cast-In-Place Concrete Wall
B	Soldier Pier and Lagging Wall
C	Mechanically Stabilized Earth (MSE) Wall
D	Soil Nail Wall
E	Tie Back Wall
F	Sheet Pile Wall
G	Cribbed Wall
H	Concrete Block Wall
I	Stone Wall
S	Soil
N	None

## Ohio Item 575 – Culvert Type

If the structure is coded as a culvert, then this item must reflect the appropriate code from the following table. For a combination of more than one (1) type, code the most appropriate type under the pavement. If the structure is not a culvert, Code N.

<u>Code</u>	<u>Description</u>
1	Slab Top
2	4-Sided Box (Concrete Cast-In-Place), structure material type must be coded as "1"
3	3-Sided Frame (Concrete Cast-In-Place), structure material type must be coded as "1"
4	Pipe-Circular
5	Pipe-Arch (also includes stone)
6	Pipe-Elliptical
7	Arch (Multi-Plate)
8	4-Sided Box (Concrete Precast), structure material type must be coded as "1"
9	3-Sided Frame (Concrete Precast), structure material type must be coded as "1"

# Ohio Bridge Inventory Guide

---

O	Other
A	4-Sided Box (Aluminum)
B	4-Sided Box (Other)
C	3-Sided Frame (Aluminum)
D	Conspan (Concrete pre-cast)
E	Bebo-type (Concrete pre-cast)
F	Metal Arch on concrete pedestal wall & footing
N	Not a Culvert or Rigid Frame

## Ohio Item 578 – Culvert Pipe Length (Inlet – Outlet)

This item shall be used to record the out/out length of culvert type bridges. The length shall be measured along the axis from inlet to outlet at invert. If there is a bend or curve along the length, measure the length along the bend or the curve.

This item must be recorded for all structure types coded as culverts. For all other structure types, leave this item blank.

**Length Out/Out of Culvert is measured differently than NBI Item 49 Structure Length.**

## Ohio Item 580 – Fill Depth over Culvert

Code the depth of fill over a culvert in feet. If depth of fill exceeds 99' code 99. If bridge type is not a culvert, leave this item blank.

The depth of fill should be measured from the top of the structure to the top of the pavement. Do not subtract for the depth of the pavement. If the depth of fill over the structure varies, measure the depth of fill at the center of the structure at centerline of the paved surface on the structure.

This item must be coded for all filled culverts.

## Ohio Item 587 – Rise

Code the rise of culvert in inches.

## Ohio Item 588 – Shape

Code the general shape of culvert from the table.

<u>Code</u>	<u>Description</u>
01	Circular
02	Elliptical - Horizontal
03	Elliptical - Vertical
04	Pipe Arch
05	Pipe Arch, Sect. Plate
06	Arch
07	Box Culvert

# Ohio Bridge Inventory Guide

---

08	Slab Top Culvert
99	Other

## Ohio Item 651 – Scenic River

Code Y or N if the waterway is classified as a Scenic River. If there is no waterway under, leave blank.

## Ohio Item 655 – Channel Protection Type

Enter the appropriate code from the following table indicating the channel protection type used.

<u>Code</u>	<u>Description</u>
1	Concrete (cast-in-place)
2	Stone
3	Sheet Piling
4	Piling
5	Rip Rap (dumped rock or rock channel protection)
6	Gabions (wire mesh baskets filled with stone)
7	Fabric bags filled with concrete or sand
N	None
0	Other
X	Not Applicable
A	Precast concrete (panels)
B	Earthen Dikes
U	Unknown

## Ohio Item 663 – Stream Velocity

Record hundred-year velocity of the stream under the bridge. This figure is generally found on the “Site Plan” of the “Bridge Design Plans”. If not applicable, leave it blank.

## Ohio Item 672 – pH value

Code the pH value if there is a stream under the bridge. Leave it blank otherwise.

## Ohio Item 704 – Load Rating Date

***This item must be coded.***

Code the date when the structure was last load rated. If the bridge is closed, code year closed.

## Ohio Item 705 – Load Rater First Name

Code the first name of the load rater for the bridge.



# Ohio Bridge Inventory Guide

---

## Ohio Item 706 – Load Rater Last Name

Code the last name of the load rater of the bridge.

## Ohio Item 707 – Load Rater Ohio PE Number

Code the Rating Engineer’s Ohio PE Number using a leading zero.

## Ohio Item 708 – Load Rating Software

Code this item per the appropriate description from the table. This item must be coded for all highway bridges.

<u>Code</u>	<u>Description</u>
1	BARS
2	BRASS
3	AASHTO BrR (VIRTIS)
4	Testing
5	Finite Element (FE) Program
6	In-House Program/Spreadsheet
7	Combination
8	Other program
9	Manual Calculations
0	Assigned rating (no calculations were done)

## Ohio Item 709 – Rating Source

This item indicates if design plans were sufficient to do a load rating. If plan is only a site plan or construction layout sketch, etc., then this item should be coded as “0 - No plans available” since there is not enough information on the plans to do a load rating.

<u>Code</u>	<u>Description</u>
0	No Plans or information available for load rating analysis
1	Plan information available for load rating analysis (Default)
2	Field measured information for load rating analysis
3	Field testing information
N	Not Applicable

## Ohio Item 711 – Live Load Response

Code the Live Load Response based on the following table for highway bridges. Leave blank for all other bridges.

S – Satisfactory
E – Excessive
Blank

## Ohio Item 717 – 2F1 Operating Rating Factor GVW 15 T)

This item must be coded for bridges carrying highway.

# Ohio Bridge Inventory Guide

---

Code the appropriate rating factor in the format X.XXX.

## **Ohio Item 720 – 3F1 Operating Rating Factor (GVW 23 T)**

This item must be coded for bridges carrying highway.

Code the appropriate rating factor in the format X.XXX.

## **Ohio Item 723.01 – 4F1 Operating Rating Factor (GVW 27 T)**

This item must be coded for bridges carrying highway.

Code the appropriate rating factor in the format X.XXX.

## **Ohio Item 723.02 – SU4 Operating Rating Factor (GVW 27 T)**

This item must be coded for bridges carrying highway.

Code the appropriate rating factor in the format X.XXX.

## **Ohio Item 726.01 – 5C1 Operating Rating Factor (GVW 40 T)**

This item must be coded for bridges carrying highway.

Code the appropriate rating factor in the format X.XXX.

## **Ohio Item 726.02 – SU5 Operating Rating Factor (GVW 31 T)**

This item must be coded for bridges carrying highway.

Code the appropriate rating factor in the format X.XXX.

## **Ohio Item 732.01 – SU6 Operating Rating Factor (GVW 34.75 T)**

This item must be coded for bridges carrying highway.

Code the appropriate rating factor in the format X.XXX.

## **Ohio Item 732.02 – SU7 Operating Rating Factor (GVW 38.75 T)**

This item must be coded for bridges carrying highway.

Code the appropriate rating factor in the format X.XXX.

## **Ohio Item 734 – Ohio Percent Legal**

This item must be coded for bridges carrying highways.

Enter the calculated or estimated percent of Ohio Legal Loads. Code the figures to the nearest 5 percent. If the structure carries other than public motor vehicular traffic (e.g., railroad, pedestrian walk, pipe line, taxiway, etc.) or if structure is closed, when this item does not apply,, code all zeros.

<b><u>Example</u></b>	<b><u>Code</u></b>
125%	125
65%	065
For structures rated at greater than 150% of Legal Load	150

# Ohio Bridge Inventory Guide

---

## [Ohio Item 735 – EV2 Operating Rating Factor \(GVW 28.75 T\)](#)

This item must be coded for bridges carrying highway.

Code the appropriate rating factor in the format X.XXX.

## [Ohio Item 738 – EV3 Operating Rating Factor \(GVW 43 T\)](#)

This item must be coded for bridges carrying highway.

Code the appropriate rating factor in the format X.XXX.

## [Ohio Item 825 – Historical Bridge Name](#)

This Item is on Historical Bridge Data page. Code the Historical Bridge Name, if any.

## [Ohio Item 826 – NR Recommendation](#)

This item is on Historical Bridge data page. This item refers to the eligibility recommendation from the Nation Register (NR) of Historical Places. This Item has following categories:

<u>Code</u>	<u>Description</u>
1	NR Listed
2	Eligible
4	Further Research
5	Not Eligible

## [Ohio Item 831 – Historical Builder](#)

This Item is on the Historical Bridge Data page. Code the builder as identifies in the historical records.

	<u>Description</u>
<u>000</u>	<u>NONE N/A</u>
<u>001</u>	<u>A. W. ZESIGER (ASS'T PARK COMMISSIONER)</u>
<u>002</u>	<u>ABRAHAM SLONAKER</u>
<u>003</u>	<u>AKINS BRIDGE</u>
<u>004</u>	<u>ALFRED M. FELGATE COUNTY ENGINEER</u>
<u>005</u>	<u>AMERICAN BRIDGE CO</u>
<u>006</u>	<u>AMERICAN CULVERT CO</u>
<u>007</u>	<u>AMERICAN-MARIETTA CO.</u>
<u>008</u>	<u>ANDERSON GREEN CO.</u>
<u>009</u>	<u>ATLAS ENGINEERING, INC.</u>
010	B & O RAILROAD
011	BELLEFONTAINE BRIDGE & STEEL CO
012	BENTLEY, A. AND SONS (OTTAWA BRIDGE COMP
013	BERG, J. CONTRACTOR
014	BERLIN BRIDGE COMPANY
015	BETHLEHEM STEEL COMPANY
016	BIEDINGER, J.R.

## Ohio Bridge Inventory Guide

---

017	BLODGETT, Z. AND POLLUCK, H.D.
018	BLOGETT, ZOPHER
019	BOREBO IRON COMPANY
020	BOULTON GRANT COMPANY
021	BRACKETT BRIDGE CO (CINCINNATI, OH)
022	BREWER, BREWER AND SONS
023	BROCK, GEORGE AND SON
024	BRODE, W. M. AND COMPANY
025	BROOKVILLE BRIDGE CO
026	BROWN, LOUIS
027	BUCHANAN BRIDGE CO (BELLEFONTAINE, OH)
028	BUCKEYE BRIDGE BUILDER (WORKS) (BUILDERS
029	BURGER IRON CO (AKRON)
030	C.A. BAKER AND MIDLAND CONST. CO.
031	C. M. RUSSELL & CO
032	CAMBRIDGE BRIDGE CO
033	CANTON BRIDGE CO
034	CAPITOL CONSTRUCTION CO (COLUMBUS, OH)
035	CARMICHAEL CRYDER CO.
036	CARNAHEN, JOHN
037	CARPENTER & BLANK (TROY, OH)
038	CASE CRANE AND ENGINEER COMPANY
039	CENTRAL CONSTRUCTION CO
040	CENTRAL STATE BRIDGE CO (INDIANAPOLIS, I
041	CHAMBERLAIN, B.C.
042	CHAMPION BRIDGE CO (WILMINGTON, OH)
043	CHARLES F. SCHWEINFURTH
044	CHARLES ROBERTS & WANDER AND MASON, INC.
045	CHICAGO BRIDGE COMPANY
046	CINCINNATI DEPT OF PUBLIC WORKS
047	CINCINNATI LEBANON & NORTHERN RR
048	CINCINNATI BRIDGE COMPANY
049	CITY OF COLUMBUS/GENERAL ASPHALT PAVING
050	CLEVELAND IRON BRIDGE CO
051	CLEVELAND, N. W.
052	CLYDE T MORRIS/BELLEFONTAINE BRIDGE & STE
053	COHAINS-GIRKINS, CONTRACTOR
054	COLUMBIA BRIDGE COMPANY (COLUMBIA BRIDGE)
055	COLUMBIA BRIDGE WORKS (DAYTON, OH)
056	COLUMBUS BRIDGE COMPANY
057	CONCRETE FABRICATORS, INC.
058	CONCRETE-STEEL ENGINEERING CO (NEW YORK)
059	CORPS OF ENGINEERS
060	COSHOCTON IRON WORKS
061	COUNTY ENGINEER
062	CROGHAN CONSTRUCTION CO (FREMONT, OH)

## Ohio Bridge Inventory Guide

---

063	CURTIS C. LATTIMER
064	DAN BENNETT
065	DANIEL FULTON
066	DAVID H. MORRISON
067	DECKER & SON, KENTON, OH
068	DELAWARE BRIDGE AND IRON COMPANY
069	DANCY, MCCURDY & CO.
070	DETROIT BRIDGE AND IRON WORKS
071	DILTZ & STEELE
072	DRUMM, E. O.
073	E B HENDERSON
074	E. A. GAST
075	E. F. GATES
076	E. M. GEPHART AND R. C. KLINE
077	EAST IRON AND MACHINE COMPANY
078	EDWARDS BRIDGE COMPANY
079	EDWARDS SHEET METAL WORKS, INC.
080	ELFOR, E. CONTRACTORS
081	ELKHART BRIDGE AND IRON COMPANY
082	EVANS, ROBERT H. AND COMPANY
083	EVERETT S. SHERMAN
084	F. K VAUGHN BLDG. COMPANY
085	F. L GORMAN
086	FEDERAL WORKS AGENCY
087	FOLEY
088	FORT PITT BRIDGE COMPANY
089	FOUTS & TOWNSEND
090	FOX, AL S. AND COMPANY
091	FUSH, C.
092	'G. W. PILCHER
093	'G. W. DOERZBACH
094	GEO W. TIMMONS COMPANY
095	GEORGE A. TAYLOR/NEWTON-BAXTER CO
096	GERAUX BROS. CO. – CONTRACTORS
097	GOTTLIEB BUNZ
098	GREAT LAKES STRUCTURAL CONCRETE PRODUCTS
099	'H. C. PETTIBONE (ASHVILLE, OH)
100	HANLY & YOUNG/FOLEY
101	HANNEMAN BROTHERS
102	HARDIN CO. ENGINEER HAROLD E. REMSBURG
103	HAROLD DECKER & SON
104	HARRINGTON HOWARD & ASH/PRICE BROS
105	HENRY E. HEBBLE
106	HEKING BRIDGE COMPANY – ASHTABULA BRIDGE
107	HEPBURN, H. B.
108	HERGE, FRANK INC.

## Ohio Bridge Inventory Guide

---

109	HEVETH CONSTRUCTION
110	HIGHWAY CONSTRUCTION COMPANY
111	HIRAM DENNISON
112	HOCKING VALLEY BRIDGE WORKS
113	HOME ENGINEERING & CONTRACTING CO
114	HOSTLER, W. S.
115	HOUSTON – CLEVELAND BRIDGE COMPANY
116	HOWARD NEEDLES TAMMEN & BERGENDOFF
117	HUNT, R. C.
118	HUSTON & CLEVELAND CONTRACTORS
119	'I. M HELLER CO.
120	IDEAL CONSTRUCTION COMPANY
121	INDIANA BRIDGE CO (MUNCIE, IND.)
122	INDIANAPOLIS BRIDGE COMPANY
123	INDIANAPOLIS FROG & SWITCH CO (SPRINGFIE
124	INTERNATIONAL DERRICK AND EQUIPMENT
125	INTERSTATE BUILDING CO
126	IRON SUBSTRUCTURE COMPANY
127	J C BROWN
128	J C DAVIS
129	'J. ROBERT BIEDINGER, CITY ENGINEER
130	JACOB R BRANDT
131	JAMES ARNOLD
132	JEREMIAH C. MOUNTZ
133	JIM FARLEY
134	JOHN A ROEBLING
135	JOHN CARNAHAN
136	JOHN SHRAKE
137	JOHN SMOLEN, COUNTY ENGINEER
138	JONES AND LAUGHLIN STEEL
139	JONES BRITHERS STRUCTURAL STEEL COMPANY
140	JOSEPH DAVENPORT
141	JOSIAH SPAULDING
142	KELL – ATKINSON CONSTRUCTION COMPANY
143	KELLOGG & MAURICE BRIDGE WORKS (ATHENS,
144	KEYSTONE BRIDGE COMPANY
145	KING BRIDGE COMPANY
146	KIRCHNER CONSTRUCTION COMPANY
147	KNOXVILLE BRIDGE COMPANY
148	LACKAWANA STEEL CONSTRUCTION COMPANY
149	LANE BROTHERS BRIDGE AND CONSTRUCTION CO
150	LANFERSIECK AND GROTHAUS
151	LATHAM E. M. COMPANY
152	LOMAS FORGE & BRIDGE WORKS (CINCINNATI)
153	LOUISVILLE & NASHVILLE RR
154	LUCAS COUNTY

## Ohio Bridge Inventory Guide

---

155	LUTEN BRIDGE COMPANY (YORK, PA)
156	M. COLLINS
157	MACDOUGALD CONSTRUCTION
158	MAHON, R. C. COMPANY
159	MARIETTA & CINCINNATI RR/(PETER) YOUNG
160	MARION BRIDGE COMPANY
161	MARTIN MCGRATH & LYMAN WELLS
162	MASSILLON BRIDGE COMPANY
163	MAXON CONSTRUCTION COMPANY
164	MCCLINTIC – MARSHALL COMPANY
165	MELAN ARCH CONSTRUCTION COMPANY OF NEW Y
166	MERYDITH CONSTRUCTION CO (CHAMBERSBURG,
167	MIAMI & ERIE CANAL
168	MIAMI CONSERVANCY DISTRICT
169	MIAMI COUNTY ENGINEERS OFFICE
170	MIDLAND CONSTRUCTION
171	MILLER – TAYLOR CONSTRUCTION COMPANY
172	MILLER JAMISON AND COMPANY
173	MILWAUKEE BRIDGE AND IRON WORKS
174	MODERN CONSTRUCTION COMPANY
175	MONTGOMERY CO. DEPT OF ROADS BRIDGES AND
176	MORGAN ENGINEER COMPANY
177	MORSE BRIDGE COMPANY
178	MOSES WEYMOUTH
179	MOTHERWELL IRON AND STEEL COMPANY
180	MT VERNON BRIDGE COMPANY
181	N.R. PORTERFIELD INC.
182	NELSON-MERYDITH CO (CHAMBERSBURG, PA)
183	NEW BREMEN BRIDGE CO (NEW BREMEN, OH)
184	NEW CASTLE BRIDGE COMPANY
185	NEW COLUMBUS BRIDGE CO (COLUMBUS, OH)
186	NEWTON – BAXTER COMPANY
187	NOBLE CONSTRUCTION COMPANY
188	OHIO & ERIE CANAL
189	OHIO BRIDGE COMMISSION
190	OHIO BRIDGE CORP
191	OHIO CORRUGATED CULVERT COMPANY (SUPPLIE
192	OHIO STATE HIGHWAY DEPARTMENT
193	OHIO STEEL ERECTION COMPANY
194	OREGONIA BRIDGE CO (LEBANON, OH)
195	ORLISTUS ROBERTS & LYMAN CAMPBELL
196	OSBORN ENGINEERING COMPANY
197	P.O. MONFORT EMERSON & JONES
198	PAN AMERICAN BRIDGE COMPANY
199	PANDORA CEMENT BLOCK COMPANY
200	PENN BRIDGE WORKS (T. B. WHITE & SONS -

## Ohio Bridge Inventory Guide

---

201	PENNSYLVANIA RR
202	PERKINS BRIDGE & SUPPLY COMPANY
203	PETER SCHISLER; GUY TILDEN – ARCHITECT
204	PITTSBURGH-DES MOINES STEEL CO
205	PITTSBURGH CONSTRUCTION COMPANY
206	POTTER
207	PRESCON, INC.
208	PUBLIC WORKS ADMINISTRATION
209	QUEEN CITY BRIDGE CO (CINCINNATI OH)
210	R H MCCRACKEN
211	RAILROAD
212	RIVERSIDE BRIDGE COMPANY (MARTINS FERRY,
213	ROBERTS SUPPLY COMPANY
214	ROCHESTER BRIDGE COMPANY
215	ROGERS IRON CO
216	ROLLA MERYDITH
217	ROSS RULE
218	REUBEN L PARTRIDGE
219	SAMUEL PRICE
220	SCHERZER ROLLING LIFT C. H. FATH & SON
221	SCULLY, E. M.
222	SMITH BRIDGE CO (TOLEDO, OH)
223	SMITH LATROBE & CO
224	SMITH W. W.
225	SOUTH BRIDGE COMPANY
226	STANDARD DRAWING-BRIDGE BUREAU
227	STANDARD ENGINEERING CO
228	STATE FORCES
229	STEUBENVILLE-WEIRTON BRIDGE CO DRAVO COR
230	SUNBURY MFG COMPANY
231	SWINGLE, (J.A.) CONTRACTING COMPANY AND
232	T.H. WATSON-CONSTRUCTION & AND BUILDING
233	TOLEDO BRIDGE & CRANE CO
234	TOLEDO MASSILLON BRIDGE CO
235	US ARMY NATIONAL GUARD
236	V. C. BERG STONE CO
237	VARIETY IRON WORKS (CLEVELAND, OH)
238	VINCENNES STEEL CORP.
239	W. H. BAKER
240	'W. H. PRATT/BUCKEYE PORTLAND CEMENT
241	W. M. BRODE & CO.
242	WORKS PROJECT ADMINISTRATION
243	WADDELL & HARDESTY/MCLINTIC-MARSHALL CO
244	WAGNER, HOWERY AND MANIX
245	WALTER P. RICE
246	WALSH CONSTRUCTION CO., DAVENPORT, IOWA



## Ohio Bridge Inventory Guide

---

247	WEST VIRGINIA BRIDGE WORKS
248	WHEELING STRUCTURAL COMPANY
249	WILBUR WATSON & ASSOCIATES
250	WILEY CONSTRUCTION COMPANY
251	WILLIAM G. MCHUGH COMPANY
252	WILLIAM LUCAS, CITY ENGINEER
253	WM A DEAN
254	WM THOMPSON
255	WREN REESE, INC./AMERICAN-MARIETTA CO. (
256	WROUGHT IRON BRIDGE CO (CANTON, OHIO)
257	WYNKOOP AND MCGORMLEY COMPANY
258	YORK BRIDGE COMPANY (YORK, PA)
259	YOUNGSTOWN BRIDGE COMPANY
260	ZENAS KING
261	ZIMRI WALL
262	LOEW MANUFACTURER COMPANY
263	ADAMS BROTHERS
264	ATLAS ENGINEERING INC.
265	CHAMPION IRON CO (KENTON, OH)
266	CITY
267	CLEVELAND CINCINNATI CHICAGO&ST LOUIS RR
268	COUNTY
269	DE LEUW CATHER AND COMPANY
270	ERIE RR
271	GUY TILDEN, ARCHITECT
272	J E GREINER COMPANY (BALTIMORE, MD)
273	J S SMALL
274	J W O'BRIEN & D. S. DESEMBERG
275	KERPEN CONSTRUCTION COMPANY
276	MCGORMLEY
277	NEW YORK CENTRAL
278	ROANOKE, VA
279	SAMUEL S. TAYLOR
280	UNION TERMINAL COMPANY
281	WABASH & ERIE CANAL
282	WENDELL BROWN DESIGNER MARVIN BROWN ARCH
283	BRAUN, FLEMING, KNOLLMAN
284	CCC
285	ODOT
286	T.L. WILSON
287	JOHN C. GREGG
999	UNKNOWN

# Ohio Bridge Inventory Guide

---

## Under Records

An Under Record represents information about a route under the bridge, other than an Inventory Route. Following Items must be repeated for each Under Record.

Item Number	Description
NBI 1	State Code
NBI 5A	Under Route: Record Type
NBI 5B	Under Route: Route Signing Prefix
NBI 5C	Under Route: Designated Level of Service
NBI 5D	Under Route: Route Number
NBI 5E	Under Route: Direction Suffix
NBI 6	Feature Intersected
NBI 7	Facility Carried by Structure
NBI 8	Structure Number
NBI 10	Practical Maximum Vertical Clearance Under Route
NBI 11	Milepoint of Under Route
NBI 12	Base Highway Network
NBI 13A	Linear Reference System (LRS) - Route
NBI 13B	Linear Reference System (LRS) - Subroute
NBI 19	Bypass Detour Length
NBI 20	Toll
NBI 26	Functional Classification of Route
NBI 29	Average Daily Traffic (ADT)
NBI 30	Year of ADT
NBI 47	Total Horizontal Clearance Under Route
NBI 100	STRAHNET Highway Designation
NBI 101	Parallel Structure Designation
NBI 102	Direction of Traffic
NBI 104	Highway System of the Under Route (NHS)
NBI 109	Average Daily Truck Traffic Under Route
NBI 110	Designated National Network of Under Route
Ohio Item 201	Special Designation
Ohio Item 206	Preferred Under Route
Ohio Item 213	NLF_ID Under Route
Ohio Item 335A	Minimum Horizontal Clearance - Cardinal Under Route
Ohio Item 335B	Minimum Horizontal Clearance - Non-Cardinal Under Route
Ohio Item 336A	Minimum Vertical Clearance - Cardinal Under Route
Ohio Item 336B	Minimum Vertical Clearance - Non-Cardinal Under Route
Ohio Item 381	Daily Truck Traffic Under Route

# Ohio Bridge Inventory Guide

---

## APPENDIX A – Ohio Counties

### Alphabetic Codes, County Number, ODOT District, FIPS Code

<u>COUNTY</u>	<u>COUNTY NO</u>	<u>ALPHABETIC CODE</u>	<u>DISTRICT</u>	<u>FIPS CODE</u>
Adams	01	ADA	09	01
Allen	02	ALL	01	03
Ashland	03	ASD	03	05
Ashtabula	04	ASH	04	07
Athens	05	ATH	10	09
Auglaize	06	AUG	07	11
Belmont	07	BEL	11	13
Brown	08	BRO	09	15
Butler	09	BUT	08	17
Carroll	10	CAR	11	19
Champaign	11	CHP	07	21
Clark	12	CLA	07	23
Clermont	13	CLE	08	25
Clinton	14	CLI	08	27
Columbiana	15	COL	11	29
Coshocton	16	COS	05	31
Crawford	17	CRA	03	33
Cuyahoga	18	CUY	12	35
Darke	19	DAR	07	37
Defiance	20	DEF	01	39
Delaware	21	DEL	06	41
Erie	22	ERI	03	43
Fairfield	23	FAI	05	45
Fayette	24	FAY	06	47
Franklin	25	FRA	06	49
Fulton	26	FUL	02	51
Gallia	27	GAL	10	53
Geauga	28	GEA	12	55
Greene	29	GRE	08	57
Guernsey	30	GUE	05	59
Hamilton	31	HAM	08	61
Hancock	32	HAN	01	63
Hardin	33	HAR	01	65
Harrison	34	HAS	11	67
Henry	35	HEN	02	69

## Ohio Bridge Inventory Guide

---

<u>COUNTY</u>	<u>COUNTY NO</u>	<u>ALPHABETIC CODE</u>	<u>DISTRICT</u>	<u>FIPS CODE</u>
Highland	36	HIG	09	71
Hocking	37	HOC	10	73
Holmes	38	HOL	11	75
Huron	39	HUR	03	77
Jackson	40	JAC	09	79
Jefferson	41	JEF	11	81
Knox	42	KNO	05	83
Lake	43	LAK	12	85
Lawrence	44	LAW	09	87
Licking	45	LIC	05	89
Logan	46	LOG	07	91
Lorain	47	LOR	03	93
Lucas	48	LUC	02	95
Madison	49	MAD	06	97
Mahoning	50	MAH	04	99
Marion	51	MAR	06	101
Medina	52	MED	03	103
Meigs	53	MEG	10	105
Mercer	54	MER	07	107
Miami	55	MIA	07	109
Monroe	56	MOE	10	111
Montgomery	57	MOT	07	113
Morgan	58	MOR	10	115
Morrow	59	MRW	06	117
Muskingum	60	MUS	05	119
Noble	61	NOB	10	121
Ottawa	62	OTT	02	123
Paulding	63	PAU	01	125
Perry	64	PER	05	127
Pickaway	65	PIC	06	129
Pike	66	PIK	09	131
Portage	67	POR	04	133
Preble	68	PRE	08	135
Putnam	69	PUT	01	137
Richland	70	RIC	03	139

## Ohio Bridge Inventory Guide

---

<b>COUNTY</b>	<b>COUNTY NO</b>	<b>ALPHABETIC CODE</b>	<b>DISTRICT</b>	<b>FIPS CODE</b>
Ross	71	ROS	09	141
Sandusky	72	SAN	02	143
Scioto	73	SCI	09	145
Seneca	74	SEN	02	147
Shelby	75	SHE	07	149
Stark	76	STA	04	151
Summit	77	SUM	04	153
Trumbull	78	TRU	11	155
Tuscarawas	79	TUS	11	157
Union	80	UNI	06	159
Van Wert	81	VAN	01	161
Vinton	82	VIN	10	163
Warren	83	WAR	08	165
Washington	84	WAS	10	167
Wayne	85	WAY	03	169
Williams	86	WIL	02	171
Wood	87	WOO	02	173
Wyandot	88	WYA	01	175

# Ohio Bridge Inventory Guide

---

## APPENDIX B – NBI #4 Place Codes (FIPS)

### ADAMS COUNTY

<u>City/Twp.</u>	<u>FIPS</u>	<u>City/Twp.</u>	<u>FIPS</u>	<u>City/Twp.</u>	<u>FIPS</u>
Cherry Fork	13834	Manchester	47012	Peebles	61420
Rome	68196	Seaman	71206	West Union	84294
Winchester	85876	Bratton Twp.	08350	Brush Creek Twp.	09722
Franklin Twp.	28196	Green Twp.	31668	Jefferson Twp.	38486
Liberty Twp.	43036	Manchester Twp.	47026	Meigs Twp.	48888
Monroe Twp.	51268	Oliver Twp.	58366	Scott Twp.	71052
Sprigg Twp.	74069	Tiffin Twp.	76768	Wayne Twp.	82012
Winchester Twp.	85890				

### ALLEN COUNTY

<u>City/Twp.</u>	<u>FIPS</u>	<u>City/Twp.</u>	<u>FIPS</u>	<u>City/Twp.</u>	<u>FIPS</u>
Beaverdam	04752	Bluffton	07426	Cairo	10884
Delphos	21602	Elida	24808	Fort Shawnee	27944
Harrod	34118	Lafayette	41118	Lima	43554
Spencerville	74034	Amanda Twp.	01602	American Twp.	01756
Auglaize Twp.	02988	Bath Twp.	04206	Jackson Twp.	37646
Marion Twp.	47656	Monroe Twp.	51282	Perry Twp.	61742
Richland Twp.	66614	Shawnee Twp.	71955	Spencer Twp.	73982
Sugar Creek Twp.	75199				

### ASHLAND COUNTY

<u>City/Twp.</u>	<u>FIPS</u>	<u>City/Twp.</u>	<u>FIPS</u>	<u>City/Twp.</u>	<u>FIPS</u>
Ashland	02568	Bailey Lakes	03562	Hayesville	34636
Jeromesville	39060	Loudonville	45066	Mifflin	50036
Perrysville	62190	Polk	63996	Savannah	70576
Clear Creek Twp.	15672	Green Twp.	31682	Hanover Twp.	33236
Jackson Twp.	37660	Lake Twp.	41272	Mifflin Twp.	50050
Milton Twp.	50610	Mohican Twp.	51086	Montgomery Twp.	51688
Orange Twp.	58562	Perry Twp.	61756	Ruggles Twp.	68966
Sullivan Twp.	75357	Troy Twp.	77532	Vermillion Twp.	795758

# Ohio Bridge Inventory Guide

## ASHTABULA COUNTY

<u>City/Twp.</u>	<u>FIPS</u>	<u>City/Twp.</u>	<u>FIPS</u>	<u>City/Twp.</u>	<u>FIPS</u>
Andover	02050	Ashtabula	02638	Conneaut	18350
Geneva	29610	Geneva On Lake	29652	Jefferson	38500
North Kingsville	56700	Orwell	58856	Roaming Shores	67600
Rock Creek	67846	Andover Twp.	02064	Ashtabula Twp.	02652
Austinburg Twp.	03156	Cherry Valley Twp.	13890	Colebrook Twp.	16560
Denmark Twp.	21672	Dorset Twp.	22344	Geneva Twp.	29624
Harpersfield Twp.	33642	Hartsgrove Twp.	34300	Jefferson Twp.	38514
Kingsville Twp.	40404	Lenox Twp.	42742	Monroe Twp.	40404
Morgan Twp.	52066	New Lyme Twp.	54964	Orwell Twp.	58870
Pierpont Twp.	62568	Plymouth Twp.	63772	Richmond Twp.	66796
Rome Twp.	68224	Saybrook Twp.	70646	Sheffield Twp.	7253
Trumbull Twp.	77686	Wayne Twp.	82040	Williamsfield Twp.	85372
Windsor Twp.	85988				

## ATHENS COUNTY

<u>City/Twp.</u>	<u>FIPS</u>	<u>City/Twp.</u>	<u>FIPS</u>	<u>City/Twp.</u>	<u>FIPS</u>
Albany	01042	Amesville	01784	Athens	02736
Buchtel	09834	Chauncey	13778	Coolville	18588
Glouster	30674	Jacksonville	38304	Nelsonville	53886
Trimble	77406	Alexander Twp.	01112	Ames Twp.	01770
Athens Twp.	02750	Bern Twp.	05942	Canaan Twp.	11220
Carthage Twp.	12336	Dover Twp.	22414	Lee Twp.	42420
Lodi Twp.	44590	Rome Twp.	68238	Trimble Twp.	77420
Troy Twp.	77546	Waterloo Twp.	81777	York Twp.	86982

## Ohio Bridge Inventory Guide

---

### AUGLAIZE COUNTY

<u>City/Twp.</u>	<u>FIPS</u>	<u>City/Twp.</u>	<u>FIPS</u>	<u>City/Twp.</u>	<u>FIPS</u>
Buckland	09974	Cridersville	19400	Minster	50918
New Bremen	54194	New Knoxville	54838	St Marys	696804
Uniopolis	78848	Wapakoneta	80766	Waynesfield	82390
Clay Twp.	15448	Duchouquet Twp.	22722	German Twp.	29848
Goshen Twp.	30954	Jackson Twp.	37674	Logan Twp.	44618
Moulton Twp.	52472	Noble Twp.	55986	Pusheta Twp.	65018
St Marys Twp.	69694	Salem Twp.	69806	Union Twp.	78204
Washington Twp.	81074	Wayne Twp.	82054		

### BELMONT COUNTY

<u>City/Twp.</u>	<u>FIPS</u>	<u>City/Twp.</u>	<u>FIPS</u>	<u>City/Twp.</u>	<u>FIPS</u>
Barnesville	03926	Bellaire	05074	Belmont	05312
Bethesda	06138	Bridgeport	08560	Brookside	09316
Fairview	26348	Flushing	27552	Holloway	35924
Martins Ferry	48104	Morristown	52346	Powhatan Point	64542
St Clairsville	69526	Shadyside	71640	Wilson	85834
Yorkville	87178	Colerain Twp.	16602	Flushing Twp.	27566
Goshen Twp.	30968	Kirkwood Twp.	40600	Mead Twp.	48580
Pease Twp.	61378	Pultney Twp.	64962	Richland Twp.	66628
Smith Twp.	72736	Somerset Twp.	72970	Union Twp.	78218
Warren Twp.	80864	Wahington Twp.	81088	Wayne Twp.	82068
Wheeling Twp.	84602	York Twp.	86996		



# Ohio Bridge Inventory Guide

---

## BROWN COUNTY

<u>City/Twp.</u>	<u>FIPS</u>	<u>City/Twp.</u>	<u>FIPS</u>	<u>City/Twp.</u>	<u>FIPS</u>
Aberdeen	00142	Fayetteville	26796	Georgetown	29778
Hamersville	32984	Higginsport	35168	Mt Orab	52906
Ripley	67272	Russellville	69316	St Martin	69666
Sardinia	70534	Byrd Twp.	10758	Clark Twp	15224
Eagle Twp.	23072	Franklin Twp.	28210	Green Twp.	31696
Huntington Twp.	36834	Jackson Twp.	37688	Jefferson Twp.	38528
Lewis Twp.	42910	Perry Twp.	61770	Pike Twp.	62596
Pleasant Twp.	63212	Scott Twp.	71066	Sterling Twp.	74559
Union Twp.	78232	Washington Twp.	81102		

## BUTLER COUNTY

<u>City/Twp.</u>	<u>FIPS</u>	<u>City/Twp.</u>	<u>FIPS</u>	<u>City/Twp.</u>	<u>FIPS</u>
College Corner	16700	Fairfield	25970	Hamilton	33012
Jacksonburg	38192	Middletown	49840	Millville	50540
Monroe	51310	New Miami	55104	Oxford	59234
Seven Mile	71444	Sharonville	71892	Somerville	72998
Trenton	77322	Fairfield Twp.	25984	Hanover Twp.	33250
Lemon Twp.	42672	Liberty Twp.	43050	Madison Twp.	46340
Milford Twp.	50162	Morgan Twp.	52080	Oxford Twp.	59241
Reily Twp.	66096	Ross Twp.	68616	Saint Clair Twp.	69498
Wayne Twp.	82082	West Chester Twp.	83150		

## CARROLL COUNTY

<u>City/Twp.</u>	<u>FIPS</u>	<u>City/Twp.</u>	<u>FIPS</u>	<u>City/Twp.</u>	<u>FIPS</u>
Carrollton	12280	Dellroy	21560	Leesville	43518
Magnolia	46844	Malvern	46998	46998	50834
Sherrodsville	72242	Augusta Twp.	03030	Brown Twp.	09400
Center Twp.	12896	East Twp.	23226	Fox Twp.	28126
Harrison Twp.	33782	Lee Twp.	42434	Loudon Twp.	45038
Monroe Twp.	51324	Orange Twp.	58576	Perry Twp.	61784
Rose Twp.	68420	Union Twp.	78260	Washington Twp.	81116

# Ohio Bridge Inventory Guide

---

## CHAMPAIGN COUNTY

<u>City/Twp.</u>	<u>FIPS</u>	<u>City/Twp.</u>	<u>FIPS</u>	<u>City/Twp.</u>	<u>FIPS</u>
Christiansburg	14296	Mechanicsburg	48706	Mutual	53480
North Lewisburg	56770	St Paris	69708	Urbana	79072
Woodstock	86478	Adams Twp.	00212	Concord Twp.	18126
Goshen Twp.	30982	Harrison Twp.	33796	Jackson Twp.	37702
Johnson Twp.	39228	Mad River Twp.	46760	Rush Twp.	69078
Salem Twp.	69820	Union Twp.	78274	Urbana Twp.	79086
Wayne Twp.	78274				

## CLARK COUNTY

<u>City/Twp.</u>	<u>FIPS</u>	<u>City/Twp.</u>	<u>FIPS</u>	<u>City/Twp.</u>	<u>FIPS</u>
Catawba	12560	Clifton	16056	Donnelsville	22288
Enon	25452	Lawrenceville	42210	N Hampton	56588
New Carlisle	54334	S Charleston	73124	S Vienna	73796
Springfield	74118	Tremont City	77308	Bethel Twp.	06054
German Twp.	29862	Green Twp.	31703	Harmony Twp.	33586
Madison Twp.	46354	Mad River Twp.	46788	Moorefield Twp.	51912
Pike Twp.	62610	Pleasant Twp.	633226	Springfield Twp.	74119
Crystal Lakes (CDP)	19596				

## CLERMONT COUNTY

<u>City/Twp.</u>	<u>FIPS</u>	<u>City/Twp.</u>	<u>FIPS</u>	<u>City/Twp.</u>	<u>FIPS</u>
Amelia	01742	Batavia	04150	Bethel	06068
Chilo	14226	Felicity	26880	Loveland	45108
Milford	50176	Moscow	52416	Neville	53956
New Richmond	55384	Newtonsville	55664	Owensville	59220
Williamsburg	85288	Batavia Twp.	04157	Franklin Twp.	28224
Goshen Twp.	31010	Jackson Twp.	37716	Miami Twp.	49322
Monroe Twp.	51338	Ohio Twp.	57960	Pierce Twp.	62540
Stonelick Twp.	74825	Tate Twp.	76155	Union Twp.	78288
Washington Twp.	81130	Wayne Twp.	82110	Williamsburg Twp.	85302

## Ohio Bridge Inventory Guide

---

### CLINTON COUNTY

<u>City/Twp.</u>	<u>FIPS</u>	<u>City/Twp.</u>	<u>FIPS</u>	<u>City/Twp.</u>	<u>FIPS</u>
Blanchester	06908	Clarksville	15406	Lynchburg	45542
Martinsville	48118	Midland	49896	New Vienna	55748
Port William	64360	Sabina	69400	Wilmington	85792
Adams Twp.	00226	Chester Twp.	13974	Clark Twp.	15238
Green Twp.	31710	Jefferson Twp.	38542	Liberty Twp.	43064
Marion Twp.	47670	Richland Twp.	66642	Union Twp.	78302
Vernon Twp.	79772	Washington Twp.	81144	Wayne Twp.	82124
Wilson Twp.	85820				

### COLUMBIANA COUNTY

<u>City/Twp.</u>	<u>FIPS</u>	<u>City/Twp.</u>	<u>FIPS</u>	<u>City/Twp.</u>	<u>FIPS</u>
Columbiana	17036	East Liverpool	23730	East Palestine	23940
Hanoverton	33306	Leetonia	42560	Lisbon	44030
Minerva	50834	New Waterford	55790	Rogers	68084
Salem	69834	Salineville	70100	Summitville	75574
Washingtonville	81732	Wellsville	82740	Butler Twp.	10562
Center Twp.	12910	Elkrun Twp.	24906	Fairfield Twp.	25998
Franklin Twp.	28238	Hanover Twp.	33264	Knox Twp.	40824
Liverpool Twp.	44226	Madison Twp.	46368	Middleton Twp.	49784
Perry Twp.	61798	Saint Clair Twp.	69512	Salem Twp.	69848
Unity Twp.	78890	Washington Twp.	81158	Wayne Twp.	82138
West Twp.	82852	Yellow Creek Twp.	86912		

## Ohio Bridge Inventory Guide

---

### COSHOCTON COUNTY

<u>City/Twp.</u>	<u>FIPS</u>	<u>City/Twp.</u>	<u>FIPS</u>	<u>City/Twp.</u>	<u>FIPS</u>
Baltic	03744	Conesville	18266	Coshocton	18868
Nellie	53816	Plainfield	63044	Warsaw	81032
West Lafayette	83608	Adams Twp.	00240	Bedford Twp.	04864
Bethlehem Twp.	06152	Clark Twp.	15266	Crawford Twp.	19218
Franklin Twp.	28252	Jackson Twp.	37730	Jefferson Twp.	38556
Keene Twp.	39634	Lafayette Twp.	41132	Linton Twp.	43960
Mill Creek Twp.	50274	Monroe Twp.	51352	Newcastle Twp.	54376
Oxford Twp.	59248	Perry Twp.	61812	Pike Twp.	62624
Tiverton Twp.	76953	Tuscarawas Twp.	77896	Virginia Twp.	80220
Washington Twp.	81172	White Eyes Twp.	84714		

### CRAWFORD COUNTY

<u>City/Twp.</u>	<u>FIPS</u>	<u>City/Twp.</u>	<u>FIPS</u>	<u>City/Twp.</u>	<u>FIPS</u>
Bucyrus	10030	Chatfield	13694	Crestline	19330
Galion	29162	New Washington	55776	N Robinson	56994
Tiro	76932	Auburn Twp.	02890	Bucyrus Twp.	10044
Chatfield Twp.	13708	Cranberry Twp.	19134	Dallas Twp.	19932
Holmes Twp.	35980	Jackson Twp.	37744	Jefferson Twp.	38570
Liberty Twp.	43078	Lykens Twp.	45500	Polk Twp.	64010
Sandusky Twp.	70366	Texas Twp.	76463	Tod Twp.	76967
Vernon Twp.	79786	Whetstone Twp.	84644		

# Ohio Bridge Inventory Guide

---

## CUYAHOGA COUNTY

<u>City/Twp.</u>	<u>FIPS</u>	<u>City/Twp.</u>	<u>FIPS</u>	<u>City/Twp.</u>	<u>FIPS</u>
Bay Village	04416	Beachwood	04500	Bedford	04878
Bedford Heights	04920	Bentleyville	05550	Berea	05690
Bratenahl	08336	Brecksville	08364	Broadview Heights	09064
Brooklyn	09246	Brooklyn Heights	09274	Brook Park	09288
Chagrin Falls	13358	Cleveland	16000	Cleveland Heights	16014
Cuyahoga Heights	19806	East Cleveland	23380	Euclid	25704
Fairview Park	26446	Garfield Heights	29428	Gates Mills	29498
Glenwillow	30632	Highland Heights	35252	Highland Hills	35255
Hunting Valley	36918	Independence	37240	Lakewood	41664
Linndale	43918	Lyndhurst	45556	Maple Heights	47306
Mayfield	48468	Mayfield Heights	48482	Middleburgh Heights	49644
Moreland Hills	52052	Newburgh Heights	54250	North Olmsted	56882
North Randall	56924	North Royalton	57008	Oakwood	57750
Olmsted Falls	58422	Orange	58604	Parma	61000
Parma Heights	61028	Pepper Pike	61686	Richmond Heights	66894
Rocky River	68056	Seven Hills	71416	Shaker Heights	71682
Solon	72928	South Euclid	73264	Strongsville	75098
University Heights	78932	Valley View	79268	Walton Hills	80738
Warrensville Heights	80990	Westlake	83622	Woodmere	86394
Chagrin Falls Twp.	13372	Olmsted Twp.	58408		

## Ohio Bridge Inventory Guide

---

### DARKE COUNTY

<u>City/Twp.</u>	<u>FIPS</u>	<u>City/Twp.</u>	<u>FIPS</u>	<u>City/Twp.</u>	<u>FIPS</u>
Ansonia	02120	Arcanum	02330	Bradford	08084
Burkettsville	10296	Castine	12504	Gettysburg	29974
Gordon	30912	Greenville	32340	Hollansburg	35896
Ithaca	37604	New Madison	54978	New Weston	55818
North Star	57064	Osgood	58912	Palestine	59598
Pitsburg	62890	Rossburg	68672	Union City	78624
Versailles	79912	Wayne Lakes	82348	Allen Twp.	01294
Brown Twp.	09414	Butler Twp.	10576	Franklin Twp.	28266
Greenville Twp.	32354	Harrison Twp.	33810	Jackson Twp.	37758
Liberty Twp.	43092	Mississinawa Twp.	50960	Monroe Twp.	51366
Neave Twp.	53732	Patterson Twp.	61168	Richland Twp.	66656
Twin Twp.	77980	Van Buren Twp.	79380	Wabash Twp.	80248
Washington Twp.	81186	Wayne Twp.	82152	York Twp.	87010

### DEFIANCE COUNTY

<u>City/Twp.</u>	<u>FIPS</u>	<u>City/Twp.</u>	<u>FIPS</u>	<u>City/Twp.</u>	<u>FIPS</u>
Defiance	21308	Hicksville	35098	Ney	55874
Sherwood	72256	Adams Twp.	00268	Defiance Twp.	21322
Delaware Twp.	21420	Farmer Twp.	26614	Hicksville Twp.	35112
Highland Twp.	35196	Mark Twp.	47852	Milford Twp.	50190
Noble Twp.	56014	Richland Twp.	66670	Tiffin Twp.	76772
Washington Twp.	81200				

# Ohio Bridge Inventory Guide

---

## DELAWARE COUNTY

---

<u>City/Twp.</u>	<u>FIPS</u>	<u>City/Twp.</u>	<u>FIPS</u>	<u>City/Twp.</u>	<u>FIPS</u>
Ashley	02582	Columbus	18000	Delaware	21434
Dublin	22694	Galena	29148	Ostrander	58940
Powell	64486	Shawnee Hills	71976	Sunbury	75602
Westerville	83342	Berkshire Twp.	05774	Berlin Twp.	05788
Brown Twp.	09428	Concord Twp.	18140	Delaware Twp.	21448
Genoa Twp.	29694	Harlem Twp.	33516	Kingston Twp.	40362
Liberty Twp.	43106	Marlboro Twp.	47908	Orange Twp.	58618
Oxford Twp.	59262	Porter Twp.	64178	Radnor Twp.	65312
Scioto Twp.	70842	Thompson Twp.	76617	Trenton Twp.	77336
Troy Twp.	77560				

## ERIE COUNTY

<u>City/Twp.</u>	<u>FIPS</u>	<u>City/Twp.</u>	<u>FIPS</u>	<u>City/Twp.</u>	<u>FIPS</u>
Bay View	04402	Bellevue	05228	Berlin Heights	05900
Castalia	12476	Huron	37016	Kelleys Island	39662
Milan	50134	Sandusky	70380	Vermilion	79716
Berlin Twp.	05802	Florence Twp.	27482	Groton Twp.	32578
Huron Twp.	37030	Margaretta Twp.	47572	Milan Twp.	50148
Oxford Twp.	59276	Perkins Twp.	61714	Vermilion Twp.	79730

# Ohio Bridge Inventory Guide

---

## FAIRFIELD COUNTY

---

<u>City/Twp.</u>	<u>FIPS</u>	<u>City/Twp.</u>	<u>FIPS</u>	<u>City/Twp.</u>	<u>FIPS</u>
Amanda	01630	Baltimore	03758	Bremen	08392
Buckeye Lake	09890	Canal Winchester	11332	Carroll	12252
Columbus	18000	Lancaster	41720	Lithopolis	44086
Millersport	50400	Pickerington	62498	Pleasantville	63716
Reynoldsburg	66390	Rushville	69204	Stoutsville	74916
Sugar Grove	75252	Thurston	76764	West Rushville	84182
Amanda Twp.	01637	Berne Twp.	05956	Bloom Twp.	06950
Clear Creek Twp.	15686	Greenfield Twp.	32060	Hocking Twp.	35812
Liberty Twp.	43120	Madison Twp.	46382	Pleasant Twp.	63240
Richland Twp.	66684	Rush Creek Twp.	69120	Violet Twp.	80206
Walnut Twp.	80570				

## FAYETTE COUNTY

<u>City/Twp.</u>	<u>FIPS</u>	<u>City/Twp.</u>	<u>FIPS</u>	<u>City/Twp.</u>	<u>FIPS</u>
Bloomingsburg	07188	Jeffersonville	38920	Milledgeville	50316
New Holland	54726	Octa	57918	Washington CH	81214
Concord Twp.	18154	Green Twp.	31724	Jasper Twp.	383888
Jefferson Twp.	38598	Madison Twp.	46396	Marion Twp.	47684
Paint Twp.	59486	Perry Twp.	61826	Union Twp.	78316
Wayne Twp.	82166				



## Ohio Bridge Inventory Guide

---

### FRANKLIN COUNTY

<u>City/Twp.</u>	<u>FIPS</u>	<u>City/Twp.</u>	<u>FIPS</u>	<u>City/Twp.</u>	<u>FIPS</u>
Bexley	06278	Brice	08532	Canal Winchester	11332
Columbus	18000	Dublin	22694	Gahanna	29106
Grandview Hts	31304	Grove city	32592	Groveport	32606
Harrisburg	3340	Hilliard	35476	Lithopolis	44086
Lockbourne	44310	Marble Cliff	47474	Minerva Park	50862
New Albany	53970	Obetz	57862	Pickerington	62498
Reynoldsburg	66390	Riverlea	67440	Upper Arlington	79002
Urbancrest	79100	Valleyview	79282	Westerville	83342
Whitehall	84742	Worthington	86604	Blendon Twp	06922
Brown Twp	09442	Clinton Twp	16112	Franklin Twp	28280
Hamilton Twp	33026	Jackson Twp	37772	Jefferson Twp	38612
Madison Twp	37772	Mifflin Twp	50064	Norwich Twp	57344
Perry Twp	61840	Plain Twp	62974	Pleasant Twp	63254
Prairie Twp	64570	Sharon Twp	71787	Truro Twp	77714
Washington Twp	81242				

### FULTON COUNTY

<u>City/Twp.</u>	<u>FIPS</u>	<u>City/Twp.</u>	<u>FIPS</u>	<u>City/Twp.</u>	<u>FIPS</u>
Archbold	02344	Delta	21616	Fayette	26768
Lyons	45626	Metamora	49238	Swanton	75896
Wauseon	81928	Amboy Twp	01728	Chesterfield Twp	14072
Clinton Twp	16126	Dover Twp	22442	Franklin Twp	28294
Fulton Twp.	29036	German Twp.	29876	Gorham Twp.	30940
Pike Twp.	62638	Royalton Twp.	68896	Swan Creek Twp.	75861
York Twp.	87024				

## Ohio Bridge Inventory Guide

---

### GALLIA COUNTY

<u>City/Twp.</u>	<u>FIPS</u>	<u>City/Twp.</u>	<u>FIPS</u>	<u>City/Twp.</u>	<u>FIPS</u>
Centerville	13169	Cheshire	13932	Crown City	19554
Gallipolis	29204	Rio Grande	67258	Vinton	80178
Addison Twp	00422	Cheshire Twp.	13946	Clay Twp.	15462
Gallipolis Twp.	29218	Green Twp	31738	Greenfield Twp	32074
Guyan Twp	32760	Harrison Twp	33824	Huntington Twp	36848
Morgan Twp	52094	Ohio Twp	57974	Perry Twp	61854
Raccoon Twp	65228	Springfield Twp	74120	Walnut Twp	80584

### GEAUGA COUNTY

<u>City/Twp.</u>	<u>FIPS</u>	<u>City/Twp.</u>	<u>FIPS</u>	<u>City/Twp.</u>	<u>FIPS</u>
Aquilla	02274	Burton	10436	Chardon	13554
Hunting Valley	36918	Middlefield	49700	S Russell	73684
Auburn Twp	02904	Bainbridge Twp	03590	Burton Twp	10464
Chardon Twp	13561	Chester Twp	13988	Clairdon Twp	15168
Hambden Twp	32914	Huntsburg Twp	36946	Middlefield Twp	49714
Montville Twp	51842	Munson Twp	53340	Newburry Twp	54292
Parkman Twp	59948	Russell Twp	69232	Thompson Twp	76628
Troy Twp	77574				

### GREENE COUNTY

<u>City/Twp.</u>	<u>FIPS</u>	<u>City/Twp.</u>	<u>FIPS</u>	<u>City/Twp.</u>	<u>FIPS</u>
Beavercreek	04720	Bellbrook	05102	Bowersville	07930
Cedarville	12784	Centerville	13190	Clifton	16056
Fairborn	25914	Huber Heights	36610	Jamestown	38374
Kettering	40040	Spring Valley	74216	Xenia	86772
Yellow Springs	86940	Bath Twp	04220	Beavercreek Twp	04724
Caesarcreek Twp	10856	Cedarville Twp	12798	Jefferson Twp	38626
Miami Twp	49336	New Jasper Twp	54810	Ross Twp	68630
Silvercreek Twp	72473	Spring Valley Twp	74223	Sugarcreek Twp	75201
Xenia Twp	86786				

# Ohio Bridge Inventory Guide

---

## GUERNSEY COUNTY

<u>City/Twp.</u>	<u>FIPS</u>	<u>City/Twp.</u>	<u>FIPS</u>	<u>City/Twp.</u>	<u>FIPS</u>
Byesville	10716	Cambridge	10996	Cumberland	19694
Fairview	26348	Kimbolton	40264	Lore City	44954
Old Washington	58226	Pleasant City	63436	Quaker City	65116
Salesville	70072	Senecaville	71360	Adams Twp	00282
Cambridge Twp	11003	Center Twp	12938	Jackson Twp	37786
Jefferson Twp	38640	Knox Twp	40838	Liberty Twp	43134
Londonderry Twp	44716	Madison Twp	46424	Millwood Twp	50568
Monroe Twp	51380	Oxford Twp	59290	Richland Twp	66698
Spencer Twp	73986	Valley Twp	79156	Washington Twp	81256
Westland Twp	83664	Wheeling Twp	84616	Wills Twp	85708

## HAMILTON COUNTY

<u>City/Twp.</u>	<u>FIPS</u>	<u>City/Twp.</u>	<u>FIPS</u>	<u>City/Twp.</u>	<u>FIPS</u>
Addyston	00436	Amberley	01672	Arlington Hts	02428
Blue Ash	07330	Cheviot	14128	Cincinnati	15000
Cleves	16028	Deer Park	21266	Elmwood Place	25186
Evendale	25802	Fairfax	25942	Fairfield	25970
Forest Park	27706	Glendale	30380	Golf Manor	30786
Greenhills	32158	Harrison	33838	Indian Hill	76582
Lincoln Heights	43722	Lockland	44366	Loveland	45108
Maderia	46312	Mariemont	47600	Milford	50176
Montgomery	51716	Mt Healthy	52752	N College Hill	56322
Newtown	55678	North Bend	56182	Norwood	57386
Reading	65732	Sharonville	71892	Silverton	72522
Springdale	74104	St Bernard	69470	Terrace Park	76428
Woodlawn	86366	Wyoming	86730	Anderson Twp	01980
Colerain Twp	16616	Columbia Twp	16882	Crosby Twp	19470
Delhi Twp	21504	Green Twp	31752	Harrison Twp	33852
Miami Twp	31752	Springfield Twp	74121	Sycamore Twp	75973
Symmes Twp	76028	Whitewater Twp	84938		

## Ohio Bridge Inventory Guide

---

### HANCOCK COUNTY

<u>City/Twp.</u>	<u>FIPS</u>	<u>City/Twp.</u>	<u>FIPS</u>	<u>City/Twp.</u>	<u>FIPS</u>
Arcadia	02316	Arlington	02400	Benton Ridge	05662
Bluffton	07426	Findlay	27048	Fostoria	28014
Jenera	38948	McComb	45808	Mt Blanchard	52598
Mt Cory	52668	Rawson	65634	Van Buren	79394
Vanlue	79534	Allen Twp	01308	Amanda Twp	01644
Biglick Twp	06362	Blanchard Twp	06838	Cass Twp	12392
Delaware Twp	21462	Eagle Twp	23086	Jackson Twp	37800
Liberty Twp	43148	Madison Twp	46438	Marion Twp	47698
Orange Twp	58632	Pleasant Twp	63268	Portage Twp	64066
Union Twp	78330	Van Buren Twp	79408	Washington Twp	81284

### HARDIN COUNTY

<u>City/Twp.</u>	<u>FIPS</u>	<u>City/Twp.</u>	<u>FIPS</u>	<u>City/Twp.</u>	<u>FIPS</u>
Ada	00198	Alger	01210	Dunkirk	22946
Forest	27636	Hale	32837	Kenton	39886
McGuffey	46046	Mt Victory	53144	Patterson	61182
Ridgeway	67118	Blanchard Twp	06866	Buck Twp	09848
Cessna Twp	13316	Dudley Twp	22736	Goshen Twp	31024
Hale Twp	22736	Jackson Twp	37814	Liberty Twp	43162
Lynn Twp	45598	Marion Twp	47712	McDonald Twp	45920
Pleasant Twp	63282	Roundhead Twp	68784	Taylor Creek Twp	76198
Washington Twp	81298				

## Ohio Bridge Inventory Guide

---

### HARRISON COUNTY

<u>City/Twp.</u>	<u>FIPS</u>	<u>City/Twp.</u>	<u>FIPS</u>	<u>City/Twp.</u>	<u>FIPS</u>
Adena	00464	Bowerston	07916	Cadiz	10800
Deersville	21294	Freeport	28798	Harrisville	34090
Hopedale	36260	Jewett	39172	New Athens	54068
Scio	70814	Archer Twp	02358	Athens Twp	02764
Cadiz Twp	10814	Franklin Twp	28308	Freeport Twp	28812
German Twp	29890	Green Twp	31766	Monore Twp	51394
Moorefield Twp	51940	North Twp	56084	Nottingham Twp	57456
Rumley Twp	68994	Short Creek Twp	72361	Stock Twp	74724
Washington Twp	81312				

### HENRY COUNTY

<u>City/Twp.</u>	<u>FIPS</u>	<u>City/Twp.</u>	<u>FIPS</u>	<u>City/Twp.</u>	<u>FIPS</u>
Deshler	21812	Florida	27538	Hamler	33096
Holgate	35854	Liberty Center	43414	Malinta	46942
McClure	45794	Napoleon	53550	New Bavaria	54110
Bartlow Twp	04052	Damascus Twp	20016	Flatrock Twp	27342
Freedom Twp	28700	Harrison Twp	33866	Liberty Twp	43176
Marion Twp	47726	Monroe Twp	51408	Napoleon Twp	53564
Pleasant Twp	63296	Richfield Twp	66502	Ridgeville Twp	67062
Washington Twp	81326				

# Ohio Bridge Inventory Guide

---

## HIGHLAND COUNTY

<u>City/Twp.</u>	<u>FIPS</u>	<u>City/Twp.</u>	<u>FIPS</u>	<u>City/Twp.</u>	<u>FIPS</u>
Greenfield	32088	Highland	35210	Hillsboro	35560
Leesburg	42476	Lynchburg	45542	Mowrystown	53186
Sardinia	70534	Sinking Spring	72578	Brush Creek Twp	09736
Clay Twp	15476	Concord Twp	18168	Dodson Twp	22204
Fairfield Twp	26026	Hamer Twp	32970	Jackson Twp	37828
Liberty Twp	43190	Madison Twp	46452	Marshall Twp	48034
New Market Twp	55048	Paint Twp	59500	Penn Twp	61588
Salem Twp	69862	Union Twp	78344	Washington Twp	81340
White Oak Twp	84826				

## HOCKING COUNTY

<u>City/Twp.</u>	<u>FIPS</u>	<u>City/Twp.</u>	<u>FIPS</u>	<u>City/Twp.</u>	<u>FIPS</u>
Buchtel	09834	Laurelville	42084	Logan	44632
Murray City	53410	Benton Twp	05578	Falls Twp	26488
Good Hope Twp	05578	Green Twp	31780	Laurel Twp	42056
Marion Twp	47740	Perry Twp	61868	Salt Creek Twp	70142
Starr Twp	74405	Ward Twp	80780	Washington Twp	81354

## HOLMES COUNTY

<u>City/Twp.</u>	<u>FIPS</u>	<u>City/Twp.</u>	<u>FIPS</u>	<u>City/Twp.</u>	<u>FIPS</u>
Baltic	03744	Glenmont	3506	Holmesville	35994
Killbuck	40180	Loudonville	45066	Millersburg	50372
Nashville	53634	Berlin Twp	05830	Clark Twp	15280
Hardy Twp	33460	Killbuck Twp	40194	Knox Twp	40852
Mechanic Twp	48692	Monroe Twp	51422	Paint Twp	59514
Prairie Twp	64584	Richland Twp	66712	Ripley Twp	67286
Salt Creek Twp	70156	Walnut Creek Twp	80626	Washington Twp	81368

## Ohio Bridge Inventory Guide

---

### HURON COUNTY

<u>City/Twp.</u>	<u>FIPS</u>	<u>City/Twp.</u>	<u>FIPS</u>	<u>City/Twp.</u>	<u>FIPS</u>
Bellevue	05228	Greenwich	32368	Milan	50134
Monroeville	51618	N Fairfield	56420	New London	54908
Norwalk	57302	Plymouth	63800	Wakeman	80458
Willard	85232	Bronson Twp	09148	Clarksfield Twp	15364
Fairfield Twp	26040	Fitchville Twp	27216	Greenfield Twp	32102
Greenwich Twp	32382	Hartland Twp	34258	Lyme Twp	45514
New Haven Twp	54712	New London Twp	54922	Norwalk Twp	57316
Norwich Twp	57358	Peru Twp	62246	Richmond Twp	66810
Ridgefield Twp	67006	Ripley Twp	67300	Sherman Twp	72193
Townsend Twp	77158	Wakeman Twp	80472		

### JACKSON COUNTY

<u>City/Twp.</u>	<u>FIPS</u>	<u>City/Twp.</u>	<u>FIPS</u>	<u>City/Twp.</u>	<u>FIPS</u>
Coalton	16434	Jackson	37842	Oak Hill	57596
Wellston	82712	Bloomfield Twp	07090	Coal Twp	16336
Franklin Twp	28322	Hamilton Twp	33040	Jackson Twp	37856
Jefferson Twp	38654	Liberty Twp	43204	Lick Twp	43442
Madison Twp	46466	Milton Twp	50624	Scioto Twp	70856
Washington Twp	81382				

## Ohio Bridge Inventory Guide

---

### JEFFERSON COUNTY

<u>City/Twp.</u>	<u>FIPS</u>	<u>City/Twp.</u>	<u>FIPS</u>	<u>City/Twp.</u>	<u>FIPS</u>
Adena	00464	Amsterdam	01938	Bergholz	05718
Bloomington	07202	Dillonvale	22022	Empire	25368
Irondale	37422	Mingo Junction	50904	Mt Pleasant	52976
New Alexandria	54012	Rayland	65662	Richmond	66824
Salineville	70100	Smithfield	72760	Steubenville	74608
Stratton	75000	Titltonsville	76806	Toronto	77112
Wintersville	86184	Yorkville	87178	Brush Creek Twp	09750
Cross Creek Twp	19484	Island Creek Twp	37534	Knox Twp	40866
Mount Pleasant Twp	52990	Ross Twp	68644	Salem Twp	69876
Saline Twp	70086	Smithfield Twp	72767	Springfield Twp	74122
Steubenville Twp	74615	Warren Twp	80878	Wayne Twp	82180
Wells Twp	82698				

### KNOX COUNTY

<u>City/Twp.</u>	<u>FIPS</u>	<u>City/Twp.</u>	<u>FIPS</u>	<u>City/Twp.</u>	<u>FIPS</u>
Centerburg	13036	Danville	20114	Fredericktown	28658
Gambier	29246	Gann	29288	Martinsburg	48090
Mt Vernon	53102	Utica	79114	Berlin Twp	05844
Brown Twp	09470	Butler Twp	10590	Clay Twp	15504
Clinton Twp	16140	College Twp	16686	Harrison Twp	33880
Hilliar Twp	35462	Howard Twp	33880	Jackson Twp	37870
Jefferson Twp	38668	Liberty Twp	43218	Middlebury Twp	49658
Milford Twp	50204	Miller Twp	50330	Monroe Twp	51436
Morgan Twp	52108	Morris Twp	52290	Pike Twp	62652
Pleasant Twp	63310	Union Twp	78358	Wayne Twp	82194



## Ohio Bridge Inventory Guide

---

### LAKE COUNTY

<u>City/Twp.</u>	<u>FIPS</u>	<u>City/Twp.</u>	<u>FIPS</u>	<u>City/Twp.</u>	<u>FIPS</u>
Eastlake	23618	Fairport Harbor	26306	Grand River	31234
Kirtland	40642	Kirtland Hills	40670	Lakeline	41398
Madison	46480	Mentor	49056	Mentor On Lake	49098
North Perry	56910	Painesville	59416	Perry	61882
Timberlake	76834	Waite Hill	80402	Wickliffe	85036
Willoughby	85484	Willoughby Hills	85512	Willowick	85638
Concord Twp	18196	Leroy Twp	42812	Madison Twp	49494
Painesville Twp	59430	Perry Twp	61896	North Madison (CDP)	56812

### LAWRENCE COUNTY

<u>City/Twp.</u>	<u>FIPS</u>	<u>City/Twp.</u>	<u>FIPS</u>	<u>City/Twp.</u>	<u>FIPS</u>
Athalia	02722	Chesapeake	13904	Coal Grove	16378
Hanging Rock	33194	Ironton	37464	Proctorville	64766
South Point	73670	Aid Twp	00562	Decatur Twp	21084
Elizabeth Twp	24822	Fayette Twp	26782	Hamilton Twp	33054
Lawrence Twp	42154	Mason Twp	48174	Perry Twp	61910
Rome Twp	68280	Symmes Twp	76031	Union Twp	78372
Upper Twp	78974	Washington Twp	81396	Windsor Twp	86002

## Ohio Bridge Inventory Guide

---

### LICKING COUNTY

<u>City/Twp.</u>	<u>FIPS</u>	<u>City/Twp.</u>	<u>FIPS</u>	<u>City/Twp.</u>	<u>FIPS</u>
Alexandria	01154	Buckeye Lake	09890	Granville	31402
Gratiot	31458	Hanover	33292	Hartford	34202
Heath	34748	Hebron	34790	Johnstown	39340
Kirkersville	40572	New Albany	53970	Newark	54040
Pataskala	61112	Reynoldsburg	66390	St Louisville	69652
Utica	79114	Bennington Twp	05494	Bowling Green Twp	07944
Burlington Twp	10366	Eden Twp	24332	Etna Twp	25690
Fallsbury Twp	26530	Franklin Twp	28336	Granville Twp	31416
Hanover Twp	33299	Harrison Twp	33894	Hartford Twp	34188
Hopewell Twp	36316	Jersey Twp	39102	Liberty Twp	43232
Licking Twp	43456	Madison Twp	46508	Mary Ann Twp	48132
McKean Twp	46116	Monroe Twp	51405	Newark Twp	54054
Newton Twp	55580	Perry Twp	61924	Saint Albans Twp	69456
Union Twp	78400	Washington Twp	81410		

### LOGAN COUNTY

<u>City/Twp.</u>	<u>FIPS</u>	<u>City/Twp.</u>	<u>FIPS</u>	<u>City/Twp.</u>	<u>FIPS</u>
Belle Center	05116	Bellefontaine	05130	Degraff	21378
Huntsville	36988	Lakeview	41608	Quincy	65200
Ridgeway	67118	Rushsylvania	69176	Russells Point	69302
Valley Hi	79226	W Liberty	83734	W Mansfield	83818
Zanesfield	88070	Bloomfield Twp	07118	Bokes Creek Twp	07552
Harrison Twp	33908	Jefferson Twp	38682	Lake Twp	41286
Liberty Twp	43246	Mcarthur Twp	45682	Miami Twp	49378
Monroe Twp	51464	Perry Twp	61938	Pleasant Twp	63324
Richland Twp	66740	Rushcreek Twp	69134	Stokes Twp	74780
Union Twp	78414	Washington Twp	81424	Zane Twp	88042

# Ohio Bridge Inventory Guide

---

## LORAIN COUNTY

---

<u>City/Twp.</u>	<u>FIPS</u>	<u>City/Twp.</u>	<u>FIPS</u>	<u>City/Twp.</u>	<u>FIPS</u>
Amherst	01798	Avon	03352	Avon Lake	03464
Elyria	25256	Grafton	31150	Kipton	40544
Lagrange	41230	Lorain	44856	N Ridgeville	56966
Oberlin	57834	Rochester	67762	S Amherst	73040
Sheffield	72060	Sheffield Lake	72088	Vermilion	79716
Wellington	82642	Amherst Twp	01812	Brighton Twp	08770
Brownhelm Twp	09568	Camden Twp	11010	Carlisle Twp	12140
Columbia Twp	16910	Eaton Twp	24220	Elyria Twp	25270
Grafton Twp	31164	Henrietta Twp	34972	Huntington Twp	36876
Lagrange Twp	41244	New Russia Twp	55446	Penfield Twp	61532
Pittsfield Twp	62960	Rochester Twp	67776	Sheffield Twp	72067
Wellington Twp	67776				

## LUCAS COUNTY

<u>City/Twp.</u>	<u>FIPS</u>	<u>City/Twp.</u>	<u>FIPS</u>	<u>City/Twp.</u>	<u>FIPS</u>
Berkey	05732	Harbor View	33376	Holland	35882
Maumee	48342	Oregon	58730	Ottawa Hills	59010
Swanton	75896	Sylvania	76022	Toledo	77000
Waterville	81858	Whitehouse	84770	Harding Twp	33418
Jerusalem Twp	39116	Monclova Twp	51156	Providence Twp	64836
Richfield Twp	66516	Spencer Twp	73990	Springfield Twp	74123
Swanton Twp	75903	Sylvania Twp	76025	Washington Twp	81438
Waterville Twp	81872				

## Ohio Bridge Inventory Guide

---

### MADISON COUNTY

<u>City/Twp.</u>	<u>FIPS</u>	<u>City/Twp.</u>	<u>FIPS</u>	<u>City/Twp.</u>	<u>FIPS</u>
London	44674	Midway	50008	Mt Sterling	53046
Plain City	63030	South Solon	73768	West Jefferson	83580
Canaan Twp	11234	Darby Twp	20142	Deer Creek Twp	21154
Fairfield Twp	26068	Jefferson Twp	38696	Monroe Twp	51478
Oak Run Twp	57708	Paint Twp	59528	Pike Twp	62666
Pleasant Twp	63338	Range Twp	65480	Somerford Twp	72960
Stokes Twp	74784	Union Twp	78428		

### MAHONING COUNTY

<u>City/Twp.</u>	<u>FIPS</u>	<u>City/Twp.</u>	<u>FIPS</u>	<u>City/Twp.</u>	<u>FIPS</u>
Alliance	01420	Beloit	05410	Campbell	11066
Canfield	11360	Columbiana	17036	Craig Beach	19106
Lowellville	45178	New Middletown	55118	Poland	63954
Salem	69834	Sebring	71220	Struthers	75126
Washingtonville	81732	Youngstown	88000	Austintown Twp	03198
Beaver Twp	04668	Berlin Twp	05858	Boardman Twp	07468
Canfield Twp	11374	Coitsville Twp	16476	Ellsworth Twp	25088
Goshen Twp	31038	Green Twp	31794	Jackson Twp	37884
Milton Twp	50638	Poland Twp	63968	Smith Twp	72740
Springfield Twp	74124	Austintown (CDP)	03184	Boardman (CDP)	07454

### MARION COUNTY

<u>City/Twp.</u>	<u>FIPS</u>	<u>City/Twp.</u>	<u>FIPS</u>	<u>City/Twp.</u>	<u>FIPS</u>
Caledonia	10954	Green Camp	31948	Larue	41902
Marion	47754	Morrall	52276	New Bloomington	54152
Prospect	64780	Waldo	80500	Big Island Twp	06348
Bowling Green Twp	07958	Claridon Twp	15196	Grand Prairie Twp	31192
Grand Twp	31178	Green Camp Twp	31962	Marion Twp	47768
Montgomery Twp	51730	Pleasant Twp	63352	Prospect Twp	64794
Richland Twp	66754	Salt Rock Twp	70240	Scott Twp	71073
Tully Twp	77742	Waldo Twp	80514		

# Ohio Bridge Inventory Guide

---

## MEDINA COUNTY

<u>City/Twp.</u>	<u>FIPS</u>	<u>City/Twp.</u>	<u>FIPS</u>	<u>City/Twp.</u>	<u>FIPS</u>
Brunswick	09680	Chippewa Lake	14282	Creston	19344
Gloria Glens Park	30660	Lodi	44604	Medina	48790
Rittman	67356	Seville	71486	Spencer	73992
Wadsworth	80304	Westfield Center	83468	Brunswick Hills Twp	09708
Chatham Twp	13750	Granger Twp	31374	Guildford Twp	32676
Harrisville Twp	341048	Hinckley	35644	Homer Twp	36078
Lafayette Twp	41174	Litchfield Twp	44072	Liverpool Twp	44240
Median Twp	48804	Montville Twp	51856	Sharon Twp	71801
Spencer Twp	73999	Wadsworth Twp	80318	Westfield Twp	83426
York Twp	87052				

## MEIGS COUNTY

<u>City/Twp.</u>	<u>FIPS</u>	<u>City/Twp.</u>	<u>FIPS</u>	<u>City/Twp.</u>	<u>FIPS</u>
Middleport	49756	Pomeroy	64024	Racine	65256
Rutland	69358	Syracuse	76050	Bedford Twp.	04906
Chester Twp	14016	Columbia Twp	16924	Lebanon Twp.	42336
Letart Twp	42868	Olive Twp	58282	Orange Twp	58646
Rutland Twp	69372	Salem Twp	69904	Salisbury Twp	70114
Scio Twp.	70996	Sutton Twp.	75847		

## MERCER COUNTY

<u>City/Twp.</u>	<u>FIPS</u>	<u>City/Twp.</u>	<u>FIPS</u>	<u>City/Twp.</u>	<u>FIPS</u>
Black Creek Twp	06586	Burkettsville	10296	Butler Twp	10604
Celina	12868	Center Twp	12952	Chickasaw	14156
Coldwater	16532	Dublin Twp	22708	Ft Recovery	27902
Franklin Twp	28350	Gibson Twp	30058	Granville Twp	31430
Hopewell Twp	36344	Jefferson Twp	38724	Liberty Twp	43260
Marion Twp	47782	Mendon	49042	Montezuma	51674
Recovery Twp	65781	Rockford	67874	St Henry	69540
Union Twp	78442	Washington Twp	81452		

# Ohio Bridge Inventory Guide

---

## MIAMI COUNTY

<u>City/Twp.</u>	<u>FIPS</u>	<u>City/Twp.</u>	<u>FIPS</u>	<u>City/Twp.</u>	<u>FIPS</u>
Bethel Twp	06110	Bradford	08084	Brown Twp	09498
Casstown	12462	Concord Twp	18224	Covington	19050
Elizabeth Twp	24836	Fletcher	27412	Huber Heights	36610
Laura	42028	Lost Creek Twp	44968	Ludlow Falls	45374
Monroe Twp	51492	Newberry Twp	54138	Newton Twp	55594
Piqua	62848	Pleasant Hill	63534	Potsdam	64430
Spring Creek Twp	74097	Staunton Twp	74475	Tipp City	76876
Troy	77588	Union Twp	78456	Union	78470
Washington Twp	81466	West Milton	83902		

## MONROE COUNTY

<u>City/Twp.</u>	<u>FIPS</u>	<u>City/Twp.</u>	<u>FIPS</u>	<u>City/Twp.</u>	<u>FIPS</u>
Antioch	02148	Beallsville	04542	Clarington	15210
Graysville	31542	Jerusalem	39130	Lewisville	42980
Miltonsburg	50722	Stafford	74300	Wilson	85834
Woodsfield	86436	Adams .Twp	00296	Benton Twp	05606
Bethel Twp	06124	Center Twp	12966	Franklin Twp	28357
Green Twp	31808	Jackson Twp	37898	Lee Twp	42448
Malaga Twp	46928	Ohio Twp	57988	Perry Twp	61952
Salem Twp	69918	Seneca Twp	71349	Summit Twp	75497
Sunsbury Twp	75686	Switzerland Twp	75945	Washington Twp	81480
Wayne Twp	82208				

## Ohio Bridge Inventory Guide

---

### MONTGOMERY COUNTY

<u>City/Twp.</u>	<u>FIPS</u>	<u>City/Twp.</u>	<u>FIPS</u>	<u>City/Twp.</u>	<u>FIPS</u>
Brookville	09358	Carlisle	12168	Centerville	13190
Clayton	15644	Dayton	21000	Englewood	25396
Farmersville	26656	Germantown	29932	Huber Heights	36610
Kettering	40040	Miamisburg	49434	Moraine	52010
New Lebanon	54852	Oakwood	57764	Phillipsburg	62414
Riverside	67468	Springboro	74076	Trotwood	77504
Union	78470	Vandalia	79492	Verona	79898
W Carrollton	83111	Butler Twp	10618	Clay Twp	15518
German Twp	29904	Harrison Twp	33922	Jackson Twp	37912
Jefferson Twp	38738	Miami Twp	49392	Perry Twp	61966
Washington Twp	81494				

### MORGAN COUNTY

<u>City/Twp.</u>	<u>FIPS</u>	<u>City/Twp.</u>	<u>FIPS</u>	<u>City/Twp.</u>	<u>FIPS</u>
Chesterhill	14086	Malta	46970	McConnelsville	45822
Stockport	74748	Bloom Twp	06964	Bristol Twp	08910
Center Twp	12980	Deerfield Twp	21182	Homer Twp	36092
Malta Twp	46984	Manchester Twp	47040	Marion Twp	47796
Manchester Twp	47040	Marion Twp	47796	Meigsville Twp	48930
Morgan Twp	52122	Penn Twp	61602	Union Twp	78484
Windsor Twp	86016	York Twp	87066		

## Ohio Bridge Inventory Guide

---

### MORROW COUNTY

<u>City/Twp.</u>	<u>FIPS</u>	<u>City/Twp.</u>	<u>FIPS</u>	<u>City/Twp.</u>	<u>FIPS</u>
Cardington	12084	Chesterville	14114	Edison	24598
Fulton	29050	Marengo	47558	Mt Gilead	52738
Sparta	73950	Bennington Twp	05508	Canaan Twp	11248
Cardington Twp	12098	Chester Twp	14030	Congress Twp	18294
Franklin Twp	28378	Gilead Twp	30128	Harmony Twp	33600
Lincoln Twp	43680	North Bloomfield Twp.	56224	Perry Twp	61980
Peru Twp	62260	South Bloomfield Twp.	73061	Troy Twp	77602
Washington Twp	81508	Westfield Twp	83454		

### MUSKINGUM COUNTY

<u>City/Twp.</u>	<u>FIPS</u>	<u>City/Twp.</u>	<u>FIPS</u>	<u>City/Twp.</u>	<u>FIPS</u>
Adamsville	00380	Dresden	22610	Fazeysburg	28574
Fultonham	29064	Gratiot	31458	New Concord	54446
Norwich	57372	Philo	62442	Roseville	68560
S Zanesville	73894	Zanesville	88084	Adams Twp	00310
Blue Rock Twp	07398	Brush Creek Twp	09757	Cass Twp	12406
Clay Twp	15532	Falls Twp	26502	Harrison Twp	33936
Highland Twp	35238	Hopewell Twp	36372	Jackson Twp	37926
Jefferson Twp	38752	Licking Twp	43470	Madison Twp	46536
Meigs Twp	48916	Monroe Twp	51506	Muskingum Twp	53438
Newton Twp	55608	Perry Twp	61994	Rich Hill Twp	66600
Salem Twp	69932	Salt Creek Twp	70170	Springfield Twp	74125
Union Twp	78498	Washington Twp	81522	Wayne Twp	82236



## Ohio Bridge Inventory Guide

---

### NOBLE COUNTY

<u>City/Twp.</u>	<u>FIPS</u>	<u>City/Twp.</u>	<u>FIPS</u>	<u>City/Twp.</u>	<u>FIPS</u>
Batesville	04192	Belle Valley	05158	Caldwell	10940
Dexter City	21910	Sarahsville	70520	Summerfield	75460
Beaver Twp	04682	Brookfield Twp	09162	Buffalo Twp	10142
Center Twp	12994	Elk Twp	24878	Enoch Twp	25438
Jackson Twp	37940	Jefferson Twp	38766	Marion Twp	47810
Noble Twp	56028	Olive Twp	58310	Seneca Twp	71352
Sharon Twp	71826	Stock Twp	74728	Wayne Twp	82250

### OTTAWA COUNTY

<u>City/Twp.</u>	<u>FIPS</u>	<u>City/Twp.</u>	<u>FIPS</u>	<u>City/Twp.</u>	<u>FIPS</u>
Clay Center	15588	Elmore	25144	Genoa	29722
Marblehead	47502	Oak Harbor	57582	Port Clinton	64150
Put-In-Bay	65032	Rocky Ridge	68042	Allen Twp	01322
Bay Twp	04304	Benton Twp	05620	Carroll Twp	12266
Catawba Island Twp	12588	Clay Twp	15546	Danbury Twp	20058
Erie Twp	25578	Harris Twp	33726	Portage Twp	64080
Put-In-Bay Twp.	65046	Salem Twp	69946		

### PAULDING COUNTY

<u>City/Twp.</u>	<u>FIPS</u>	<u>City/Twp.</u>	<u>FIPS</u>	<u>City/Twp.</u>	<u>FIPS</u>
Antwerp	02204	Broughton	09386	Cecil	12700
Grover Hill	32620	Haviland	34552	Latty	41986
Melrose	49000	Oakwood	57792	Paulding	61252
Payne	61322	Scott	71080	Auglaize Twp.	03002
Benton Twp	05634	Blue Creek Twp	03002	Brown Twp	09512
Carryall Twp	12308	Crane Twp	19176	Emerald Twp	25298
Harrison Twp	33950	Jackson Twp	37954	Latty Twp	42000
Paulding Twp	61266	Washington Twp	81536		

## Ohio Bridge Inventory Guide

---

### PERRY COUNTY

<u>City/Twp.</u>	<u>FIPS</u>	<u>City/Twp.</u>	<u>FIPS</u>	<u>City/Twp.</u>	<u>FIPS</u>
Corning	18770	Crooksville	19456	Glenford	30436
Hemlock	34888	Junction City	39508	New Lexington	54866
New Straitsville	55552	Rendville	66222	Roseville	68560
Shawnee	71962	Someset	72977	Thornville	76680
Bearfield Twp	04584	Clayton Twp	15658	Coal Twp	16350
Harrison Twp	33964	Hopewell Twp	36386	Jackson Twp	37968
Madison Twp	46550	Monday Creek Twp	51198	Monroe Twp	51520
Pike Twp	62680	Pleasant Twp	63366	Reading Twp	65760
Salt Lick Twp	70226	Thorn Twp	76659		

### PICKAWAY COUNTY

<u>City/Twp.</u>	<u>FIPS</u>	<u>City/Twp.</u>	<u>FIPS</u>	<u>City/Twp.</u>	<u>FIPS</u>
Ashville	02680	Circleville	15070	Commercial Point	18070
Darbyville	20212	Harrisburg	33740	New Holland	54726
Orient	58800	South Bloomfield	73068	Tarlton	76148
Williamsport	85414	Circleville Twp	15077	Darby Twp	20156
Deer Creek Twp	21168	Harrison Twp	33978	Jackson Twp	37982
Madison Twp	46564	Monroe Twp	51534	Muhlenberg Twp	53256
Perry Twp	62008	Pickaway Twp	62484	Salt Creek Twp	70184
Scioto Twp	70870	Walnut Twp	80598	Washington Twp	81550
Wayne Twp	82264				

## Ohio Bridge Inventory Guide

---

### PIKE COUNTY

<u>City/Twp.</u>	<u>FIPS</u>	<u>City/Twp.</u>	<u>FIPS</u>	<u>City/Twp.</u>	<u>FIPS</u>
Beaver	04696	Piketon	62708	Waverly	81942
Beaver Twp	04710	Benton Twp	05648	Camp Creek Twp	11122
Jackson Twp	37996	Marion Twp	47824	Mifflin Twp	50078
Newton Twp	55622	Pebble Twp	61392	Pee Twp	61434
Perry Twp	62022	Scioto Twp	70884	Seal Twp	71171
Sunfish Twp	75637	Union Twp	78512		

### PORTAGE COUNTY

<u>City/Twp.</u>	<u>FIPS</u>	<u>City/Twp.</u>	<u>FIPS</u>	<u>City/Twp.</u>	<u>FIPS</u>
Aurora	03086	Brady Lake	08168	Garrettsville	29442
Hiram	35658	Kent	39872	Mantua	47180
Mogadore	51058	Ravenna	65592	Streetsboro	75014
Sugar Brush Knoll	75196	Tallmadge	76106	Windham	85946
Atwater Twp	02862	Brimfield Twp	08840	Charlestown Twp	13610
Deerfield Twp	21210	Edinburg Twp	24584	Franklin Twp	28392
Freedom Twp	28742	Hiram Twp	35672	Mantua Twp	47194
Nelson Twp	53858	Palmyra Twp	59668	Paris Twp	59822
Randolph Twp	65462	Ravenna Twp	65606	Rootstown Twp	68392
Shalersville Twp	71731	Suffield Twp	75189	Windham Twp	85960

## Ohio Bridge Inventory Guide

---

### PREBLE COUNTY

<u>City/Twp.</u>	<u>FIPS</u>	<u>City/Twp.</u>	<u>FIPS</u>	<u>City/Twp.</u>	<u>FIPS</u>
Camden	11024	College Corner	16700	Eaton	24234
Eldorado	24766	Gratis	31472	Lewisburg	42938
New Paris	55188	Verona	79898	W Alexander	82880
W Elkton	83216	W Manchester	82880	Dixon Twp	22106
Gasper Twp	29484	Gratis Twp	31486	Harrison Twp	33992
Israel Twp	37590	Jackson Twp	38010	Jefferson Twp	38780
Lanier Twp	41846	Monroe Twp	51548	Somers Twp	72964
Twin Twp	77994	Washington Twp	81564		

### PUTNAM COUNTY

<u>City/Twp.</u>	<u>FIPS</u>	<u>City/Twp.</u>	<u>FIPS</u>	<u>City/Twp.</u>	<u>FIPS</u>
Belmore	05396	Cloverdale	16266	Columbus Grove	18014
Continental	18504	Dupont	22974	Ft Jennings	27818
Gilboa	30114	Glandorf	30282	Kalida	39536
Leipsic	42602	Miller City	50358	Ottawa	58982
Ottoville	59052	Pandora	59738	West Leipsic	83706
Blanchard Twp	06880	Greensburg Twp	32228	Jackson Twp	38024
Jennings Twp	38976	Liberty Twp	43288	Monroe Twp	51562
Monterey Twp	51660	Ottawa Twp	58996	Palmer Twp	59612
Perry Twp	62036	Pleasant Twp	63380	Riley Twp	67174
Sugar Creek Twp	75206	Union Twp	78526	Van Buren Twp	79450

## Ohio Bridge Inventory Guide

---

### RICHLAND COUNTY

<u>City/Twp.</u>	<u>FIPS</u>	<u>City/Twp.</u>	<u>FIPS</u>	<u>City/Twp.</u>	<u>FIPS</u>
Bellville	05284	Butler	10632	Crestline	19330
Galion	29162	Lexington	42994	Lucas	45276
Mansfield	47138	Ontario	58520	Plymouth	63800
Shelby	72102	Shiloh	72298	Bloomington Twp	07230
Butler Twp	10646	Cass Twp	12420	Franklin Twp	28406
Jackson Twp	38038	Jefferson Twp	38794	Madison Twp	46578
Mifflin Twp	50092	Monroe Twp	51576	Perry Twp	62050
Plymouth Twp	63814	Sandusky Twp	70394	Sharon Twp	71830
Springfield Twp	74128	Troy Twp	77616	Washington Twp	81578
Weller Twp	82628	Worthington Twp	86618		

### ROSS COUNTY

<u>City/Twp.</u>	<u>FIPS</u>	<u>City/Twp.</u>	<u>FIPS</u>	<u>City/Twp.</u>	<u>FIPS</u>
Adelphi	00450	Bainbridge	03604	Chillicothe	14184
Clarksburg	15336	Frankfort	28182	Kingston	40376
South Salem	73698	Buckskin Twp	10016	Colerain Twp	16630
Concord Twp	18238	Deerfield Twp	21224	Franklin Twp	28420
Green Twp	31822	Harrison Twp	34006	Huntington Twp	36890
Jefferson Twp	38808	Liberty Twp	43302	Paint Twp	59542
Paxton Twp	43302	Paint Twp	59542	Paxton Twp	61308
Scioto Twp	70898	Springfield Twp	74129	Twin Twp	78008
Union Twp	78540				

## Ohio Bridge Inventory Guide

---

### SANDUSKY COUNTY

<u>City/Twp.</u>	<u>FIPS</u>	<u>City/Twp.</u>	<u>FIPS</u>	<u>City/Twp.</u>	<u>FIPS</u>
Bellevue	05228	Burgoon	10282	Clyde	16308
Elmore	25144	Fremont	28826	Gibsonburg	30072
Green Springs	32256	Helena	34860	Lindsey	43904
Woodville	86492	Ballville Twp	03730	Green Creek Twp	31990
Jackson Twp	38052	Madison Twp	46592	Rice Twp	66460
Riley Twp	67188	Sandusky Twp	70408	Scott Twp	71087
Townsend Twp	77162	Washington Twp	81592	Woodville Twp	86506
York Twp	87080				

### SCIOTO COUNTY

<u>City/Twp.</u>	<u>FIPS</u>	<u>City/Twp.</u>	<u>FIPS</u>	<u>City/Twp.</u>	<u>FIPS</u>
New Boston	54166	Otway	59066	Portsmouth	64304
Rarden	65508	S Webster	73824	Bloom Twp	06992
Brush Creek Twp	09764	Clay Twp	15560	Green Twp	31836
Harrison Twp	34020	Jefferson Twp	38815	Madison Twp	46606
Morgan Twp	52150	Nile Twp	55902	Porter Twp	642006
Rarden Twp	65522	Rush Twp	69092	Union Twp	78554
Valley Twp	79170	Vernon Twp	79828	Washington Twp	81606

## Ohio Bridge Inventory Guide

---

### SENECA COUNTY

<u>City/Twp.</u>	<u>FIPS</u>	<u>City/Twp.</u>	<u>FIPS</u>	<u>City/Twp.</u>	<u>FIPS</u>
Attica	02820	Bettsville	06194	Bloomville	07286
Fostoria	28014	Green Springs	32256	New Riegel	55398
Republic	66320	Tiffin	76778	Adams Twp	00324
Big Spring Twp	06432	Bloom Twp	07006	Clinton Twp	16154
Eden Twp	24346	Hopewell Twp	36400	Jackson Twp	38066
Liberty Twp	43316	Loudon Twp	45052	Pleasant Twp	63394
Reed Twp	65942	Scipio Twp	71024	Seneca Twp	71355
Thompson Twp	76632	Venice Twp	79674		

### SHELBY COUNTY

<u>City/Twp.</u>	<u>FIPS</u>	<u>City/Twp.</u>	<u>FIPS</u>	<u>City/Twp.</u>	<u>FIPS</u>
Anna	02092	Botkins	07832	Ft Loramie	27832
Jackson Center	38220	Kettlersville	40054	Lockington	44352
Port Jefferson	64262	Russia	69344	Sidney	72424
Clinton Twp	16168	Cynthian Twp	19834	Dinsmore Twp	22050
Franklin Twp	28434	Green Twp	31850	Jackson Twp	38080
Loramie Twp	44884	McLean Twp	46172	Orange Twp	58660
Perry Twp	62064	Salem Twp	69960	Turtle Creek Twp	77854
Van Buren Twp	79464	Washington Twp	81620		

# Ohio Bridge Inventory Guide

---

## STARK COUNTY

<u>City/Twp.</u>	<u>FIPS</u>	<u>City/Twp.</u>	<u>FIPS</u>	<u>City/Twp.</u>	<u>FIPS</u>
ALLIANCE	01420	LEXINGTON TWP	43022	MEYERS LAKE	49294
BREWSTER	08504	NIMISHILLEN TWP	55944	NAVARRE	53690
CANTON	12000	PARIS TWP	59850	WAYNESBURG	82376
EAST SPARTA	24052	PIKE TWP	62694	BETHLEHEM TWP	06180
HILLS AND DALES	35532	SANDY TWP	70436	JACKSON TWP	38094
LOUISVILLE	45094	TUSCARAWAS TWP	77910	LAWRENCE TWP	42168
MASSILLON	48244	BEACH CITY	04458	MARLBORO TWP	47936
MINERVA	50834	CANAL FULTON	11304	OSNABURG TWP	58926
NORTH CANTON	56294	EAST CANTON	23324	PERRY TWP	62078
WILMOT	85806	HARTVILLE	34328	PLAIN TWP	62988
CANTON TWP	12014	LIMAVILLE	43596	SUGAR CREEK TWP	75208
LAKE TWP	41314	MAGNOLIA	46844	WASHINGTON TWP	81634



## Ohio Bridge Inventory Guide

---

### SUMMIT COUNTY

<u>City/Twp.</u>	<u>FIPS</u>	<u>City/Twp.</u>	<u>FIPS</u>	<u>City/Twp.</u>	<u>FIPS</u>
Akron	01000	Barberton	03828	Boston Heights	07790
Clinton	16182	Cuyahoga Falls	19778	Fairlawn	26166
Green	31860	Hudson	36651	Lakemore	41454
Macedonia	45976	Mogadore	51058	Munroe Falls	53312
New Franklin	54562	Northfield	56448	Norton	57260
Peninsula	61574	Reminderville	66152	Richfield	66530
Silver Lake	72494	Stow	74944	Tallmadge	76106
Twinsburg	78050	Bath Twp	04248	Boston Twp	07776
Copley Twp	18658	Coventry Twp	19036	Northfield Center Twp	56490
Richfield Twp	66544	Sagamore Hills Twp	06428	Springfield Twp	74130
Twinsburg Twp	78064				

### TRUMBULL COUNTY

<u>City/Twp.</u>	<u>FIPS</u>	<u>City/Twp.</u>	<u>FIPS</u>	<u>City/Twp.</u>	<u>FIPS</u>
Cortland	18812	Girard	30198	Hubbard	36582
Lordstown	44912	McDonald	45934	Newton Falls	55650
Niles	55916	Orangeville	58674	W Farmington	83384
Warren	80892	Yankee Lake	86856	Youngstown	88000
Bazetta Twp	04444	Bloomfield Twp	07160	Braceville Twp	08056
Bristol Twp	08938	Brookfield Twp	09190	Champion Twp	13470
Farmington Twp	26684	Fowler Twp	28098	Green Twp	32046
Gustavus Twp	32732	Hartford Twp	34230	Howland Twp	36554
Hubbard Twp	36596	Johnston Twp	39298	Kinsman Twp	40502
Liberty Twp	43344	Mecca Twp	48678	Mespotamia Twp	49210
Newton Twp	55636	Southington Twp	73397	Vernon Twp	79856
Vienna Twp	80052	Warren Twp	80906	Weathersfield Twp	82446

# Ohio Bridge Inventory Guide

---

## TUSCARAWAS COUNTY

<u>City/Twp.</u>	<u>FIPS</u>	<u>City/Twp.</u>	<u>FIPS</u>	<u>City/Twp.</u>	<u>FIPS</u>
Baltic	03744	Barnhill	03940	Bolivar	07594
Dennison	21714	Dover	22456	Gnadenhutten	30702
Midvale	49966	Mineral City	50764	Newcomerstown	54432
New Philadelphia	55216	Parral	61056	Port Washington	64346
Roswell	68742	Stone Creek	74804	Strasburg	74958
Sugar Creek	75210	Tuscarawas	77924	Uhrichsville	78176
Zoar	88168	Auburn Twp	02918	Bucks Twp	09988
Clay Twp	15574	Dover Twp	22470	Fairfield Twp	26082
Franklin Twp	28462	Goshen Twp	31066	Jefferson Twp	38836
Lawrence Twp	42182	Mill Twp	50232	Oxford Twp	59304
Perry Twp	62092	Rush Twp	69106	Salem Twp	69974
Sandy Twp	70443	Sugar Creek Twp	75217	Union Twp	78568
Warren Twp	80920	Warwick Twp	81060	Washington Twp	81648
Wayne Twp	82292	York Twp	87094		

## Ohio Bridge Inventory Guide

---

### UNION COUNTY

<u>City/Twp.</u>	<u>FIPS</u>	<u>City/Twp.</u>	<u>FIPS</u>	<u>City/Twp.</u>	<u>FIPS</u>
Dublin	22694	Magnetic Springs	46830	Marysville	48160
Milford Center	50218	Plain City	63030	Richwood	66936
Unionville Center	78834	Allen Twp	01336	Claibourne Twp	15112
Darby Twp	20170	Dover Twp	22484	Jackson Twp	38108
Jerome Twp	39046	Leesburg Twp	42490	Liberty Twp	43358
Mill Creek Twp	42490	Liberty Twp	43358	Mill Creek Twp	50288
Paris Twp	59864	Taylor Twp	76194	Union Twp	78582
Washington Twp	81662	York Twp	87122		

### VAN WERT COUNTY

<u>City/Twp.</u>	<u>FIPS</u>	<u>City/Twp.</u>	<u>FIPS</u>	<u>City/Twp.</u>	<u>FIPS</u>
Convoy	18546	Delphos	21602	Elgin	24794
Middlepoint	49728	Ohio City	58002	Scott	71808
Van Wert	79562	Vendocia	79632	Willshire	85736
Wren	86632	Harrison Twp	34034	Hoaglin Twp	35756
Jackson Twp	38122	Jennings Twp	38990	Liberty Twp	43372
Pleasant Twp	63408	Ridge Twp	66978	Tully Twp	77756
Union Twp	78596	Washington Twp	81676	Willshire Twp	85750
York Twp	87136				

### VINTON COUNTY

<u>City/Twp.</u>	<u>FIPS</u>	<u>City/Twp.</u>	<u>FIPS</u>	<u>City/Twp.</u>	<u>FIPS</u>
Hamden	32956	Mcarthur	45696	Wilkesville	85190
Zaleski	88028	Brown Twp	09526	Clinton Twp	16210
Eagle Twp	23100	Elk Twp	24892	Harrison Twp	34048
Jackson Twp	38136	Knox Twp	40880	Madison Twp	46620
Richland Twp	66768	Swan Twp	75854	Vinton Twp	80192
Wilkesville Twp	85204				

## Ohio Bridge Inventory Guide

---

### WARREN COUNTY

<u>City/Twp.</u>	<u>FIPS</u>	<u>City/Twp.</u>	<u>FIPS</u>	<u>City/Twp.</u>	<u>FIPS</u>
Carlisle	12168	Corwin	18840	Franklin	28476
Harveysburg	34384	Lebanon	42364	Loveland	45108
Maineville	46872	Mason	48188	Middletown	49840
Monroe	51310	Morrow	52374	Pleasant Plain	63576
South Lebanon	73446	Springboro	74076	Waynesville	82418
Clear Creek Twp	15700	Deerfield Twp	21238	Franklin Twp	28490
Hamilton Twp	33068	Harlan Twp	33474	Massie Twp	48216
Salem Twp	69988	Turtle Creek Twp	77868	Union Twp	78610
Washington Twp	81690	Wayne Twp	82306		

### WASHINGTON COUNTY

<u>City/Twp.</u>	<u>FIPS</u>	<u>City/Twp.</u>	<u>FIPS</u>	<u>City/Twp.</u>	<u>FIPS</u>
Belpre	05424	Beverly	06222	Lowell	45164
Lower Salem	45220	Macksburg	46158	Marietta	47628
Matamoras	48286	Adams Twp	00338	Aurelius Twp	03072
Barlow Twp	03898	Belpre Twp	05438	Decatur Twp	21098
Dunham Twp	22918	Fairfield Twp	26096	Fearing Twp	26810
Grandview Twp	31276	Independence Twp	37268	Lawrence Twp	42196
Liberty Twp	43386	Ludlow Twp	45360	Marietta Twp	47642
Muskingum Twp	53452	Newport Twp	55356	Palmer Twp	59626
Salem Twp	70002	Warren Twp	80934	Waterford Twp	81774
Watertown Twp	81844	Wesley Twp	82838		

# Ohio Bridge Inventory Guide

---

## WAYNE COUNTY

<u>City/Twp.</u>	<u>FIPS</u>	<u>City/Twp.</u>	<u>FIPS</u>	<u>City/Twp.</u>	<u>FIPS</u>
Apple Creek	02232	Burbank	10254	Congress	18308
Creston	19344	Dalton	19974	Doylestown	22568
Fredericksburg	28616	Marshallville	48048	Mt Eaton	52682
Norton	57260	Orrville	58828	Rittman	67356
Shreve	72396	Smithville	72788	West Salem	84196
Wooster	86548	Baughman Twp	04276	Canaan Twp	11276
Chester Twp	14044	Chippewa Twp	14240	Clinton Twp	16224
Congress Twp	18322	East Union Twp	24136	Franklin Twp	28504
Green Twp	31878	Milton Twp	50666	Paint Twp	59556
Plain Twp	62995	Salt Creek Twp	70198	Sugar Creek Twp	75231
Wayne Twp	82320	Wooster Twp	86562		

## WILLIAMS COUNTY

<u>City/Twp.</u>	<u>FIPS</u>	<u>City/Twp.</u>	<u>FIPS</u>	<u>City/Twp.</u>	<u>FIPS</u>
Alvordton	01588	Blakeslee	06810	Bryan	09792
Edgerton	24486	Edon	24640	Holiday City	35864
Montpelier	51772	Pioneer	62834	Stryker	75140
W Unity	84308	Brady Twp	08140	Bridgewater Twp	08630
Center Twp	13008	Florence Twp	27530	Jefferson Twp	38864
Madison Twp	46634	Mill Creek Twp	50302	Northwest Twp	57162
Pulaski Twp	64920	Saint Joseph Twp	69638	Springfield Twp	74131
Superior Twp	75819				

## Ohio Bridge Inventory Guide

---

### WOOD COUNTY

<u>City/Twp.</u>	<u>FIPS</u>	<u>City/Twp.</u>	<u>FIPS</u>	<u>City/Twp.</u>	<u>FIPS</u>
Bairdstown	03646	Bloomdale	07062	Bowling Green	07972
Bradner	08112	Custar	19750	Cygnets	19820
Fostoria	28014	Grand Rapids	31206	Haskins	34412
Hoytville	36568	Jerry City	39074	Luckey	45332
Millbury	50260	Milton Center	50708	N Baltimore	56154
Northwood	57190	Pemberville	61504	Perrysburg	62148
Portage	64108	Rising Sun	67314	Rossford	68686
Tontogany	77070	W Millgrove	83888	Walbridge	80486
Wayne	82334	Weston	83972	Bloom Twp	07020
Center Twp	13015	Freedom Twp	28756	Grand Rapids Twp	31220
Henry Twp	34986	Jackson Twp	38164	Lake Twp	41328
Liberty Twp	43400	Middleton Twp	49812	Milton Twp	50680
Montgomery Twp	51744	Perry Twp	62106	Perrysburg Twp	62162
Plain Twp	63002	Portage Twp	64122	Troy Twp	77630
Washington Twp	81704	Webster Twp	82544	Weston Twp	83986

### WYANDOT COUNTY

<u>City/Twp.</u>	<u>FIPS</u>	<u>City/Twp.</u>	<u>FIPS</u>	<u>City/Twp.</u>	<u>FIPS</u>
Carey	12112	Harpster	33656	Kirby	40558
Marseilles	47992	Nevada	53942	Sycamore	75980
Nevada	53942	Sycamore	75980	Upper Sandusky	79044
Wharton	84574	Antrim Twp	02190	Crane Twp	19190
Crawford Twp	19246	Eden Twp	24360	Jackson Twp	38178
Marseilles Twp	48006	Mifflin Twp	50106	Pitt Twp	62904
Richland Twp	66782	Ridge Twp	66992	Salem Twp	70016
Sycamore Twp	75987	Tymochtee Twp	78141		

# Ohio Bridge Inventory Guide

## APPENDIX C – Ohio Structure Type Coding

The following list of structure type code combinations established in accordance with the three (3) digit coding scheme shown in Items 43A, 43B, and 43C; and 44A, 44B and 44C includes a word description for the bridge type opposite each code shown. All bridges inventoried must be type coded using the applicable code combination from this list. Code combinations not shown may not be used as they will be cause as an error in the system.

Ohio Code	Material	Type	Description	FHWA Code	Material Description	Design/Construction
000	Other	Other	Other	000	Other	Other
053	Other	Arch	Deck	011	Other	Arch - Deck
054	Other	Arch	Thru	012	Other	Arch - Thru
095	Other	Culvert	Filled	019	Other	Culvert
100	Concrete	Other	Other	100	Concrete	Other
110	Concrete	Slab	Other	101	Concrete	Slab
111	Concrete	Slab	Simple	101	Concrete	Slab
112	Concrete	Slab	Continuous	201	Concrete Continuous	Slab
120	Concrete	Beam	Other	102	Concrete	Multi-beam or Girder
121	Concrete	Beam	Simple	102	Concrete	Multi-beam or Girder
122	Concrete	Beam	Continuous	202	Concrete Continuous	Multi-beam or Girder
131	Concrete	Box Beam	Simple	105	Concrete	Box Beam or Girders - Multiple
132	Concrete	Box Beam	Continuous	205	Concrete Continuous	Box Beam or Girders - Multiple
153	Concrete	Arch	Deck	111	Concrete	Arch - Deck
154	Concrete	Arch	Thru	112	Concrete	Arch - Thru
160	Concrete	Girder	Other	103	Concrete	Girder and Floor System
163	Concrete	Girder	Deck	103	Concrete	Girder and Floor System
164	Concrete	Girder	Thru	103	Concrete	Girder and FloorSystem
170	Concrete	Frame	Other	107	Concrete	Frame

## Ohio Bridge Inventory Guide

Ohio Code	Material	Type	Description	FHWA Code	Material Description	Design/Construction
171	Concrete	Frame	Simple	107	Concrete	Frame
172	Concrete	Frame	Continuous	207	Concrete Continuous	Frame
195	Concrete	Culvert	Filled	119	Concrete	Culvert
200	Prestressed Concrete	Other	Other	500	Prestressed Concrete	Other
210	Prestressed Concrete	Slab	Other	501	Prestressed Concrete	Slab
211	Prestressed Concrete	Slab	Simple	501	Prestressed Concrete	Slab
212	Prestressed Concrete	Slab	Continuous	601	Prestressed Concrete Continuous	Slab
220	Prestressed Concrete	Beam	Other	502	Prestressed Concrete	-Multi-beam or Girder
221	Prestressed Concrete	Beam	Simple	502	Prestressed Concrete	-Multi-beam or Girder
222	Prestressed Concrete	Beam	Continuous	602	Prestressed Concrete Continuous	-Multi-beam or Girder
230	Prestressed Concrete	Box Beam	Other	521	Prestressed Concrete Continuous	Segmental Box Girder
231	Prestressed Concrete	Box Beam	Simple	505	Prestressed Concrete	Box Beam or Girder - Multiple
232	Prestressed Concrete	Box Beam	Continuous	605	Prestressed Concrete Continuous	Box Beam or Girder - Multiple
253	Prestressed Concrete	Arch	Deck	511	Prestressed Concrete	Arch - Deck
254	Prestressed Concrete	Arch	Thru	512	Prestressed Concrete	Arch - Thru
263	Prestressed Concrete	Girder	Deck	503	Prestressed Concrete	Girder and Floor System
272	Prestressed Concrete	Frame	Continuous	607	Prestressed Concrete Continuous	Frame



## Ohio Bridge Inventory Guide

Ohio Code	Material	Type	Description	FHWA Code	Material Description	Design/Const ruction
295	Prestressed Concrete	Culvert	Filled	519	Prestressed Concrete	Culvert
300	Steel	Other	Other	300	Steel	Other
320	Steel	Beam	Other	302	Steel	Multi-beam or Girder
321	Steel	Beam	Simple	302	Steel	Multi-beam or Girder
322	Steel	Beam	Continuous	402	Steel Continuous	Multi-beam or Girder
330	Steel	Box Beam	Other	421	Steel Continuous	Segmental Box Girder
331	Steel	Box Beam	Simple	305	Steel	Box Beam or Girder - Multiple
332	Steel	Box Beam	Continuous	405	Steel Continuous	Box Beam or Girder - Multiple
340	Steel	Truss	Other	309	Steel	Truss - Deck
343	Steel	Truss	Deck	309	Steel	Truss - Deck
344	Steel	Truss	Thru	310	Steel	Truss - Thru
347	Steel	Truss	Movable – Lift	315	Steel	Movable - Lift
348	Steel	Truss	Movable – Bascule	316	Steel	Movable - Bascule
349	Steel	Truss	Movable – Swing	317	Steel	Movable - Swing
353	Steel	Arch	Deck	311	Steel	Arch - Deck
354	Steel	Arch	Thru	312	Steel	Arch - Thru
360	Steel	Girder	Other	303	Steel	Girder and FloorSystem
363	Steel	Girder	Deck	303	Steel	Girder and FloorSystem
364	Steel	Girder	Thru	303	Steel	Girder and FloorSystem

## Ohio Bridge Inventory Guide

Ohio Code	Material	Type	Description	FHWA Code	Material Description	Design/Const ruction
366	Steel	Girder	Orthotropic	308	Steel	Orthotropic
367	Steel	Girder	Movable – Lift	315	Steel	Movable-Lift
368	Steel	Girder	Movable – Bascule	316	Steel	Movable - Bascule
369	Steel	Girder	Movable - Swing	317	Steel	Movable - Swing
370	Steel	Frame	Other	307	Steel	Frame
371	Steel	Frame	Simple	307	Steel	Frame
372	Steel	Frame	Continuous	407	Steel Continuous	Frame
380	Steel	Suspension	Other	313	Steel	Suspension
383	Steel	Suspension	Deck (Truss)	313	Steel	Suspension
384	Steel	Suspension	Thru	313	Steel	Suspension
395	Steel	Culvert	Filled	319	Steel	Culvert
400	Timber	Other	Other	700	Timber	Other
411	Timber	Slab	Simple	701	Timber	Slab
412	Timber	Slab	Continuous	701	Timber	Slab
421	Timber	Beam	Simple	702	Timber	Multi-beam or Girder
422	Timber	Beam	Continuous	702	Timber	Multi-beam or Girder
443	Timber	Truss	Deck	709	Timber	Truss - Deck
444	Timber	Truss	Thru	710	Timber	Truss - Thru
453	Timber	Arch	Deck	711	Timber	Arch - Deck
454	Timber	Arch	Thru	712	Timber	Arch - Thru
463	Timber	Girder	Deck	703	Timber	Girder and Floor System
464	Timber	Girder	Thru	703	Timber	Girder and Floor System
470	Timber	Frame	Other	707	Timber	Frame
471	Timber	Frame	Simple	707	Timber	Frame
472	Timber	Frame	Continuous	707	Timber	Frame
483	Timber	Suspension	Deck	713	Timber	Suspension
495	Timber	Culvert	Filled	719	Timber	Culvert
500	Stone	Other	Other	800	Masonry	Other
553	Stone	Arch	Deck	811	Masonry	Arch - Deck

## Ohio Bridge Inventory Guide

Ohio Code	Material	Type	Description	FHWA Code	Material Description	Design/Const ruction
595	Stone	Culvert	Filled	819	Masonry	Culvert
600	Aluminum	Other	Other	900	Aluminum, Wrought Iron, Cast Iron	Other
621	Aluminum	Beam	Simple	902	Aluminum, Wrought Iron, Cast Iron	Multi-beam or Girder
622	Aluminum	Beam	Continuous	902	Aluminum, Wrought Iron, Cast Iron	Multi-beam or Girder
643	Aluminum	Truss	Deck	909	Aluminum, Wrought Iron, Cast Iron	Truss-Deck
644	Aluminum	Truss	Thru	910	Aluminum, Wrought Iron, Cast Iron	Truss - Thru
653	Aluminum	Arch	Deck	911	Aluminum, Wrought Iron, Cast Iron	Arch - Deck
654	Aluminum	Arch	Thru	912	Aluminum, Wrought Iron, Cast Iron	Arch - Thru
671	Aluminum	Frame	Simple	907	Aluminum, Wrought Iron, Cast Iron	Frame
695	Aluminum	Culvert	Filled	919	Aluminum, Wrought Iron, Cast Iron	Culvert
700	Cast Iron	Other	Other	900	Aluminum, Wrought Iron, Cast Iron	Other

## Ohio Bridge Inventory Guide

Ohio Code	Material	Type	Description	FHWA Code	Material Description	Design/Construction
721	Cast Iron	Beam	Simple	902	Aluminum, Wrought Iron, Cast Iron	Multi-beam or Girder
722	Cast Iron	Beam	Continuous	902	Aluminum, Wrought Iron, Cast Iron	Multi-beam or Girder
743	Cast Iron	Truss	Deck	909	Aluminum, Wrought Iron, Cast Iron	Truss – Deck
744	Cast Iron	Truss	Thru	910	Aluminum, Wrought Iron, Cast Iron	Truss – Thru
747	Cast Iron	Truss	Movable – Lift	912	Aluminum, Wrought Iron, Cast Iron	Movable – Lift
748	Cast Iron	Truss	Movable - Bascule	916	Aluminum, Wrought Iron, Cast Iron	Movable – Bascule
749	Cast Iron	Truss	Movable – Swing	917	Aluminum, Wrought Iron, Cast Iron	Movable – Swing
753	Cast Iron	Arch	Deck	911	Aluminum, Wrought Iron, Cast Iron	Arch - Deck
754	Cast Iron	Arch	Thru	912	Aluminum, Wrought Iron, Cast Iron	Arch - Thru
771	Cast Iron	Frame	Simple	907	Aluminum, Wrought Iron, Cast Iron	Frame

## Ohio Bridge Inventory Guide

Ohio Code	Material	Type	Description	FHWA Code	Material Description	Design/Construction
772	Cast Iron	Frame	Continuous	907	Aluminum, Wrought Iron, Cast Iron	Frame
795	Cast Iron	Culvert	Filled	919	Aluminum, Wrought Iron, Cast iron	Culvert
800	Wrought Iron	Other	Other	900	Aluminum, Wrought Iron, Cast Iron	Other
843	Wrought Iron	Truss	Deck	909	Aluminum, Wrought Iron, Cast Iron	Truss-Deck
844	Wrought Iron	Truss	Thru	910	Aluminum, Wrought Iron, Cast Iron	Truss - Thru
847	Wrought Iron	Truss	Movable-Lift	915	Aluminum, Wrought Iron, Cast Iron	Movable-Lift
848	Wrought Iron	Truss	Movable-Bascule	919	Aluminum, Wrought Iron, Cast Iron	Movable-Bascule
849	Wrought Iron	Truss	Movable-Swing	917	Aluminum, Wrought Iron, Cast Iron	Movable-Swing
853	Wrought Iron	Arch	Deck	911	Aluminum, Wrought Iron, Cast Iron	Arch - Deck
854	Wrought Iron	Arch	Thru	912	Aluminum, Wrought Iron, Cast Iron	Arch - Thru

## Ohio Bridge Inventory Guide

Ohio Code	Material	Type	Description	FHWA Code	Material Description	Design/Construction
860	Wrought Iron	Girder	Other	903	Aluminum, Wrought Iron, Cast Iron	Girder and Floor System
863	Wrought Iron	Girder	Deck	903	Aluminum, Wrought Iron, Cast Iron	Girder and FloorSystem
867	Wrought Iron	Girder	Movable – Lift	915	Aluminum, Wrought Iron, Cast Iron	Movable – Lift
868	Wrought Iron	Girder	Movable – Bascule	916	Aluminum, Wrought Iron, Cast Iron	Movable – Bascule
869	Wrought Iron	Girder	Movable - Swing	917	Aluminum, Wrought Iron, Cast Iron	Movable - Swing
895	Wrought Iron	Culvert	Filled	919	Aluminum, Wrought Iron, Cast Iron	Culvert
911	Composite	Slab	Simple	001	Other	Slab
912	Composite	Slab	Continuous	001	Other	Slab
921	Composite	Beam	Simple	002	Other	Multi-beam or Girder
922	Composite	Beam	Continuous	002	Other	Multi-beam or Girder
971	Composite	Frame	Simple	007	Other	Frame
972	Composite	Frame	Continuous	007	Other	Frame
995	Composite	Culvert	Filled	019	Other	Culvert
1A4	Concrete	Cable Stayed	Thru	214	Concrete Continuous	Stayed Girder
34A	Steel	Truss	Pony	310	Steel	Truss-Thru
3A4	Steel	Cable Stayed	Thru	314	Steel	Stayed Girder

## Ohio Bridge Inventory Guide

---

Ohio Code	Material	Type	Description	FHWA Code	Material Description	Design/Construction
64A	Aluminum	Truss	Pony	910	Aluminum, Wrought Iron, Cast Iron	Truss-Thru

## APPENDIX D – Substructure - Abutments & Piers

Semi-Integral Abutments – Consider the portion above the horizontal form line as a diaphragm or crossframe. The abutment wall is below the bottom flange of the beam. The abutment is located below the form line or polystyrene. Bearings should be rated for semi-integral. Inspect what you see AND allow indications of deficiencies to influence a lower condition rating when the unseen item is directly affected.



Figure 88 - Semi-Integral Abutment

Integral Abutments – Do not have bearings or abutment caps. Consider the portion above the horizontal form line as a diaphragm or crossframe. The abutment wall is below the bottom flange of the beam.

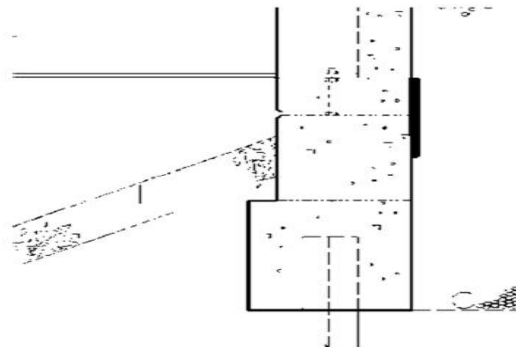

Figure 89 - Integral Abutment



# Ohio Bridge Inventory Guide

---



Figure 91 - Steel Capped Bent Abutment with Timber Lagging



Figure 92 - Pier Wall

# Ohio Bridge Inventory Guide

---



Figure 93 - Capped Bile Bent

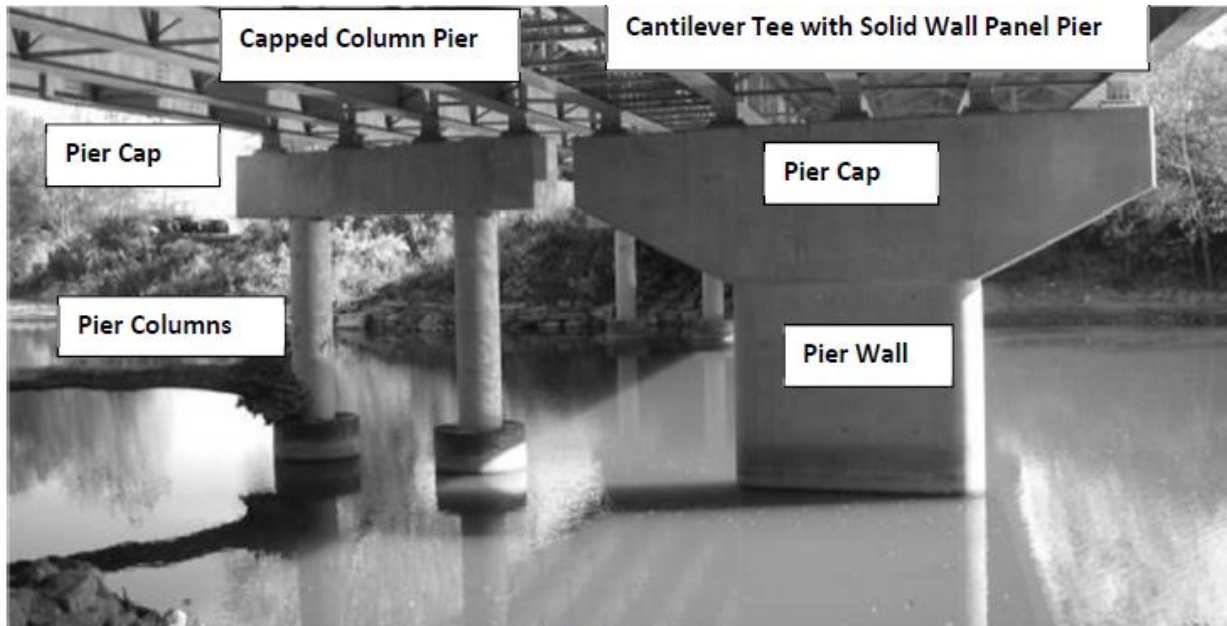

Figure 94 - Concrete Capped Column and Hammerhead Cantilever Pier

# Ohio Bridge Inventory Guide

---

**Full Height Wall vs. Stub Wall**– Full height, stub (breast wall is generally less than or equal to 4')



Figure 86 - Full Height Abutment



Figure 87 - Stub Abutment

### **APPENDIX E – Ohio Item 248 Original Construction Project Number**

- A. Structures sold an originally built under a Project Number. Code the project number in the first four (4) positions of the item, right justified and using leading zeros where necessary. Code the last two (2) digits of the year in which the project was sold in the last two (2) positions of the item.
- B. Structures built by Force Account (by Agency Forces). Code the capital letters “FA” in the third and fourth character position of the item and code the last two (2) digits of the year in which the structure was built in the last (2) positions of the item.
- C. Structures built by non-state agencies, including those built by States other than Ohio and those constructed under private contracts. Code an alphabetic abbreviation to represent the agency that constructed that bridge using all capital letters. A combination of alphabetic and numeric characters may be used in this item to identify specific contracts by an agency. Numerals, if used, may only be coded in the first four (4) character positions. Coded abbreviations using less than six (6) characters must be right justified and filled with leading zeros. See below for suggested abbreviation standards.
- D. Structures built by State agencies other than the Department of transportation, such as the Ohio Turnpike Commission, the Conservancy Districts, the Department of Natural Resources, etc., should code a contract or project number using that agency’s scheme of alphabetic and/or numeric characters. If such a number is not available or impractical, code an abbreviation following the scheme described in Part “C” above. See below for suggested standards.
- E. Structures for which either incomplete or no information is available. Code the key word “UNKNWN” in the item. Although it is recommended that all records submitted include the information required in this item non-state agencies (Counties, municipalities, etc.) are not require3d to code the item. If these agencies decide to code the information, a uniform individualized system should be adopted by an agency. If an agency has a bridge that was sold through ODOT “Contract Sales”, they should code the item for the bridge as described

# Ohio Bridge Inventory Guide

---

## **Suggested Standard Coding for Ohio Original Construction Project Numbers**

The following list of abbreviations includes those for non-state and other (non-DOT) State agencies most commonly involved. For agencies not listed, it will be necessary for the coder to create his own abbreviation using the same logic and being careful not to cause confusion by duplicating those shown in this list.

<b>NONE-STATE AGENCY CONSTRUCTION</b>	
<b><u>Structure built by</u></b>	<b><u>Code</u></b>
Federal Public Work Programs such as "WPA" and "CCC"	"000FPW"
County Construction not sold under State contract system	"COUNTY"
Army Corps of Engineers	"0000CE"
Private Contract	"0000PC"
City Construction not sold under State contract system	"000CITY"
Other State DOT (Example: Florida DOT)	"FLADOT"

<b>OTHER-STATE AGENCY CONSTRUCTION</b>	
<b><u>Structure built by</u></b>	<b><u>Code</u></b>
Ohio Turnpike Commission (Using Contract Number)	"0000TP" "0025TP"
State Public Works Program	"000SPW"
Ohio Building Authority	"0000BA"
Ohio Department of Natural Resources	"000DNR"
Ohio Bridge Commission	"0000BC"
Ohio National Guard	"000ONG"
Muskingum Conservancy District	"000MCD"

# Ohio Bridge Inventory Guide

## APPENDIX F – NBI #19 Bypass (Detour) Length

The Bypass (Detour) Length (additional travel distance) for the example show below is calculated as follows:

Length of Route being bypassed measured between detour points = 10.3 miles.

Length of Detour Route used to temporarily bypass the problem site, measured between detour points = 19.6 miles.

Bypass (Detour) length – 19.6 miles – 10.3 miles = 9.3 miles (Code 09 Miles)

### BYPASS (DETOUR) LENGTH

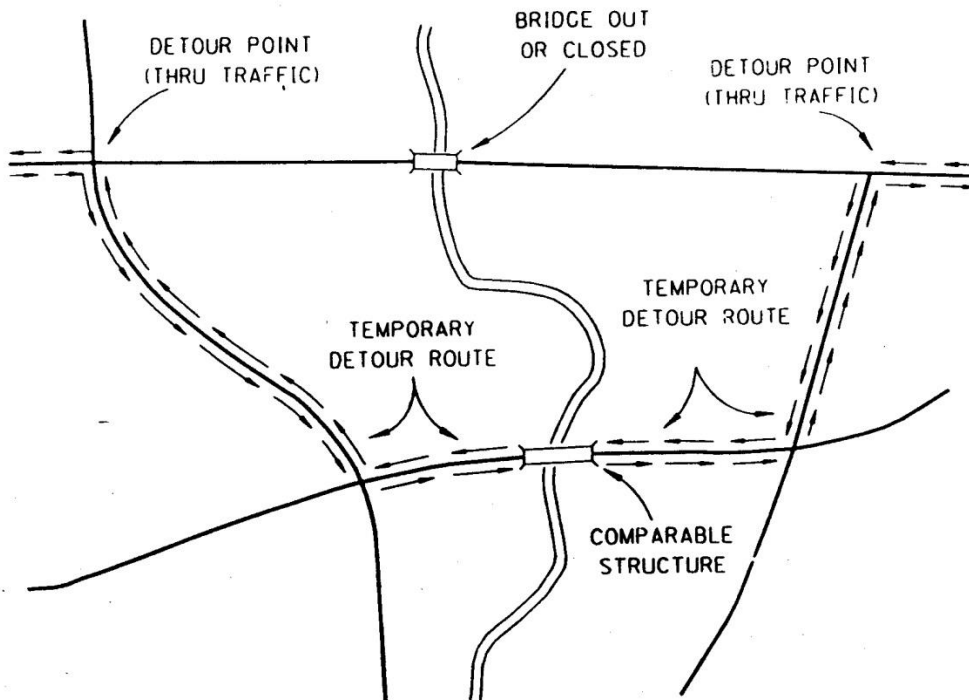

# Ohio Bridge Inventory Guide

---

## APPENDIX G – ODOT Standardized Coding for Route Number Suffix NBI Item #5D

To be coded in last digit positions only of “**ROUTE**” portion of Items 5D and 370D when a single digit suffix is required to describe an official special category route.

Suffix Code	Special Route Designation
A	Alternate
B	Bypass
C	Spur or Connector
D	Directional Alternate (1 <sup>st</sup> within County)
F	Directional Alternate (2 <sup>nd</sup> within County)
G	Directional Alternate (3 <sup>rd</sup> within County)
J	Future
T	Temporary
K	Turnpike (special code to allow differentiation between Ohio Turnpike Commission controlled IR 80 & IR 76 and ODOT controlled IR 80 & IR 76)
X	Duplicate Route (usually old route still on System after new route of same number is open to traffic)

# Ohio Bridge Inventory Guide

## APPENDIX H - Coding of Load Rating

### How to Code Load Rating of a New Bridge with No Load Rating Analysis

Item#	Description	Code	Notes
63	Operating Method of Rating	5	No rating analysis performed
64	Operating Rating	45.000	Code in tons when #63 = 5
65	Inventory Method of Rating	5	No rating analysis performed; same as #63
66	Inventory Rating	36.000	Code in tons when #65 = 5
704	Load Rating Date	9/9/2013	Do not put date in future or prior to date-built
708	Software of Rating Analysis	0	No calculations were done for load rating
709	Rating Source	1	Plans & Information available for load rating
734	Ohio Percent of Legal Loads	150	Assuming 150% for a new structure

### How to Code Load Rating of a Bridge Exempt from Load Rating per ODOT BDM

#### Section 900 (designed by LRFD Method)

Item#	Description	Code	Notes
63	Operating Method of Rating	F	Assigned ratings based on LRFR
64	Operating Rating	1.250	RF=1.25
65	Inventory Method of Rating	F	Assigned ratings based on LRFR; same as #63
66	Inventory Rating	1.000	RF=1.000
704	Load Rating Date	9/9/2016	Do not put date in future or prior to date-built
708	Software of Rating Analysis	7	Combination
709	Rating Source	1	Plans & Information available for load rating
734	Ohio Percent of Legal Loads	150	Assuming 150% for a new structure

### How to Code Load Rating of a Bridge Exempt from Load Rating per ODOT BDM

#### Section 900 (designed by LFD Method)

Item#	Description	Code	Notes
63	Operating Method of Rating	D	Assigned ratings based on LFR
64	Operating Rating	1.250	RF=1.250
65	Inventory Method of Rating	D	Assigned ratings based on LFR; same as #63
66	Inventory Rating	1.000	RF=1.000
704	Load Rating Date	9/9/2013	Do not put date in future or prior to date-built
708	Software of Rating Analysis	7	Combination
709	Rating Source	1	Plans & Information available for load rating
734	Ohio Percent of Legal Loads	150	Assuming 150% for a new structure



## Ohio Bridge Inventory Guide

---

### **How to Code Load Rating of a Bridge with Assigned Load Rating {For Culverts Designed Using ASTM C1577 (LRFD), C1433 (LFD), C789 (LFD) & C850 (LFD)}**

#### **Rating Load: HS20**

<b>Item#</b>	<b>Description</b>	<b>Code</b>	<b>Notes</b>
63	Operating Method of Rating	D	Assigned ratings based on LFR
64	Operating Rating	1.250	RF=1.250
65	Inventory Method of Rating	D	Assigned ratings based on LFR; same as #63
66	Inventory Rating	1.000	RF=1.000
704	Load Rating Date	9/9/2013	Do not put date in future or prior to date-built
708	Software of Rating Analysis	7	Combination
709	Rating Source	1	Plans & Information available for load rating
734	Ohio Percent of Legal Loads	150	Assuming 150% for a new structure

### **How to Code Load Rating of a Bridge with Assigned Load Rating {For Culverts Designed Using ASTM C1577 (LRFD), C1433 (LFD), C789 (LFD) & C850 (LFD)}**

#### **Rating Load: HL93**

<b>Item#</b>	<b>Description</b>	<b>Code</b>	<b>Notes</b>
63	Operating Method of Rating	F	Assigned ratings based on LRFR
64	Operating Rating	1.250	RF=1.250
65	Inventory Method of Rating	F	Assigned ratings based on LRFR; same as #63
66	Inventory Rating	1.000	RF=1.000
704	Load Rating Date	9/9/2013	Do not put date in future or prior to date-built
708	Software of Rating Analysis	7	Combination
709	Rating Source	1	Plans & Information available for load rating
734	Ohio Percent of Legal Loads	150	Assuming 150% for a new structure

# Ohio Bridge Inventory Guide

---

## **How to Code Load Rating of a Bridge When No Plans or Information are available for Load Rating (Also known as Good-5 Bridge)**

<b>Item#</b>	<b>Description</b>	<b>Code</b>	<b>Notes</b>
63	Operating Method of Rating	0	Field evaluation and documented
64	Operating Rating	45.000	Code in tons when #63 = 0
65	Inventory Method of Rating	0	Field evaluation and documented; same as #63
66	Inventory Rating	36.000	Code in tons when #65 = 0
704	Load Rating Date	9/9/2013	Do not put date in future or prior to date-built
708	Software of Rating Analysis	0	No calculations were done for load rating
709	Rating Source	0	No Plan & Information available for load rating
734	Ohio Percent of Legal Loads	100	100% Rated based on the Engineering Judgment

## **How to Code Load Rating of a Bridge that is posted based on field conditions**

<b>Item#</b>	<b>Description</b>	<b>Code</b>	<b>Notes</b>
63	Operating Method of Rating	0	Field evaluation and documented
64	Operating Rating	20.000	Code in tons when #63 = 0
65	Inventory Method of Rating	0	Field evaluation and documented; same as #63
66	Inventory Rating	15.000	Code in tons when #65 = 0
704	Load Rating Date	9/9/2013	Do not put date in future or prior to date-built
709	Rating Source	1	Plans & Information available for load rating
734	Ohio Percent of Legal Loads	90	90% of Ohio Legal

## **How to Code Load Rating of a Bridge under More Than 6.5 Feet (~2 meters) Of Fill**

<b>Item#</b>	<b>Description</b>	<b>Code</b>	<b>Notes</b>
63	Operating Method of Rating	D	Assigned rating based on LFR
64	Operating Rating	1.250	Maximum value of RF to be coded is 1.25
65	Inventory Method of Rating	D	Assigned rating based on LFR; same as #63
66	Inventory Rating	1.000	Inventory RF coded 70% of the Operating RF
704	Load Rating Date	9/9/2013	Do not put date in future or prior to date-built
708	Software of Rating Analysis	7	Combination
709	Rating Source	1	Plans & Information available for load rating
734	Ohio Percent of Legal Loads	150	Assuming 150% for a new structure

# Ohio Bridge Inventory Guide

---

## **How to Code Load Rating of a Bridge That Is Rated 100% Legal or Above but the Engineer Wants to Post It**

<b>Item#</b>	<b>Description</b>	<b>Code</b>	<b>Notes</b>
63	Operating Method of Rating	0	Field evaluation and documented
64	Operating Rating	25.000	Code in tons when #63 = 0
65	Inventory Method of Rating	0	Field evaluation and documented; same as #63
66	Inventory Rating	18.000	Code in tons when #65 = 0
704	Load Rating Date	9/9/2013	Do not put date in future or prior to date-built
709	Rating Source	1	Plans & Information available for load rating
734	Ohio Percent of Legal Loads	90	If the Engineer wants to post it at, say 90%

## **How to Code Load Rating of a Bridge That Is Rated Below 100% Legal But the Engineer Does not Want to Post It**

<b>Item#</b>	<b>Description</b>	<b>Code</b>	<b>Notes</b>
63	Operating Method of Rating	0	Field evaluation and documented
64	Operating Rating	36.000	Code in tons when #63 = 0
65	Inventory Method of Rating	0	Field evaluation and documented; same as #63
66	Inventory Rating	27.000	Code in tons when #65 = 0
704	Load Rating Date	9/9/2013	Do not put date in future or prior to date-built
709	Rating Source	1	Plans & Information available for load rating
734	Ohio Percent of Legal Loads	100	100% of Ohio Legal

## **How to Code Load Rating of a Bridge based on load testing**

<b>Item#</b>	<b>Description</b>	<b>Code</b>	<b>Notes</b>
63	Operating Method of Rating	4	Load testing
64	Operating Rating	30.000	Code in tons when #63 = 4
65	Inventory Method of Rating	4	Load testing; same as #63
66	Inventory Rating	20.000	Code in tons when #65 = 4
704	Load Rating Date	9/9/2013	Do not put date in future or prior to date-built
709	Rating Source	1	Plans & Information available for load rating
734	Ohio Percent of Legal Loads	100	100% of Ohio Legal