

Novel Sensors for Monitoring Acoustic Cavitation

Bajram Zeqiri, Steve C. Davies, Pierre N. Gelat,
Mark Hodnett and Usman I. Lula
Centre for Mechanical and Acoustical Metrology, National Physical
Laboratory
Queens Road, Teddington, Middlesex, TW11 0LW
United Kingdom.*

Abstract – This paper describes a novel acoustic sensor of potential application in monitoring cavitation occurring within ultrasonic cleaning vessels. The sensors, fabricated in the form of hollow cylinders, are manufactured from a thin (110 mm) piezoelectric polymer whose acoustic bandwidth (10 MHz) is sufficient to detect the high-frequency signals generated by cavitating bubble collapse. One of the key characteristics of the sensors is their spatial resolution: acoustic signals detected at high frequencies originate from bubble events occurring within the hollow cylinder itself. To isolate these, the cavitation sensors are encapsulated in a 4 mm thick layer of a specially-developed acoustical absorber acting as a shield to bubble events occurring outside of the sensor volume. The construction of the new sensor is described, and early results of its response in the acoustic field of an ultrasonic cleaning vessel are presented.

(The novel sensors described in this paper are covered under a UK Patent Priority Application No. 9921982.6).

I. INTRODUCTION

Even though the application of ultrasonic cleaning technology is widespread, standardised procedures for assessing

the cleaning performance have been extremely difficult to establish [1]. One mechanism believed to play a key role in cleaning is acoustic cavitation. Acoustic cavitation may be described as the oscillation and implosion of small stabilized gas bubbles within a fluid medium. Despite the crucial role played by cavitation, there are currently no accepted methods for quantifying the 'amount' of cavitation occurring. In a recent worldwide survey of equipment manufacturers and users, a strong requirement for such techniques was identified [2]. Furthermore, establishing reliable and validated sensors was seen as essential in underpinning the development of such methods.

Methods which have been applied to monitor cavitation, usually involve measuring the direct effects of cavitation, such as light emission, free-radical generation and erosion [3]. It is also well documented that, in response to a forcing acoustic field, bubbles act as secondary acoustic sources whose emission spectra contain distinct features intimately related to the dynamics of bubble motion. One feature is the broadband continuum noise which is commonly associated

©2000 IEEE. Reprinted with permission from 2000 IEEE Ultrasonics Proceedings, Volume 1, pp417-420.

UIA Sustaining Members

APC International, Ltd.
Branson Ultrasonics Corp.
Bullen Ultrasonics, Inc.
Crest Ultrasonics
Dentsply International
Dukane Corporation

Eastman Kodak Company
EDO Corporation, Acoustics Div.
Ethicon Endo-Surgery Inc.
Greer Manufacturing, Inc.
Lewis Corporation
Misonix, Inc.

Morgan Electroceramics, Inc.
Piezo Kinetics, Inc.
Piezotech, LLC
Sonics & Materials, Inc.
Sonic Systems
Sonicor Instrument Corp.

Sonobond Ultrasonics
Spemby Medical Limited
Stapla Ultrasonics Corporation
Staveley Sensors, Inc.
Tecnea Engineering S.R.L.
Telsonic Ultrasonics
Valleylab, Inc.
Zevex, Inc.

with the onset of violent inertial cavitation [3]. This paper describes a new type of passive acoustic sensor, designed to monitor high frequency acoustic signals generated by cavitation.

II. Sensor Concept

A number of desirable features of any cavitation sensor can be defined. It should:-

- be as unperturbing as possible to the direct acoustic field generated by the cleaning vessel;
- possess a wide measurement bandwidth, extending into the MHz region, enabling it to detect the broadband acoustic energy generated by the bubble collapse;
- be based on a focussed receiver concept, so that the acoustic energy monitored from the bubble collapse can be associated with a specific volume of the fluid, providing the sensor with spatial resolution.

III. Sensor Realisation

A schematic of the developed cavitation sensor is shown in figure 1. It consists of a hollow right-circular cylinder of

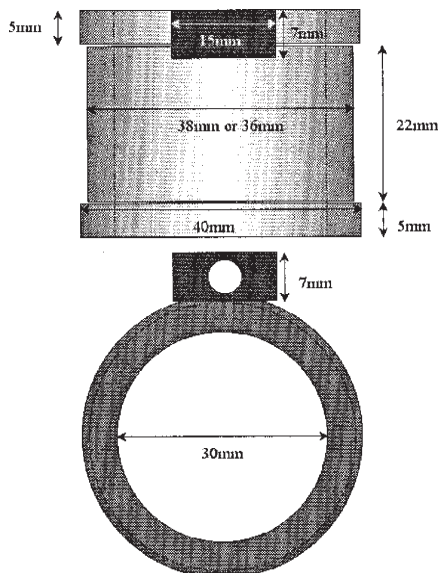

Figure 1: Schematic representation of the cavitation sensor, based on a hollow cylinder of inside diameter 30 mm and height 32 mm, which is shrouded in a 4 mm thick layer of the cavitation shield material. The 15 mm x 7 mm x 7 mm lug on the side of the cylinder is provided for mounting purposes.

internal diameter 30 mm, made from an inner strip of piezo-electric polymer film, acting as a passive acoustic receiver. The film thickness of 110 micron, has a theoretical resonance at of 9 MHz, providing it with a response at the frequencies of interest. The piezo-film is encapsulated in a 4 mm thick layer of a polymeric material which will be referred to hereafter as a cavitation shield. A special moulding tool has been developed to enable the one-piece cavitation shield material to be deposited on the outside of the acoustic sensor. Electrical contacts are either partially or totally imbedded within the cavitation shield material. The measured capacitance of the sensors is typically 2.2 nF, close to the theoretical value.

IV. Cavitation Shield Properties

The main function of the cavitation shield layer is to ensure that high frequency acoustic signals contributing to the electrical output signal of the sensor originate from the fluid contained within the sensor. As such, desirable properties of the material are that its attenuation coefficient must be:-

- exceedingly high at MHz frequencies;
- kept to a minimum at the driving frequency of the cleaning vessel, 40 kHz.

Details of the composition of the cavitation shield material, which were developed under a specialist development programme, are proprietary. They are, however, based on a polyurethane rubber, whose properties of attenuation coefficient and acoustic impedance have been optimized for the application. In particular, the acoustic impedance at 40 kHz has been adjusted to match that of water. Above 1.5 MHz, the transmission loss of the material is 65 dB cm⁻¹ MHz⁻¹. Therefore, for frequencies above 1.5 MHz, the 4 mm layer of shield material will attenuate signals originating outside the cylinder by at least 40 dB, relative to those occurring within the sensor volume. This degree of attenuation increases very rapidly with frequency. The cavitation shield material also gives the cylindrical sensors a significant degree of rigidity.

V. Experimental Systems

Sensor test bed

The performance evaluation of the new cavitation sensors was carried out using a BRANSON Ultrasonics 6465-126-12CB cleaning vessel, operating at a frequency of 40 kHz, in conjunction with a B8040-12 generator. The generator had

Novel Sensors for Monitoring Acoustic Cavitation . . . cont.

been modified to allow the electrical drive to be precisely and reproducibly varied over the range 5% to 100% of the full rated power of the cleaning vessel (1 kW). A water management system allows water of a specified purity (5 micron filter) and dissolved oxygen content (<0.5 ppm) to be used within the vessel.

Spectrum Analyser

The spectral content of the sensor signals was determined using a Hewlett Packard 3589A Spectrum analyzer. Although various set-up conditions were used for the measurements shown in Section VI, they were typically characterised by between 5 and 50 averages of the frequency sweep.

VI. Experimental Results

Prior to the design and development of the mould tool for fabricating the sensor, feasibility studies were carried out on the basic sensor concept. This involved comparing acoustic spectra generated from the 'bare' piezo-electric film, with spectra obtained from the film when shrouded in a cylinder of the cavitation shield. The results below have been derived using the cleaning vessel filled with air saturated 'tap-water' at room temperature (20°C).

Figure 2 shows the comparison of the acoustic spectra depicted up to a frequency of 400 kHz, with the cleaning vessel operating at 20% of maximum power. The vertical scale has been greatly expanded to show those frequency components occurring between the well-defined harmonics, which occur at multiples of the fundamental drive frequency of the vessel. Of interest within the current paper is the fact

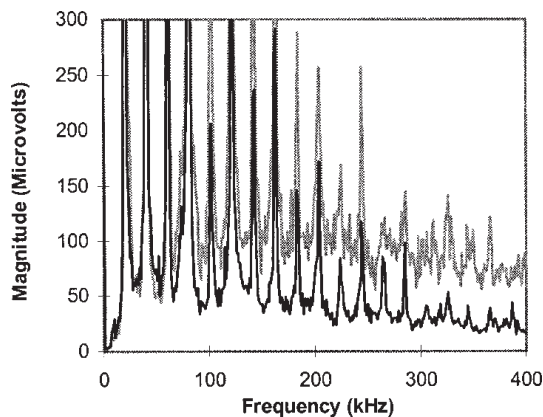

Figure 2: Comparison of sensor spectra derived from a) 'bare' piezo-electric film (grey plot) and b) the same film, placed in a 30 mm diameter hollow cylinder of the cavitation shield material (black plot). The two configurations have been positioned at nominally identical positions within the cleaning vessel which has been filled with air-saturated 'tap water'. The vessel was operating at 20% of its maximum output power.

that at progressively lower frequencies, the two spectra are virtually indistinguishable. This indicates that the cavitation shield material is indeed reasonably un-perturbing below 50 kHz. At progressively higher frequencies, the signal levels generated by the sensor, when placed in the cavitation shield cylinder are significantly lower, due to the increasing absorption coefficient of the shield material.

Figure 3, examines the high frequency range, covering 1 to 15 MHz (frequency resolution 35 kHz), where spectra are again compared for the two situations given above. It should be noted that the existence of acoustic signals at frequencies in excess of 10 MHz has been confirmed through measurements made using a wide-bandwidth Marconi bilaminar membrane hydrophone, and these results are given as a third curve in figure 3. It is clear from figure 3, that the signal levels above 1 MHz are greatly reduced when the piezo-film sensor is in the shielded configuration. This arises due to the spatial resolution of the new sensor, so that only bubble events occurring within the cylinder contribute to the high frequency (above 1.5 MHz) sensor output. In contrast, in the un-shielded (or 'bare' configuration), events occurring throughout the cleaning vessel potentially contribute to the sensor output.

It is clearly of interest to establish how the high frequency acoustic spectra generated by the sensor vary with the nominal electrical power delivered to the ultrasonic cleaning vessel. Figure 4 shows this dependence derived from one of a number of final encapsulated sensors fabricated for the purposes of performance evaluation. The specific spectra shown in figure 4 were derived from measurements made in degassed-deionised water characterised by a dissolved oxygen content of 3.36 ppm and a temperature of 20.1 °C.

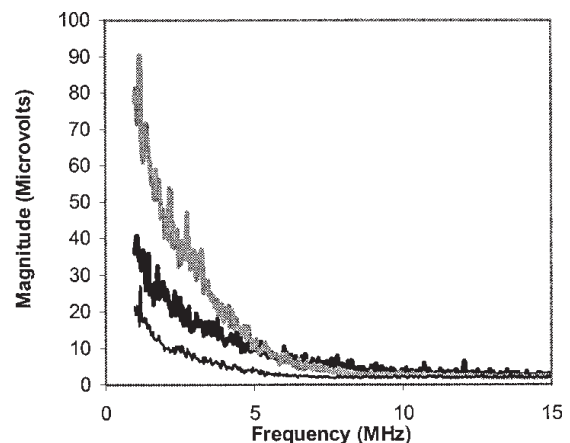

Figure 3: Comparison of sensor spectra derived from a) 'bare' piezo-electric film (grey) and b) the same film, placed in a 30 mm diameter hollow cylinder of the cavitation shield material (fine black). Also presented is the response generated by a wide band-width Marconi bilaminar membrane hydrophone (heavy black). The experimental conditions are the same as those in figure 2.

Novel Sensors for Monitoring Acoustic Cavitation . . . cont.

The sensor was placed centrally within the cleaning vessel and spectral acquisitions carried out as the vessel power was gradually increased from the minimum level of 5% up to the 95% of the maximum output power of the vessel. The results shown in Figure 4 are for a single sensor, but they are typical of a number of measurement runs carried out using different sensors, as well as repeat measurements made using the same sensor placed at nominally identical positions within the cleaning vessel.

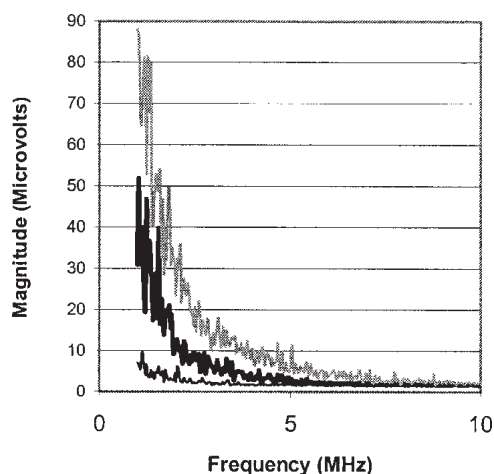

Figure 4: Frequency spectra generated at three power settings of the BRANSON cleaning vessel: 5% (fine black); 40% (heavy black) and 95% (fine grey). Spectra are shown over the frequency range 1 to 10 MHz.

It is clear from figure 4 that there is a strong and systematic increase in the MHz frequency signal levels as the output power setting of the cleaning vessel is increased. The 1 MHz signal level increases by approximately 20 dB, from 5% to 95%. The spectra are characterised by energy progressively being transferred to higher frequencies as the vessel output power is increased. For the 95% case, for example, signals at 8 MHz are just about distinguishable from the noise floor of the measurement system. This is the expected behaviour for a strongly nonlinear system such as a bubble, driven at increasingly high forcing pressures [4].

VII. Summary

This paper has introduced a new type of passive acoustic sensor designed to monitor the broadband emissions generated by acoustic cavitation.

The characteristics of the sensors are as follows:

- the measurement bandwidth of the sensors is in excess of 10 MHz, enabling the MHz frequency signals generated by violent inertial cavitation to be monitored;
- a cavitation shield resident on the outside of the hollow cylindrical sensors ensures that contributing MHz signals originate from within the sensor itself, providing the sensors with spatial resolution.

Early tests to establish the 'proof-of-concept' have been encouraging and it is anticipated that the major potential application area for the sensor is as a monitoring tool for assessing cavitation activity occurring with ultrasonic cleaning vessels.

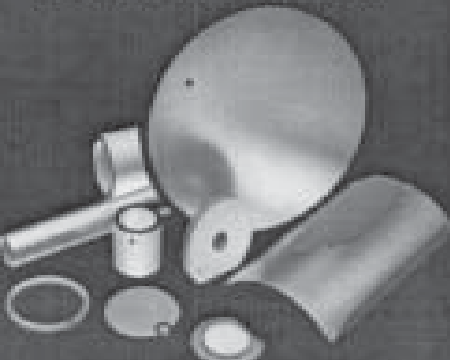
<p>PIEZO CERAMIC PRODUCTS</p> <ul style="list-style-type: none">• Air Transducers• Piezo Buzzers• Gas Igniters• Disk Benders• Fluid Atomizers• Alumina Ceramics• Single Crystals• Actuators• Piezo Powders <p>APC ((3)) International, Ltd.</p>	<p>PIEZO CERAMICS</p>  <p>American Piezo Ceramics, Inc. Duck Run, P.O. Box 190, Mackeyville, PA 17750 USA Phone #: +570-726-6961, Fax #: +570-726-7468 e-mail: APCSales@aol.com www.americanpiezo.com</p>
---	--

VIII. Acknowledgments

The development of these novel sensors was funded under the NPL Strategic Research Programme, project 9SRP3020.

IX. References

- [1] International Electrotechnical Commission Technical Report IEC 60886: 1987. Investigations on test procedures for ultrasonic cleaners.
- [2] Zeqiri, B, Hodnett, M and Leighton, T G, 1997. A strategy for the development and standardisation of measurement methods for high power/cavitating ultrasonic fields – Final Project Report. NPL Report CIRA(EXT)016.
- [3] Timothy G Leighton, The Acoustic Bubble, Academic Press, London, 1994.
- [4] Ilyichev, VI, Koretz, VL and Melnikov, NP. Spectral characteristics of acoustic cavitation. *Ultrasonics*, 1989; 27: 357 - 361.



Are you looking for answers that will give your company more profitable results?

With Ainslie as your Quality consultant, you are better equipped to produce the right product at the right time and for the right price.

Ainslie offers:

- Facility Surveys & Audits
- Planning & Implementation
- Documentation Preparation
- ISO/FDA Assessment Preparation
- Training Courses
- Product Marketing Guidance
- Product & Patent Evaluations

Find out how a *Cost Effective Business System* can help expand your business. Contact:

AINSLIE

27 Pine Ridge Road Larchmont, NY 10538 USA

Alan Broadwin, CQA RAC Principal

RAB Auditor in USA & IQA Assessor in EU

Tel: 914-833-2649 Fax: 914-833-5037

e-mail: broadwin@ainslie.com

WHEN IT COMES TO

Plastics Joining Technology

Ultrasonic, Linear and Orbital Vibration, Hot Plate, Spin, and Laser Welding • Worldwide Sales and Technical Support • Proven Performance and Reliability • Superior Value for Your Investment • Educational Seminars, at Our Facility or Yours

NOBODY KNOWS IT LIKE

BRANSON

41 Eagle Road, Danbury, CT 06813-1961
(203) 796-0349 Fax (203) 796-0030
www.Branson-PlasticsJoin.com

Ultrasound is our one and only business.



EBL Lead Zirconate Titanates

Performance, Quality and Service for Every Application

- Wide Variety of Material Types
- Low Minimum Order/No Lot Charges
- 100% Inspection
- Precision Tolerances Invited

EBL Piezoceramic Tubes

For Ultra precise Positioning Applications

- Ideal for STM/APM
- Wide Variety of Piezo Materials
- Unlimited Electrode Configurations
- Custom Designs Invited

EBL Matching Layers & Wearplates

Optimize Ultrasonic Transducer Performance

- (1/4) Layers for Enhanced Efficiency and Bandwidth
- Proprietary Composition Epoxies
- Durable Wearplates for NDT Transducers

STANTLEY SENSORS - INC

81 PRISTINE PLAZA CIRCLE, 1 HARTFORD, CT. 06180 TELEPHONE: 860-238-6271



Editor's Note

Editor's Note

This is the first issue of *Vibrations* to be published since the 31st Annual UIA Symposium in October 2001. The Symposium came soon after another significant event, the triple tragedies of the World Trade Center, Pentagon, and Flight 93 on September 11, 2001.

The UIA is rapidly becoming a truly international association, and, as such, it brings together people from many varied backgrounds and cultures for a common purpose. This serves not only the technical and business goals of the UIA, but also the greater goal of understanding that as people we are all equal in our right to pursue our personal lives and our professional interests in an atmosphere of mutual respect and understanding. If we succumb to the temptation to fear or dislike anyone solely because of color of skin, manner of dress or speech, or fundamental beliefs, we descend to the level of those ignorant people who committed or supported the atrocities perpetrated on that now infamous Tuesday in September.

The events of September 11 affected the UIA, as they have most everyone else in the world. Attendance was down somewhat at the Symposium as a result of both travel difficulties and what had by then become a sluggish economy worldwide. But it was important that we continued on with our UIA business, as it is for all of us to continue on with all of our lives; otherwise, in some small way the agents of fear will have won. Like other organizations, the UIA will simply have to adjust to the financial fallout from all of this. In the end, we will be a stronger organization for it.

As your new newsletter editor, I commit this publication to providing timely reports on happenings within the UIA and the ultrasonic industry. As a member of the human race, I re-commit to triumph daily over the temptation to live in fear and prejudice. Let's get on about our business.

Tom Kirkland

PIEZO CERAMIC SHAPES AND ASSEMBLIES



transducers • bimorphs • flats and tubes
monolithic stack actuators • smart sensors and actuators

Total capacity includes engineering and design,
manufacturing, and assembly

Morgan Electro Ceramics

232 Forbes Road • Bedford, Ohio 44146-5418
Tel: (440) 232-8600 • Fax: (440) 232-8731
www.morganelectroceramics.com
sales@morganelectroceramics.com



KERAMOS

Foremost in Piezoelectric
Ceramic Technology

- ◆ NON-DESTRUCTIVE TESTING
- ◆ INDUSTRIAL TESTING
- ◆ MEDICAL DIAGNOSTICS
- ◆ RESEARCH APPLICATIONS
- ◆ PROCESS CONTROL



Keramos is a world-leading manufacturer of high performance Kexite piezoelectric ceramics. Since 1960, Keramos has pioneered many advances in the industry and that tradition of innovation continues today. A superior technical knowledge and experience allows Keramos to serve rapidly advancing industries that require unique piezoelectric ceramic solutions. PZT/Polymer Composites are an example of our innovative, new products.



KERAMOS

ADVANCED PIEZOELECTRICS

5460 West 84th Street, Indianapolis, IN 46268
Tel: (317) 876-4670 • Fax: (317) 876-4661 • Email: sales@keramosinc.com

Visit Our Website: www.kexite.com

President's Message

President's Message - Jeff Vaitekunas

As I begin my term of service as President of the UIA, I first want to thank Mark Schafer and the retiring Board Members for their tireless efforts in improving the UIA for our membership. As a voluntary organization, the UIA is honored to have such dedicated and enthusiastic leadership. I believe it's the enthusiasm for ultrasonic technology that sets us apart from other technologies. I welcome the newly elected Board to their new posts and look forward to working closely with everyone to improve the association and continue the efforts that Mark has begun.

The application of ultrasonics to everything from manufacturing and processing, medicine and surgery, chemistry and physics, and cleaning and welding creates a group of users with common interests despite the diversity of the applications. This is what makes the UIA strong and what attracted me to the association. I love ultrasonic technology and am fascinated by all that it can do. I will try to focus my enthusiasm to better serve the UIA membership.

In order to accomplish our vision of *Being the Forum for Manufacturers, Users, and Researchers in Ultrasonic Technology*, I urge all of our members to participate in areas of the UIA that interest you. Call up a committee chair to discuss how you can be involved. Check the UIA website at www.ultrasonics.org for their phone numbers and to keep abreast of what the UIA is up to. Seek out others excited about ultrasonic technology and inform them about the UIA. Help to improve and expand your association.

We have just completed the annual symposium in Atlanta. Unfortunately, the September 11 terrorist attacks affected travel to the symposium. We had some outstanding presentations and discussions exemplifying the diversity of our organization. For those of you who had to cancel your trip and miss the 2001 symposium, we will try to provide some insight throughout the year to what is happening through this newsletter, and we are planning to have the best-ever symposium in 2002. Mark your calendars today and hold September 18-20, 2002 for the UIA annual meeting. We are finalizing plans and locations and will inform you in the next newsletter.



Dukane quality
doesn't stop with our equipment.

Discover our
Superior customer service
Free applications assistance
On-site equipment demonstrations
After purchase on-site training
Installation assistance
Technical seminars
Custom tooling capabilities
Online shipment tracking
Online purchasing at
www.dukane-store.com

CE and HAFTA compliant
Ultrasonic
Fabric & film
Vibration
Hot plate
Spin

Call 800-884-2300 or
visit www.ultrasonics.com/ua

DUKANE
Intelligent Assembly Solutions

Dukane Corporation • Ultrasonic Division • 2600 Dulles Drive • St. Charles • Illinois • 60174 • USA

Please note:

At the UIA Symposium in October, two papers presented were inadvertently distributed to attendees in draft rather than final form. The final version of each paper was in the UIA's hands prior to the Symposium, but the earlier preliminary versions were printed for distribution in error.

The affected papers were

"The Implications of the Fundamental Formulas for Frequency Selection in Ultrasonic Plastics Welding" by Tom Kirkland

and

"Effects of Frequency on the Cutting Ability of an Ultrasonic Surgical Instrument" by Jeff Vaitekunas.

Please destroy copies of these papers you may have picked up at the symposium and download the corrected versions from the UIA web site, www.ultrasonics.org. If you have passed copies of these papers along to others, please make them aware of this problem and have them destroy their preliminary copies as well.

Thank you for your understanding.

Symposium Summary

The 31st UIA Symposium was held at the Omni Hotel in Atlanta from October 12th through October 14th. It was held in technical collaboration with the IEEE UFFC Conference, which immediately preceded our symposium at the Omni. The goal in the collaboration was to encourage IEEE members, who normally do not attend our symposium, to give the UIA a try. A total of 11 individuals attended both, and 8 of those were IEEE members who were at the UIA Symposium for the first time.

The technical program had scheduled a total of 20 technical papers. But with the attack on September 11, we had some papers cancel. A total of 17 papers were presented, including the two from the P&G and UIA Graduate Research Award recipients, David Grewell and Michael Grossner. Fortunately, two presenters gave presentations for their coworkers, who were not able to attend.

The program started with our keynote speaker, Dr. Bajram Zeqiri, from the National Physical Laboratory in the UK. His talk on the quantification of cavitation was particularly well received. He gave a broad overview of past work in the area and the continuing need for accurate quantification of cavitation. He then discussed his work using a cylindrical transducer to monitor only the center of the transducer and thereby avoid the spatial summation of all of the cavitation events in the region.

A timely presentation was made Michael Taylor of Cepheid on the use ultrasonics to lyze spores. Once the spores are lyzed, the quantity of DNA can be amplified and analyzed with PCR. This technology is to be used in field monitoring for biological agents such as anthrax.



The ever-attentive UIA Symposium participants.

*Send future newsletter
information to:*

**Seth Hettinger, UIA
1111 North Dunlap Avenue
Savoy, IL 61874
phone: (217) 356-3182
fax: (217) 398-4119
e-mail: sethh@assochq.org
web: www.ultrasonics.org**

Measure and Display the Amplitude of Vibration at Ultrasonic Frequencies



PHILTEC, Inc. - Annapolis, MD
 www.philtec.com - tel 410-757-4404 - 800-453-6242 - fax 410-757-8138

"... every one in this industry should have at least one of these!"-Tim Boron of Ultramer Inc.



Dr. Bajram Zeqiri delivers the Keynote Address.

Dr. Gerry Blessing, our dinner speaker, presented an overview of the NIST facility and campus. He highlighted some of the work of the Ultrasound Laboratory to develop precise accurate means to measure and quantify characteristics of ultrasonic transducers and the use of ultrasonics in materials characterization.

Of the 25 who responded to our survey, 23 wanted the annual Symposium to continue, and 20 are planning to attend the 2002 Symposium. But even in light of the September 11 attack, the attendance of 73 was far below the estimated 100 plus attendees. As UIA members, I urge you all to promote



Foster Stulen, left, presents Mark Schafer with a plaque honoring his service to UIA.

INNOVATIVE PIEZO
Transducers

A Full Service Manufacturer Of Quality Ultrasonic Products.

Strict quality control, testing and calibration procedures from design to manufacture, continually assure the highest quality ultrasonic transducers for the petrochemical, pharmaceutical, power generation, pulp/paper, metal, ceramic and polymer processing, and medical diagnostics industries. Etalon is both an OEM supplier and contract manufacturer.

<input type="checkbox"/> Air Transducers & Buzzers	<input type="checkbox"/> High Power
<input type="checkbox"/> Air-In-Line Detector	<input type="checkbox"/> Immersion Search
<input type="checkbox"/> Angle Beam	<input type="checkbox"/> Level Measurement
<input type="checkbox"/> Cables and Adaptors	<input type="checkbox"/> Medical Diagnostic
<input type="checkbox"/> Contact Transducers	<input type="checkbox"/> Oil & Gas Downhole
<input type="checkbox"/> Dual Element	<input type="checkbox"/> Pencil Type Immersion
<input type="checkbox"/> High Temperature to 600°F & 900°F Continuous	<input type="checkbox"/> Thickness Gauging
	<input type="checkbox"/> Wedges

Etalon
 Innovative Piezo Transducers
 1800 W. Main St., P.O. Box 127, Lebanon, IN 46052 • U.S.A.
 Tel: (765) 483-2550 • Fax: (765) 483-2550 • Email: etalon@in-motion.net

Visit Our Website: www.etaloninc.com

Stapla gets the call...

Whenever There's a Need to Ultrasonically Weld Metals and Plastics

Whether you need a delicate touch to weld metal foils and small plastic parts in the manufacture of cell phones/batteries or the power to splice heavy-duty electric cables in manufacturing wiring harnesses, Stapla has the quality solution. Stapla ultrasonic welding is faster, cleaner, and stronger than other attachment methods. Stapla systems have advanced user-friendly features including self-calibration, self-diagnostics and active quality controls. This means that they can provide the continuous QC monitoring you need in any manufacturing operation to maintain high yields.



To learn how Stapla ultrasonic metal and plastic welding systems can improve your assembly process, send us a joining application sample and we'll provide a free evaluation, or call toll-free, 888-679-6900.

STAPLA
Ultrasonics
Corporation

A  Company

875 Industrial Street • Needham, MA 01949
Tel.: 888-679-6900 • www.stapla.com

*Would you like to gain recognition in
the Ultrasonics Industry?
Find out how to appear in Vibrations.*

**Contact Seth Hettinger, UIA
phone: (217) 356-3182
e-mail: sethh@asochq.org**

Symposium Summary . . . cont.

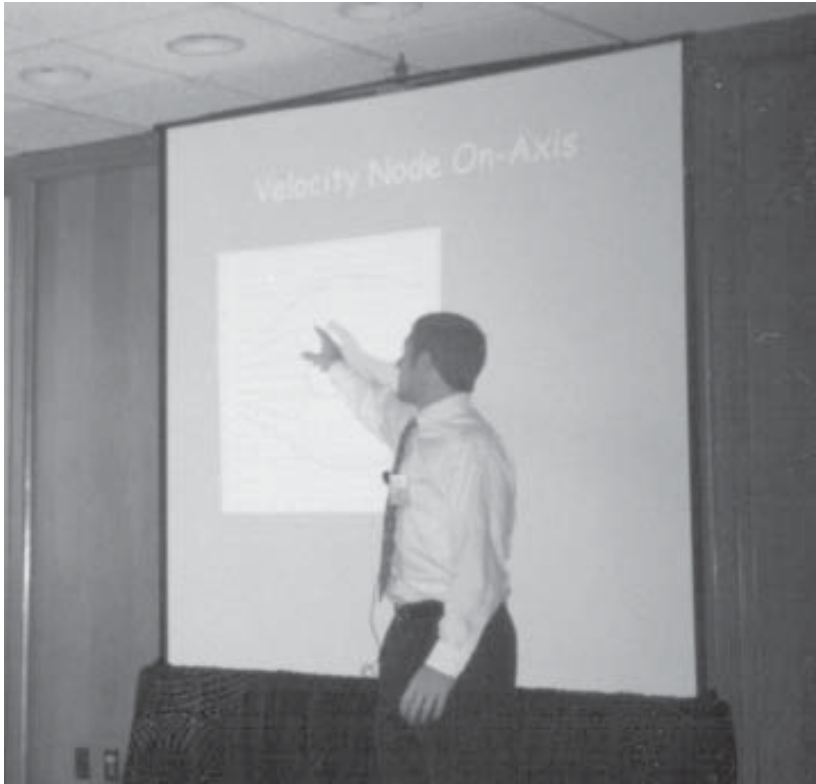

Michael Grossner, UIA award winner, discusses ultrasonically activated filtration.

the UIA with your coworkers and colleagues, to encourage them to both join the UIA, and to attend next year's symposium. Also, please request that your company or your vendors in ultrasound products and services support the UIA by advertising in the *Vibrations* newsletter and by exhibiting at the symposium. The UIA Board welcomes your suggestions and recommendations for growing the UIA and making the symposium relevant and exciting.

Foster B. Stulen, Ph.D., P.E.
Co-Chair 31st UIA Symposium

UIA Board of Directors

If you are interested in participating on the Board of Directors or a UIA Committee, please contact Jeff Frantz at jfrantz@bransonultrasonics.com

Jeff Vaitekunas, President

Ethicon Endo-Surgery, Inc.
Phone: (513) 337-3488
jvaiteku@eesus.jnj.com

Tom Kirkland, Vice President

Dukane Corporation
Phone: (630) 584-2300
tkirkland@dukane.com

Janet Devine, Secretary

Sonobond Ultrasonics
Phone: (800) 323-1269
jdevine@sonobondultrasonic.com

Mark Schafer, Treasurer

Perceptron, Ultrasound Technology Group
Phone: (267) 872-5602
marks@sonictech.com

S. Berliner, III

Consulting in Ultrasonic Processing
Phone: (516) 759-7360
berliner-ultrasonics@att.net

Alan Broadwin

Ainslie
Phone: (914) 833-2649
broadwin@ainslie.com

Paul Fenton

Axya Medical
Phone: (978) 232-9997
pfenton@axya.com

Jeff Frantz

Branson Ultrasonics
Phone: (203) 796-2223
JFrantz@bransonultrasonics.com

Ronald Manna

Misonix, Inc.
Phone: (631) 694-9555
rmanna@misonix.com

G. Adam Morris

Piezotech
Phone: (317) 876-4670
etalon@in-motion.net

Ron Staut

APC International, Ltd.
Phone: (570) 726-6961
ronstaut@aol.com

Foster Stulen

Ethicon Endo-Surgery
Phone: (513) 337-3112
FStulen@EESUS.JNJ.com

Alan Winder

Acoustic Science Associates
Phone: (203) 225-0810
aawinder@aol.com

Ultrasonic Industry Association

1111 North Dunlap Avenue, Savoy, IL 61874
Phone: (217) 356-3182; Fax: (217) 398-4119
E-mail: uia@ultrasonics.org; Web: www.ultrasonics.org

**Ultrasonic Industry Association
1111 North Dunlap Avenue
Savoy, IL 61874**

**Non-Profit Organization
U.S. Postage
PAID
Permit No. 113
Champaign, IL 61820**