

RECENT ADVANCES IN THE DEVELOPMENT AND APPLICATION OF POWER PLATE TRANSDUCERS IN GAS DENSE EXTRACTION AND AEROSOL AGGLOMERATION PROCESSES

Enrique Riera^{a}, Andrea Cardoni^b, Juan A. Gallego-Juárez^{a,b}, Víctor M. Acosta^a, Alfonso Blanco^a, Germán Rodríguez^{a,b}, Antonio Mulet^c, Miguel Blasco^d, Luís E. Herranz^e*

^aGrupo de Sistemas y Tecnologías Ultrasónicas, Dpto. de Sensores y Sistemas Ultrasónicos, ITEFI, CSIC, Serrano 144, E28006-Madrid, Spain

^bPUSONICS S.L., Pico Mulhacen, 34, E28500-Arganda del Rey, Madrid, Spain

Grupo de Análisis y Simulación de Procesos Agroalimentarios, Food Technology Department, Universitat Politècnica de Valencia, Valencia, Spain

^dCentro Tecnológico Ainia, Benjamín Franklin 5-11, E46980-Paterna, Valencia, Spain

^eUnidad de Seguridad Nuclear, División de Fisión Nuclear, CIEMAT, Avda. Complutense, 22, E28040-Madrid, Spain

Outline

- Power plate transducers. Recent Advances
Characterization under power operation
- Application in Food Processing
Ultrasound-assisted Gas Dense Extraction
- Application in Environmental Pollution
Acoustic Agglomeration of Aerosols
- Results and Conclusions



Power Plate Transducers. Recent Advances Non Linear Characterization under Power Operation

POWER PLATE TRANSDUCERS

Power plate transducers. Recent Advances

- Large vibrating surfaces (circular, rectangular, square, cylindrical...)
- Improvement of the radiator design to reach (as much as possible) uniform acoustic field distribution
- Acoustic fields coherent or focused
- Nonlinear characterization under power operation

Main Problems

- Fatigue crack
- Modal Interaction
- Nonlinear Dynamic Response

POWER PLATE TRANSDUCERS. RECENT ADVANCES

Response Characterization - Experimental Set-up (1)

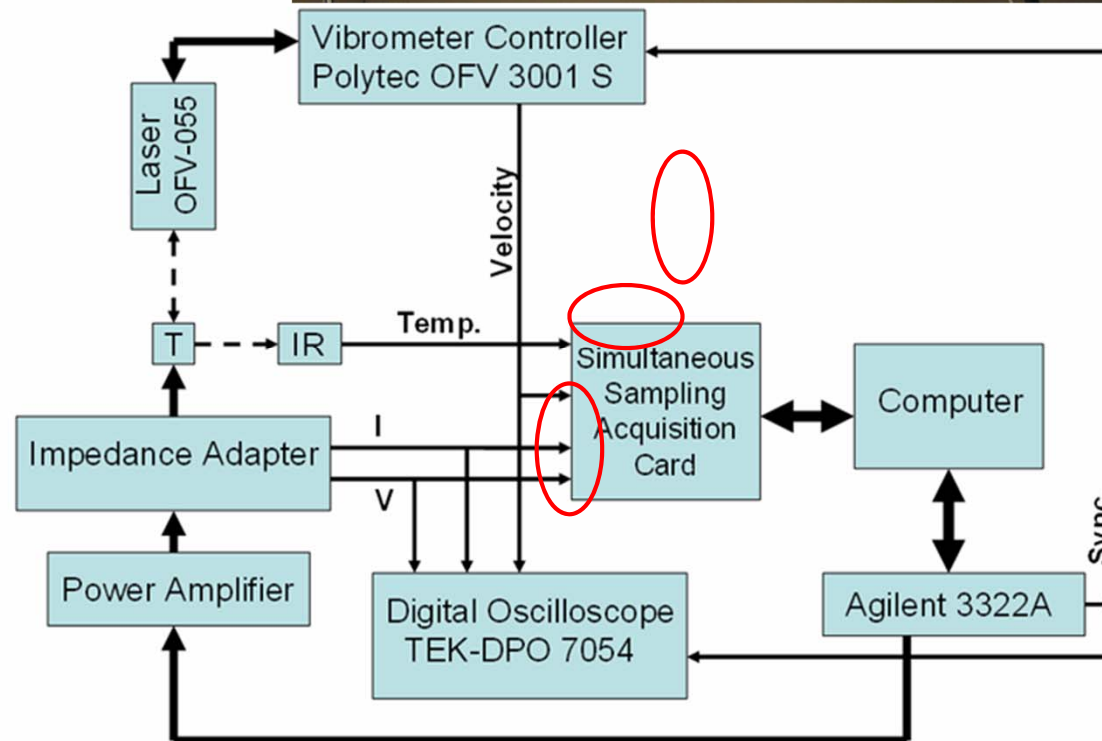

Riera, E, et al., (2007) Proceedings of the International Congress on Ultrasonics, Vienna, April 9-13, Paper ID 1435 (<http://proceedings.icultrasonics.org/>)

Cardoni, A., et al., (2009) IEEE International Ultrasonics Symposium, Rome, September 2009. DOI:10.1109/ULTSYM.2009.5441864

Riera, E., et al., (2010) Proceedings 39th International Congress on Noise Control Engineering, Inter noise 2010, 13-16 June Lisbon, Portugal.

Cardoni, A., et al., (2012) Proceedings of the Institution of Mechanical Engineers, Part C: Journal of Mechanical Engineering Science, Vol. 226, pp. 2044-2052.

Cardoni, A., et al., (2013) International Congress of Ultrasonics, Singapore, May, 2013, pp. 173-178, ISBN: 978-981-07-5938-4_P0215

POWER PLATE TRANSDUCERS. RECENT ADVANCES

Response Characterization - Experimental Set-up (2)

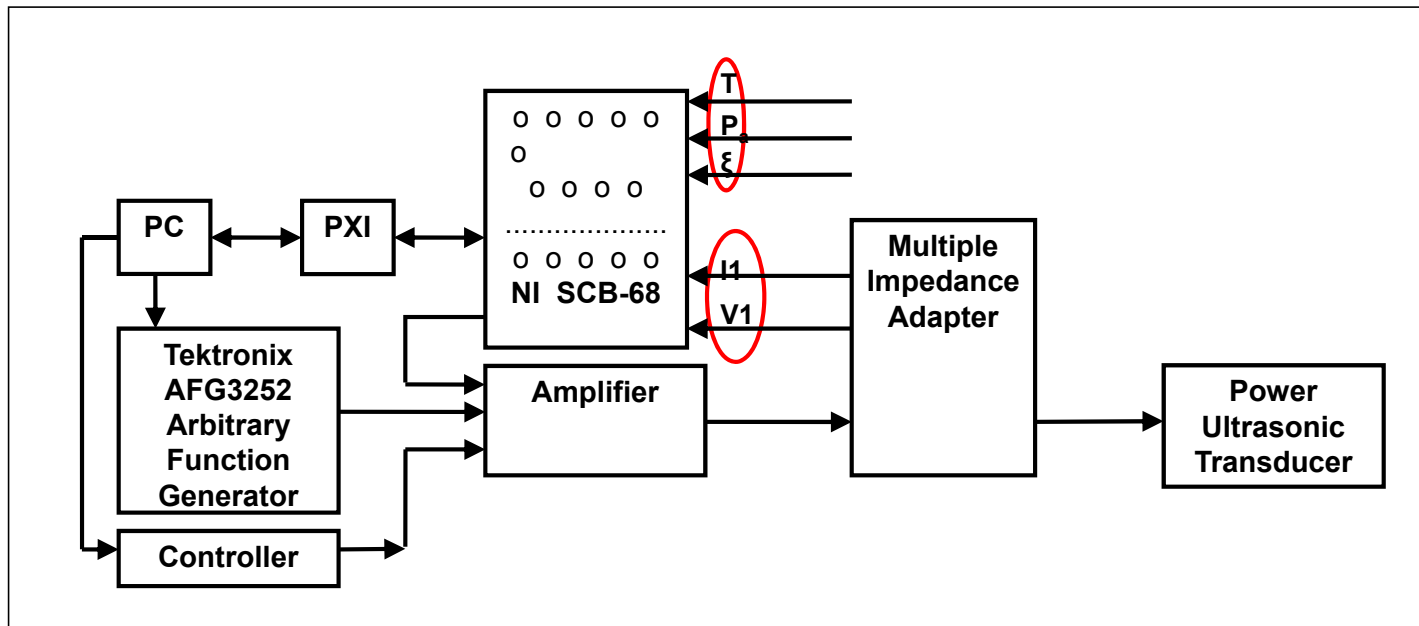
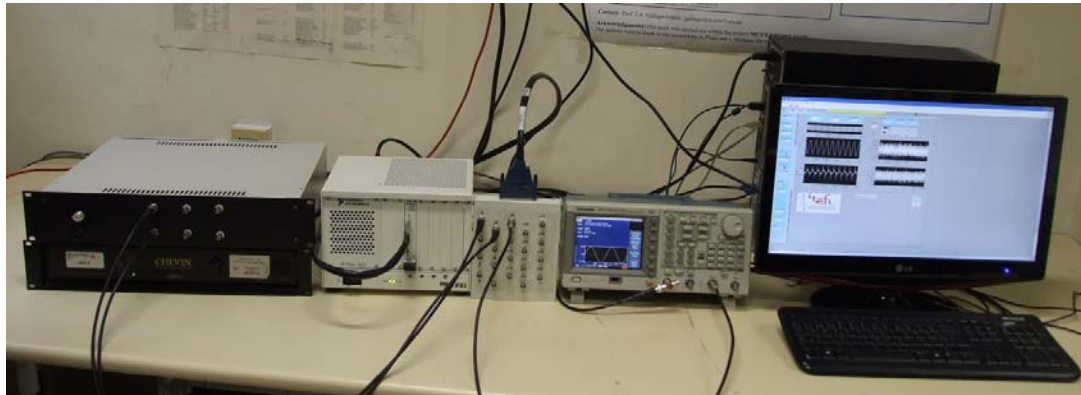



Application in Food Processing

Ultrasound-assisted Gas Dense Extraction

Ultrasound-assisted Gas Dense Extraction

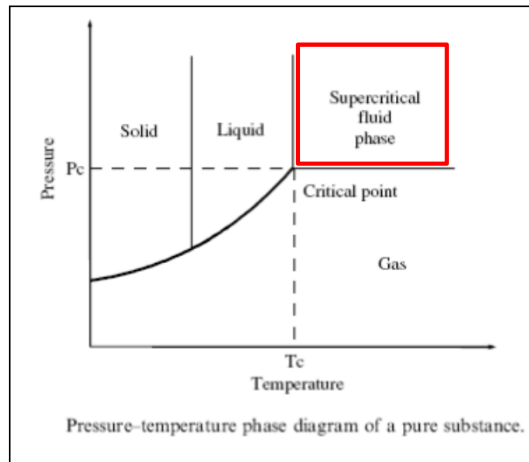

T_c = Temperature above which it cannot be liquefied by increase of Pressure

P_c = Critical Pressure

$(CO_2)^{sc}$ $T_c = 304,2\text{ K} = 31,2\text{ °C}$

$P_c = 72,8\text{ atm}$

DG: Have lower viscosity and higher diffusivity than liquid solvents. Can penetrate into porous materials more effectively than liquid solvents

PU enhances mass transfer processes due to the physical effects produced on the surface of particles by:

Compressions and decompressions, radiation pressure, streaming, agitation, turbulence, cell structure damage, intra-particle diffusivity.

The absence of phase boundaries in the supercritical region excludes the presence of cavitation.

- **DGE** is a separation process based on the contact of a substance containing the extractable compound with a solvent (CO_2) under supercritical conditions.
- **Motivations to use DGE:** Non-Toxic; Recyclable; Cheap; Relatively Inert, Non-Flammable; Improves Product Quality and Recovery
- **Disadvantages: Slow Kinetics**
- **Proposal:** US-assisted DGE to enhance mass transfer in almonds oil extraction because the use of mechanical stirrers is unable
- **Advantage: Ultrasonic energy acts without affecting the main characteristics and quality of the products**
- **Potential Applications:**
Food, Pharmaceutical, Cosmetic and Chemical Industries

MAIN OBJECTIVE

Design and construct a Robust and Autonomous PU-System to evaluate the influence of US on the GDE-Kinetics and final quality of almond oil and as a new ultrasonic technology

Pilot Plant - Extractors 5 Liters

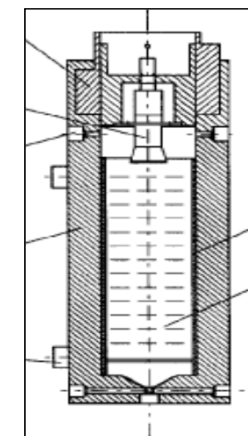
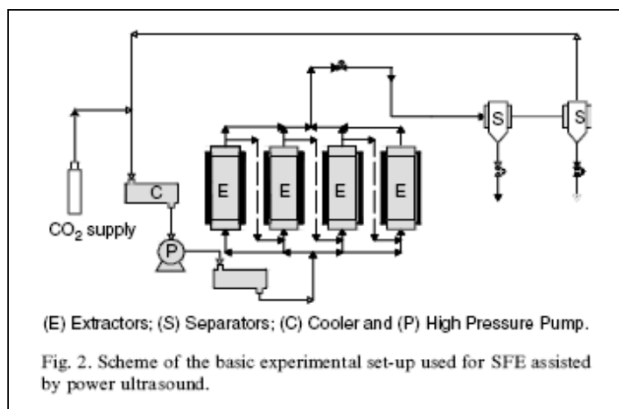

Transducer placed WITHIN the extractor
 $P_{max} = 125W$
 $f = 20 \text{ kHz}$

Almond oil extraction using supercritical CO_2 (GDE)

$f=20kHz$, $P_r=280bar$, $T=55^\circ C$, $F=20kg/h$,
 $P=50W$
 Extraction rate enhanced by 30%
 Yield extracted increased up to 28%
 Grounded almond: 3-4 mm to 9-10mm

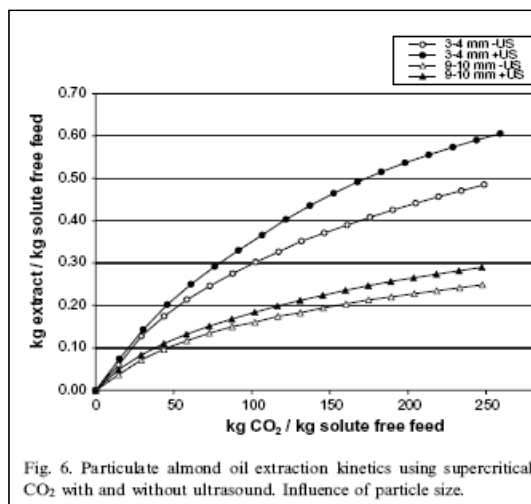

E. Riera et al. Ultrasonics Sonochemistry 11 (2004) 241-244.
E. Riera et al., European Patent EP 1 547 679 A1 (2005)
E. Riera, et al., Ultrasonics 50 (2010) 306-309

Pilot Plant - Extractors 5 Liters Transducer Design by FEM

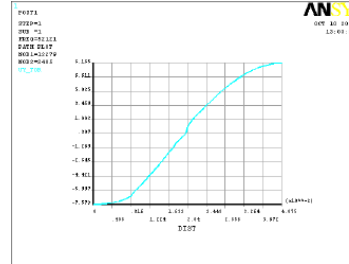
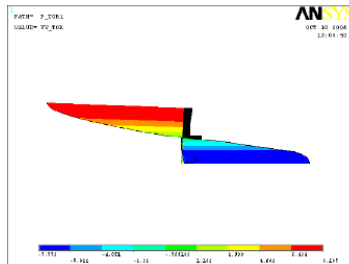
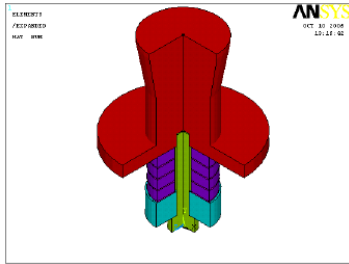

Langevin Transducers for 5L Extractors

$f = 18-50 \text{ kHz}$
 $P = 20W - 125W$



$F = 46 \text{ kHz}$
 $P = 50W$



$F = 20 \text{ kHz}$
 $P = 125W$

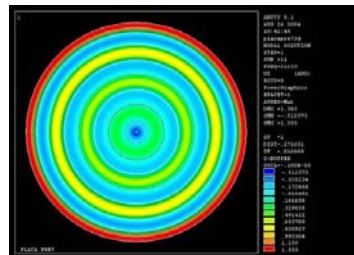
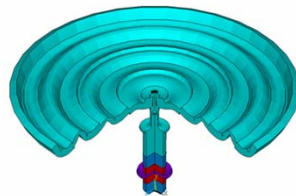
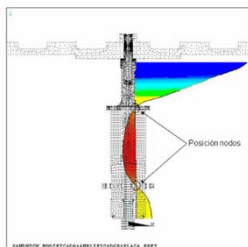

Stepped Plate Transducer for 20L Extractors

$f = 21- 50 \text{ kHz}$
 $P = 75W-300W$

Transducer Validation by Laser Vibrometer (18-22 kHz)

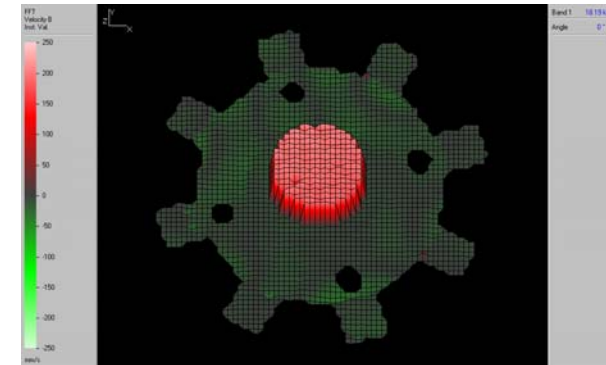
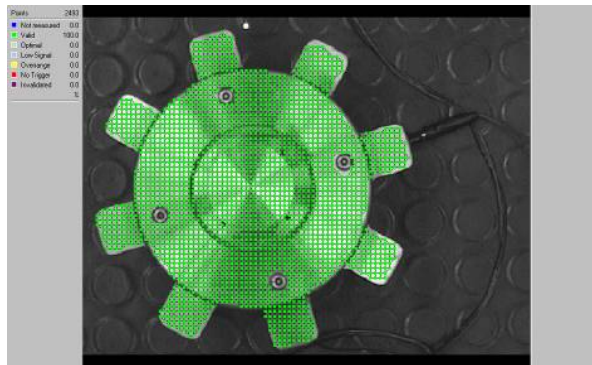
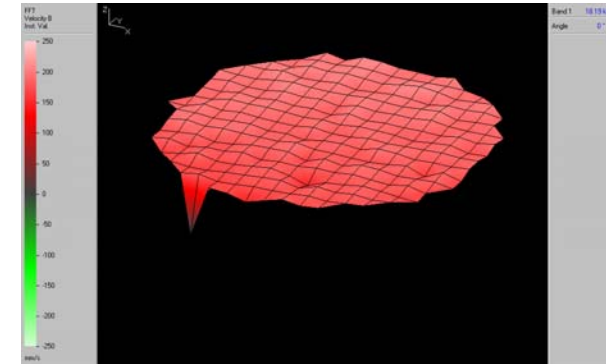
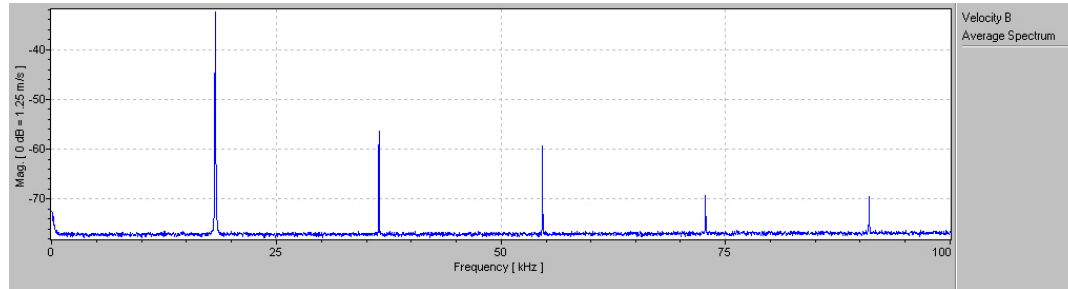

Transducer Validation by Laser Vibrometer (40-50 kHz)

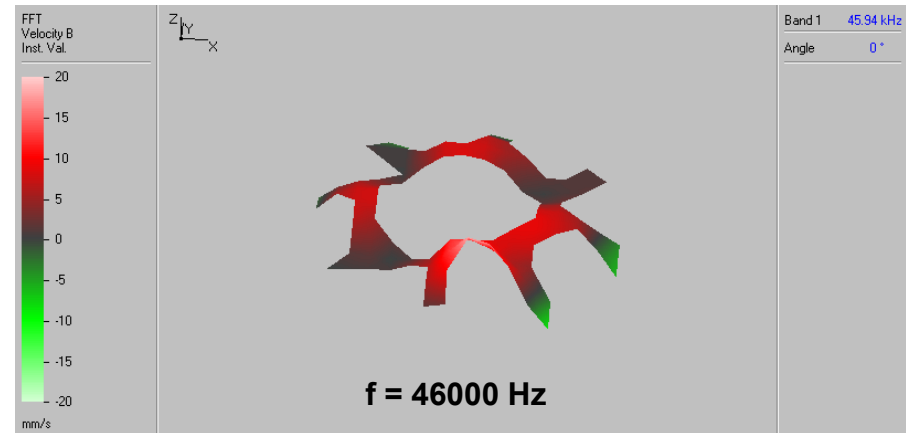
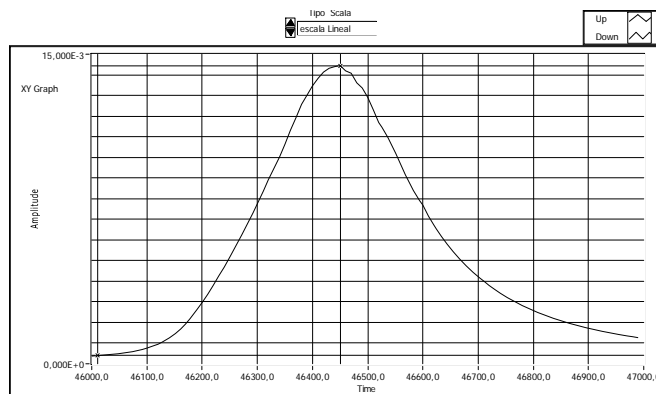
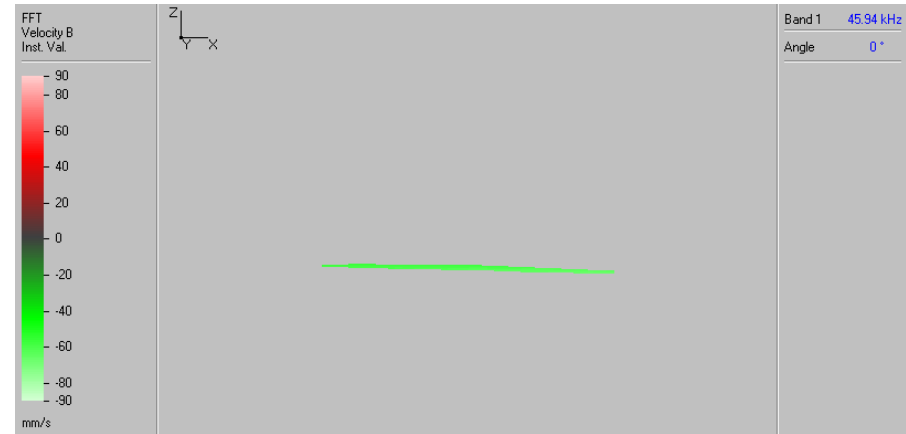
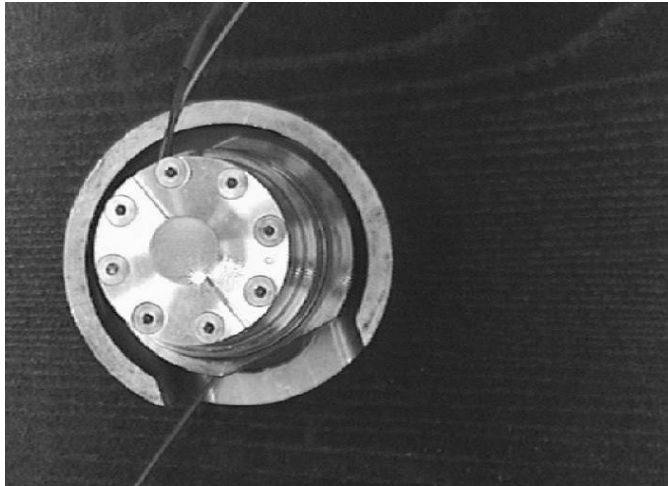

Ultrasound-assisted Gas Dense Extraction Control and Monitoring Tools (LabView)

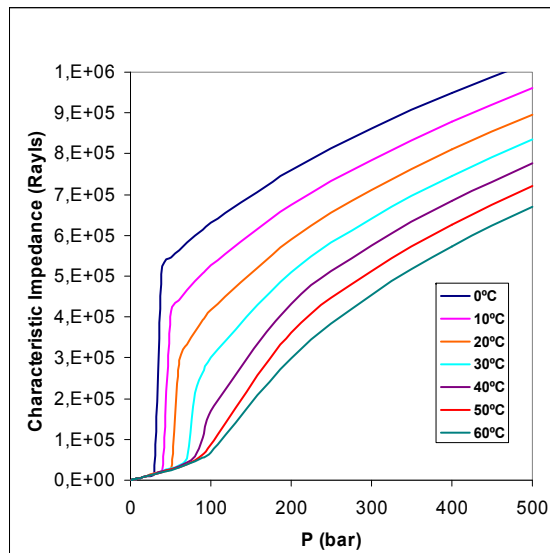
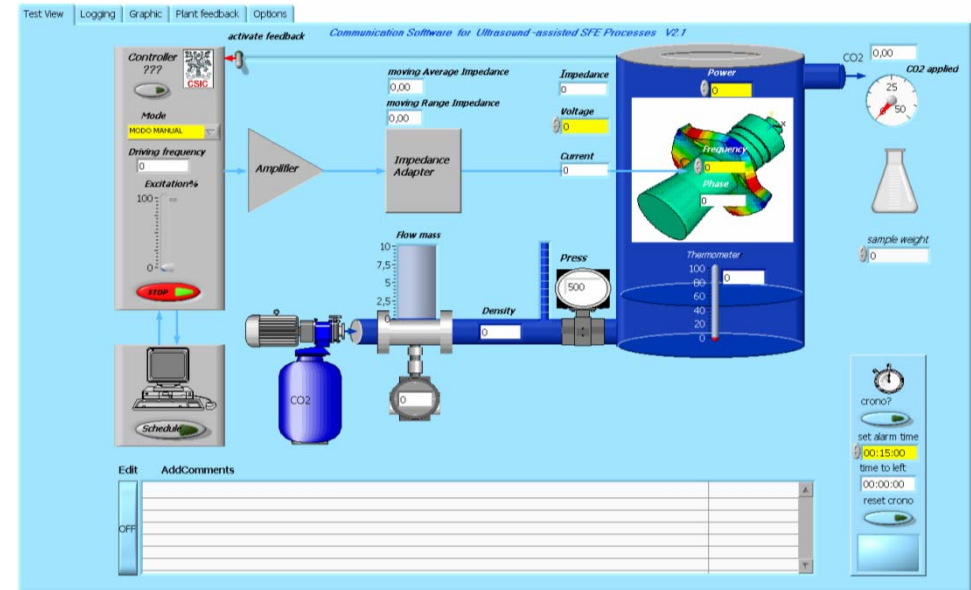
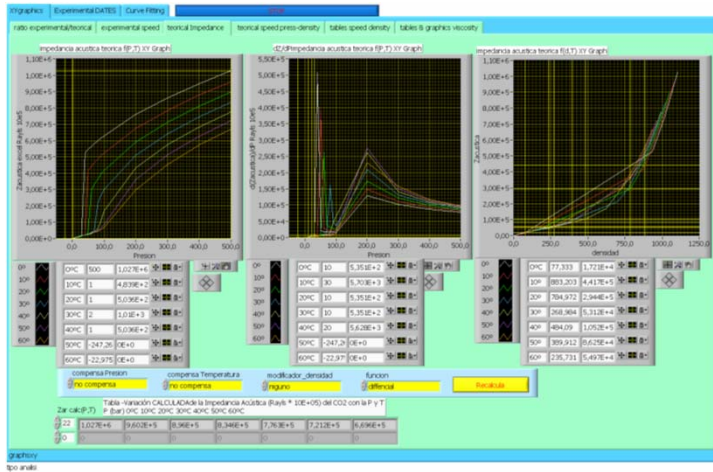

CHARACTERISTIC IMPEDANCE IN THE EXTRACTOR UNIT

20°C	1bar	$Z=5 \times 10^2$ Rayls
55°C	280bar	$Z=5 \times 10^5$ Rayls

Pilot Plant – Extractor (5L) with Ultrasound



FSC 20 Front View

Extractor Volume = 5 L

Number of Extractors = 4

$P_r \leq 350$ bar

$T \leq 80^\circ\text{C}$

Mass Flow (CO_2^{sc}) ≤ 40 kg/h



Front View

1. PFS20 equipment for SC processes (own design)
2. Power ultrasonic generator
3. Control and monitoring PC

Pilot Plant – Extractor (5L) with Ultrasound

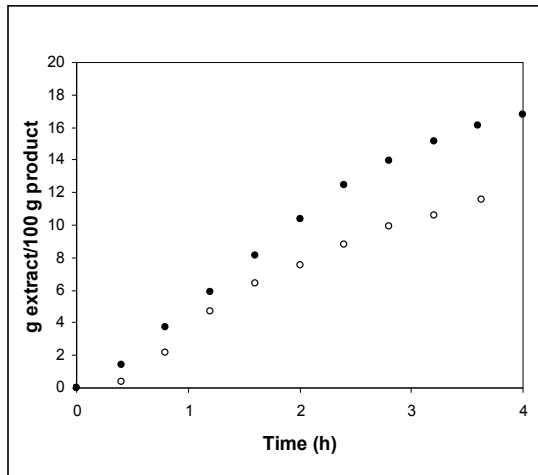

P = 320 bar, T = 65°C, F = 12.5 kg/h, 20 kHz, 75W
Grounded almond-oil extraction – US and +US.

Product in the basket

Amount = 1500 g

Almond = Grounded Marcona

Particle size = 3 – 4 mm

Initial oil content = 56 %

Improvement ~ 90%

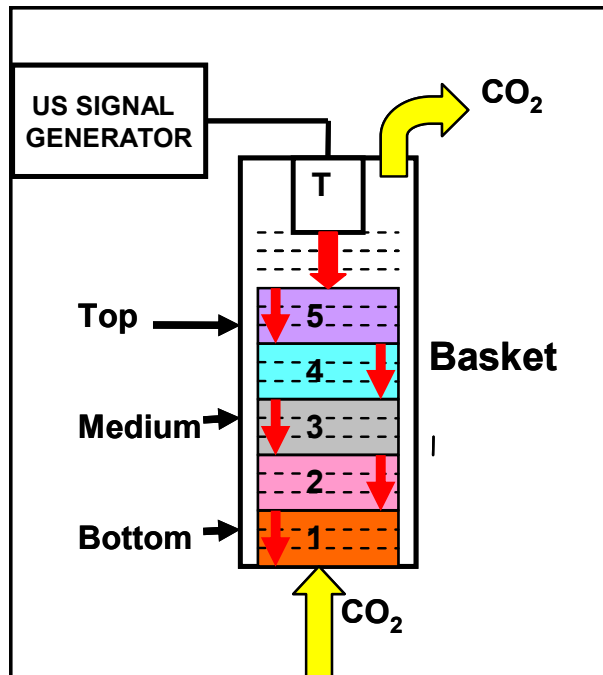

Mass Transfer Zone (MTZ)

EXPERIMENTAL SET-UP AND METHODOLOGY

A series of almond-oil extraction trials were performed in the 5L Extractor:

Basket = 1500 g (grounded almond)

T = 45 °C; P = 33 MPa; Flow rate = 15 kg/h

HPU transducer:

f = 20 kHz; 75W

For each trial samples at different heights inside the basket were taken.

Basket divided in 5 layers: **Layer 1** → Bottom **Layer 3** → Medium **Layer 5** → Top

E. Riera, et al., (2007) Proceedings 19th International Congress on Acoustics, ICA2007 Madrid, ISBN: 84-87985-12-2

M. Blasco, et al., (2010) Proceedings 20th International Congress on Acoustics 2010, ICA2010 Sydney, 23-27 Agosto. Australia

Pilot Plants – Extractors 5L-20L with Ultrasound



Pilot Plant PFS20
5 L Extractor Unit
1 Basket/Extractor

HPU System to assist
DGE processes in 5 L
extractor vessel

New Pilot Plant
20 L Extractor Unit
2 Baskets/Extractor

Pilot Plants – Extractor 20L with Ultrasound



First prototype plate Transducer for DGE

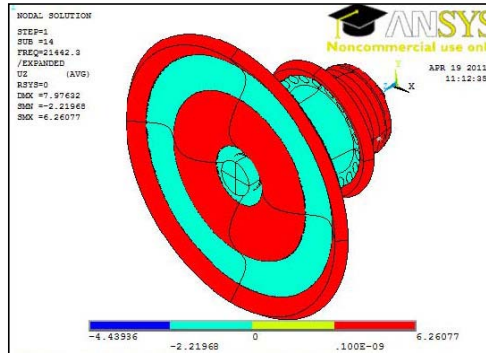

Top view of the extractor with 1,5 kg of grounded almond in the basket

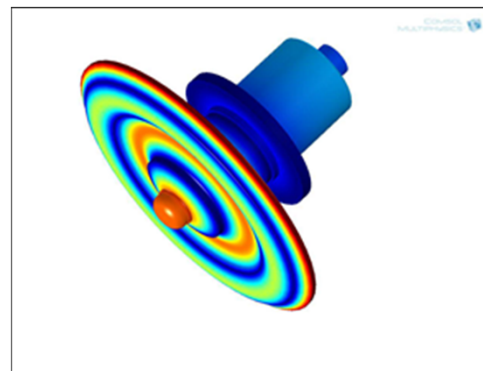

Last prototype of the Plate Transducer for DGE

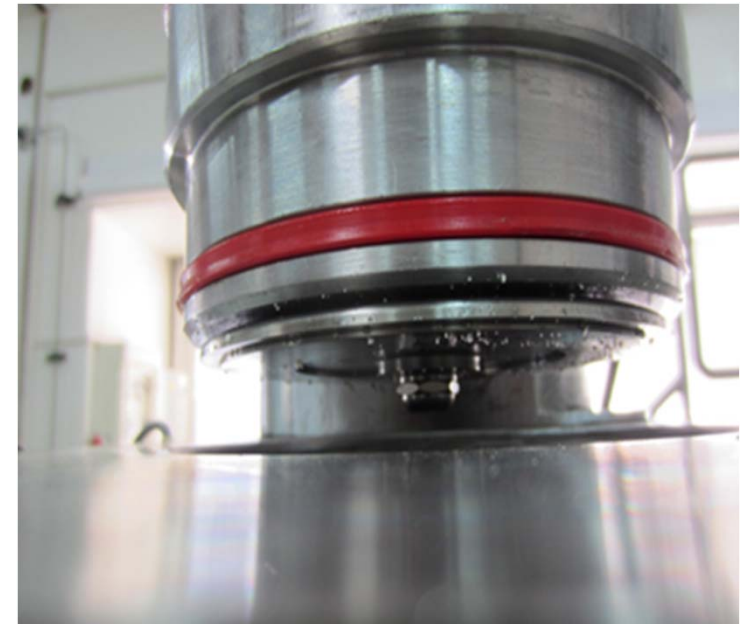

Lateral view of the plate transducer placed on the upper lid of the vessel

Pilot Plants – Extractor 20L with Ultrasound

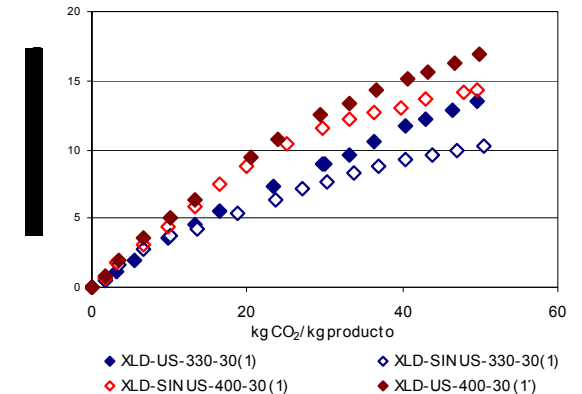
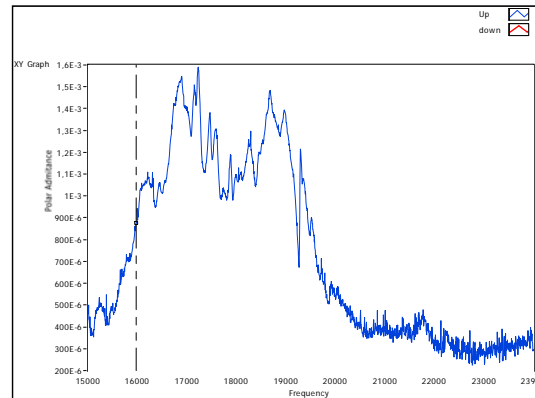
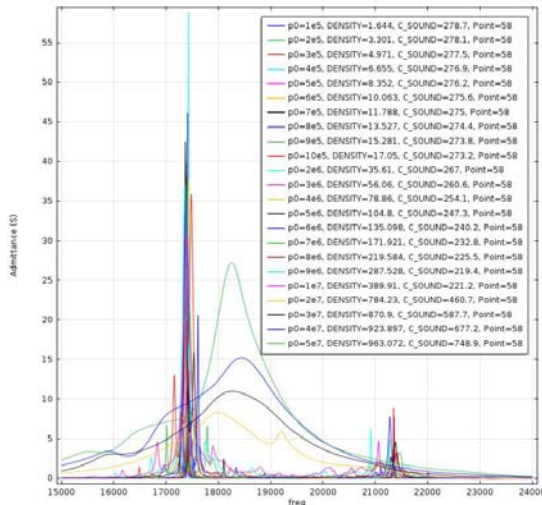
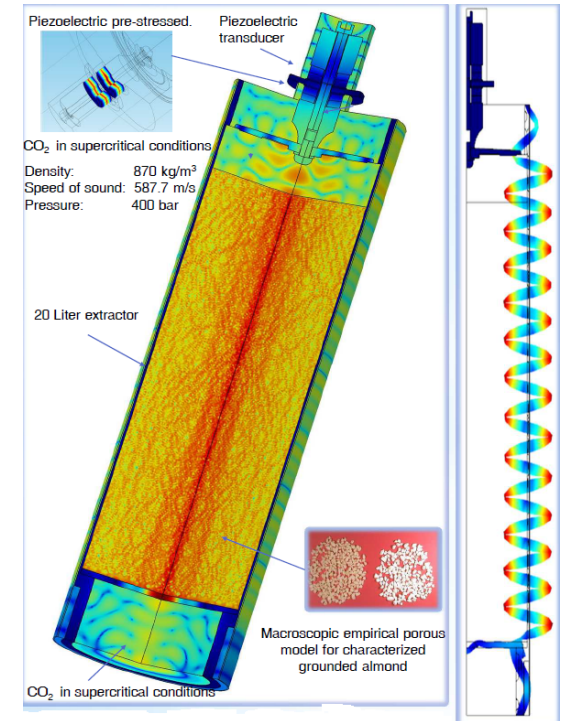
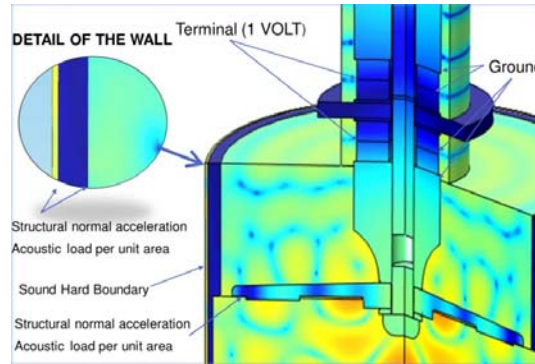
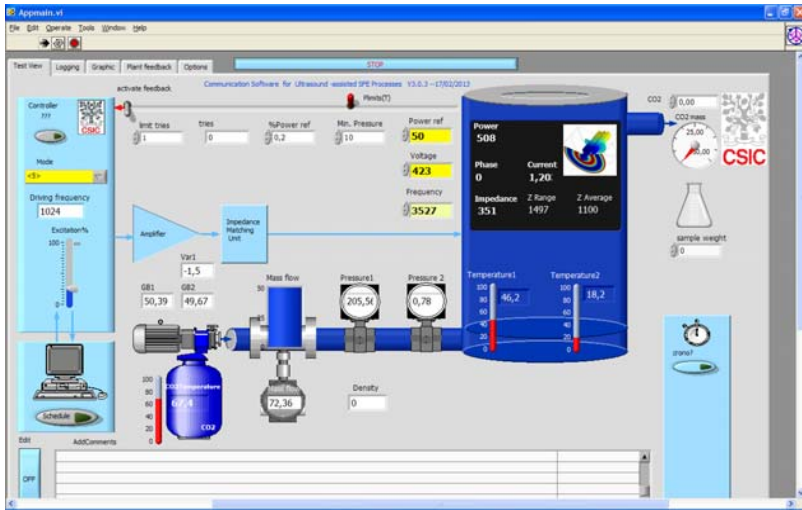

Extraction kinetic curves at 330-400 bar, 45°C
 Raw matter = 1,5 kg
 Mass flow = 35 kg/h

Experimental Results with Ultrasound

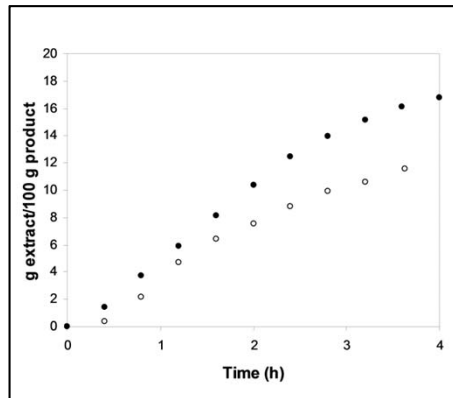

Almond-oil extraction curve from grounded almond at
320 bar, 45°C, 10kg/h
Extraction time = 3.5 h
Particle size: 3-4 mm
Improvement = 40%

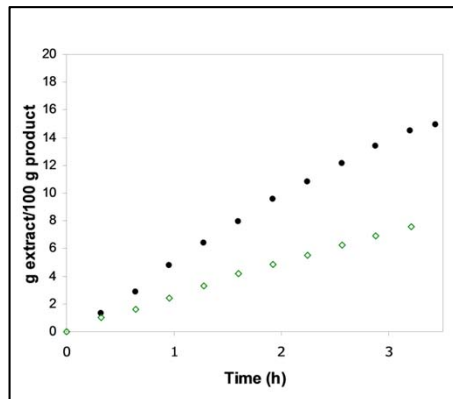

Almond-oil extraction curve from grounded almond at
280 bar, 45°C, 10kg/h
Extraction time = 3.5 h
Particle size: 3-4 mm
Improvement = 90%

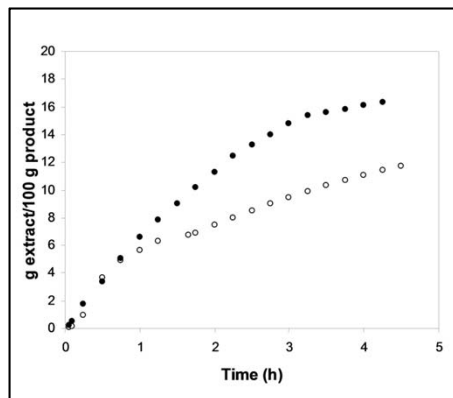

Cocoa cake-oil extraction curve from grounded almond at
320 bar, 65°C, 10kg/h
Extraction time = 4 h
Particle size: 3-4 mm
Improvement = 43%

Pilot Plants – Extractors 5L -20L with Ultrasound



Pilot Plant – Extractor 20L with Ultrasound

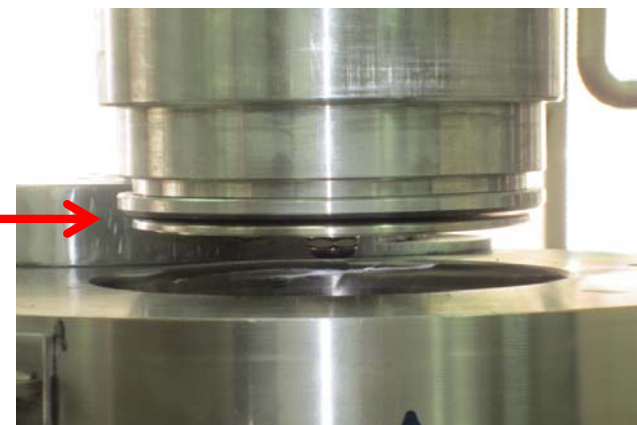
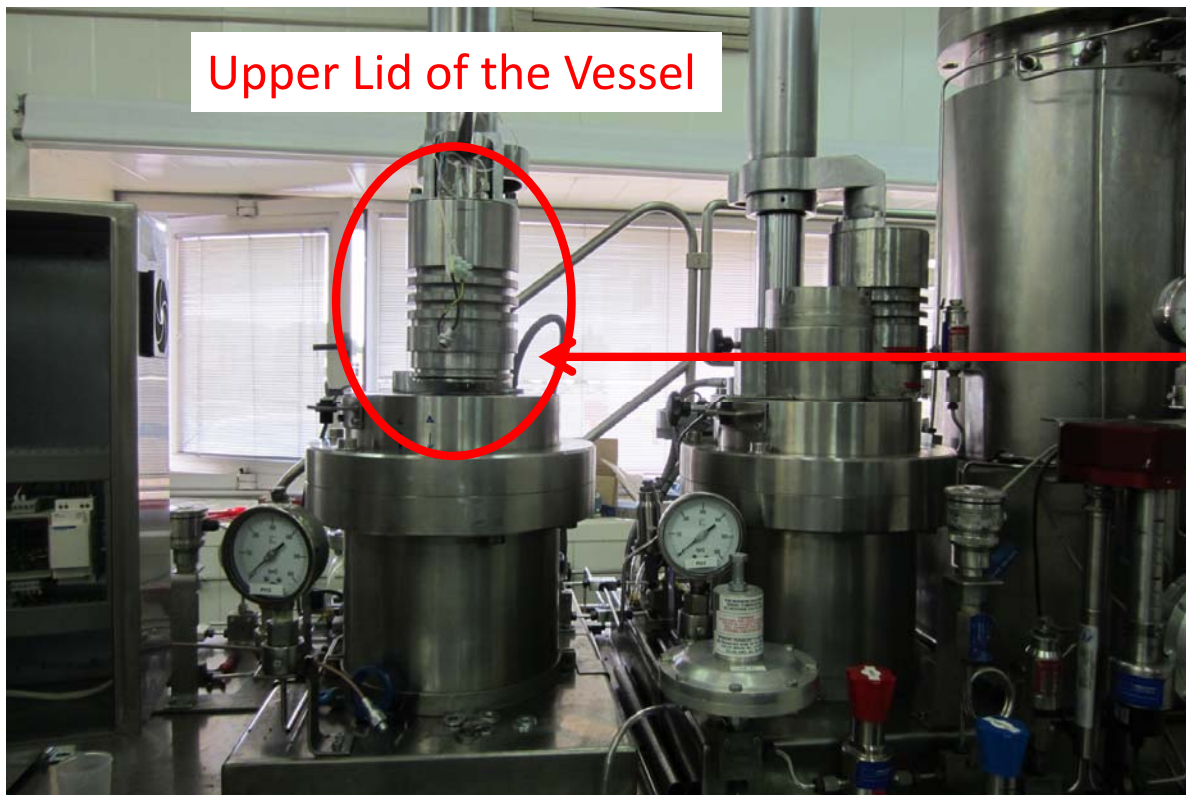
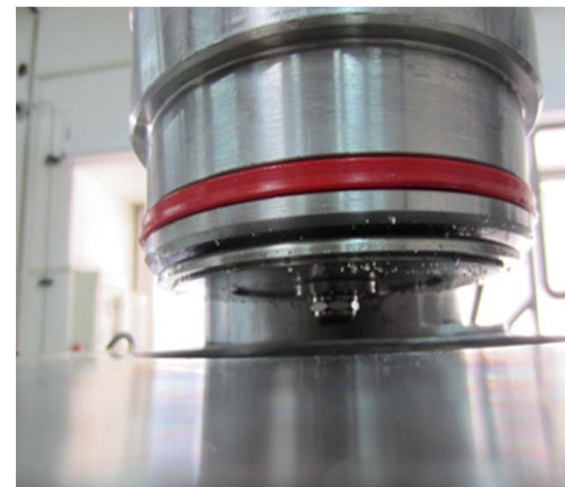
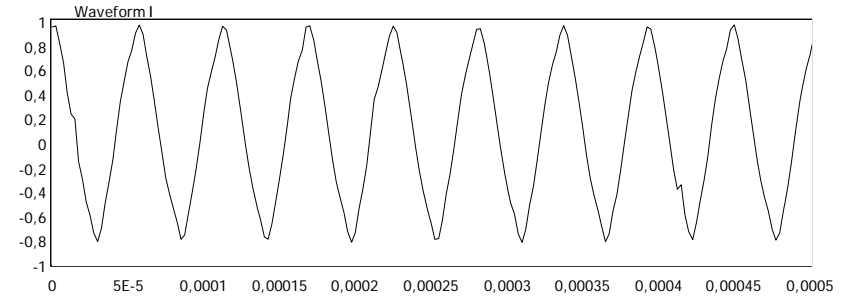

Plate Transducer Assembling



Pilot Plant – Extractor 20L with Ultrasound



Electric current in the transducer at
400 bar, 45°C, 250W

Front and lateral views of the
Driving Ultrasonic System

- Controller + Impedance Adapter
- Power Amplifier

Control and Monitoring System

- Computer and Acquisition card

Parameters: transducer (f, V, I, ϕ , P, Z)

extractor (Pr, Temp, Mass Flow)





Application in Environmental Pollution

Acoustic Agglomeration of Aerosols

Acoustic Agglomeration of Aerosol Particles

Air Cleaning: Fine particle removal from industrial fumes (Environment)

ACOUSTIC EFFECTS THAT DETERMINE THE AGGLOMERATION PROCESS

- **Orthokinetic particle interaction (linear)**
The motion of particles in a viscous flow field is determined by their inertia. Larger particles are more stationary, while smaller and lighter ones tend to move with the fluid motion. The resulting relative motion between particles can lead to particle collisions and agglomeration
- **Acoustic entrainment by the scattered wave (linear)**
Entrainment into the scattered wave induced by the presence of a nearby obstacle (mutual scattering interaction)
- **Second order effects**
 - Mutual radiation pressures effect (MRPE)** by scattered waves (non-linear)
 - Acoustic wake effect (AWE)**. Due to asymmetric viscous flow fields (non-linear)
 - Acoustic streaming**. Absorption of the acoustic wave within the suspension leads to the decay of the momentum associated with the wave propagation. It provokes different effects such as entrainment, mixing, dispersion and collision of the particles

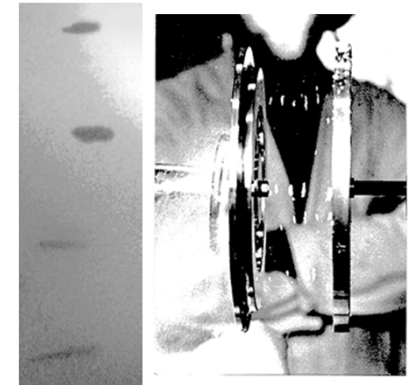
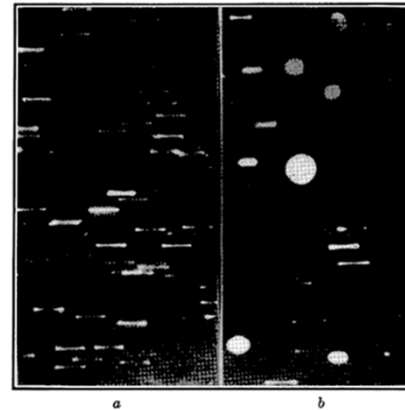

OE



AWE

Gallego-Juárez, J.A., et al., (1994) USA Patent No. 5299175.

Gallego-Juárez, J.A., et al., (1996) 'High Temperature Gas Cleaning, Karlsruhe, Inst. Mech. Verfahrenstechnik und Mechanik, 60-68.

Acoustic Agglomeration of Aerosol Particles

Air Cleaning: Fine particle removal from industrial fumes (Environment)

SCHEME AND PHOTOGRAPH OF MULTIFREQUENCY (10 – 21 kHz) AGGLOMERATION CHAMBER - POWER PLANTS (COAL COMBUSTER)

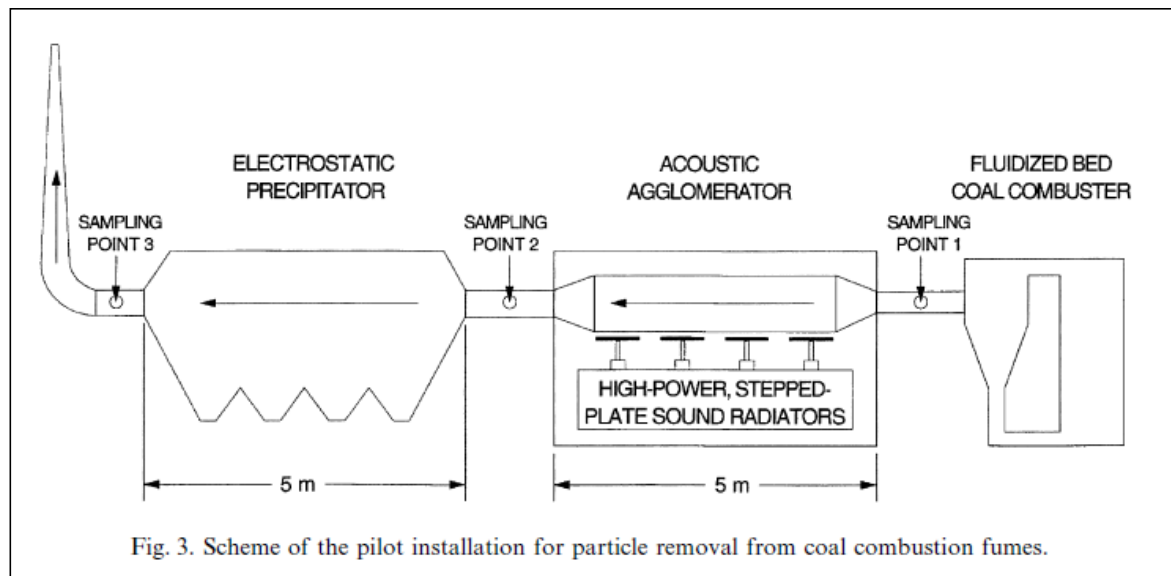

Acoustic Agglomeration of Aerosol Particles

Air Cleaning: Fine particle removal from industrial fumes (Environment)

ACOUSTIC FIELD INSIDE THE MULTIFREQUENCY (10 – 21 kHz) AGGLOMERATION CHAMBER

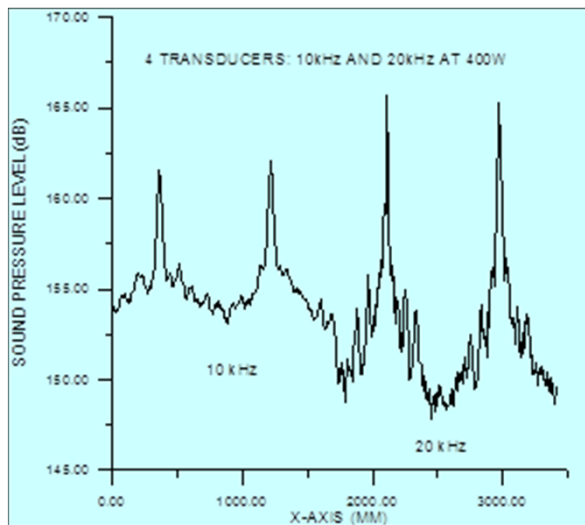

Mean SPL profile of the macrosonic field along the axis of the agglomeration chamber (CW excitation)

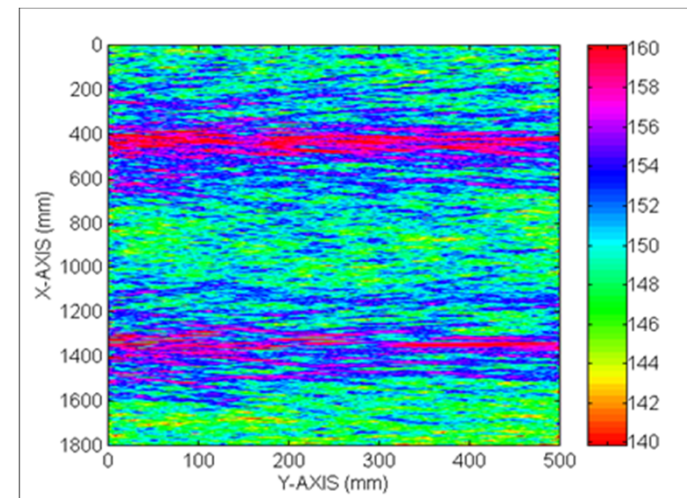

2D visualization of the acoustic field measured within one of the two modules of the UAC and generated by two 21 kHz-transducers at maximum power level (2T x 350 W).

Gallego-Juárez, et al., (1999) Environ Sci. Tech., 33, 3843-3849.

Gallego-Juárez, et al., (2000) Ultrasonics, 38, 331-336.

Riera, E., et al., (2000) Ultrasonics, 38 (1-8), 642-646.

Riera, E., et al., (2000) J Aerosol Sci, 31 Suppl.1, S827-S828.

González, I., et al., (2001) Acta Acustica united with Acustica, 87, 544-460.

González, I., et al., (2001) Acta Acustica united with Acustica, 87, 454-450

Acoustic Agglomeration of Aerosol Particles

Air Cleaning: Fine particle removal from industrial fumes (Environment)

REDUCTION OF PARTICLE EMISSIONS

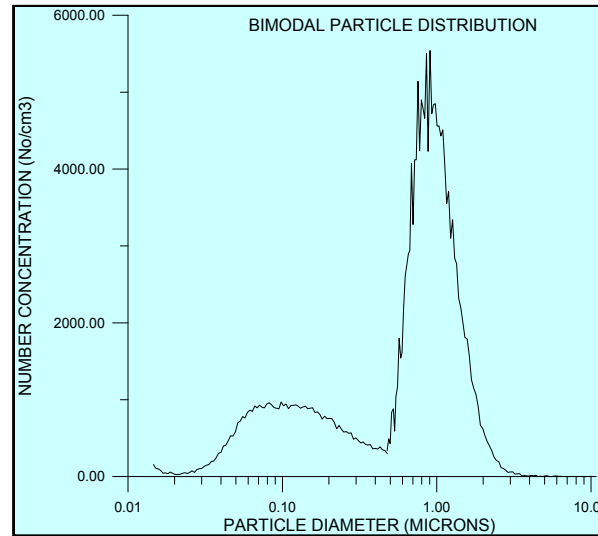

Submicron particles
 $\eta = 70\% \rightarrow 87\%$

Micron particles
 $\eta = 90\% \rightarrow 97\%$

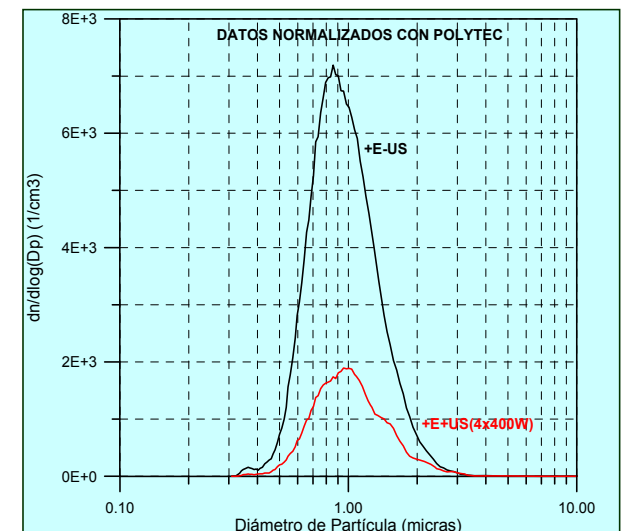
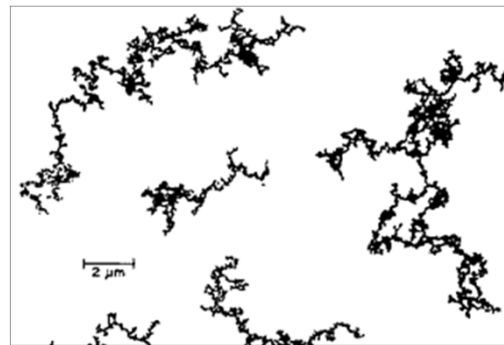
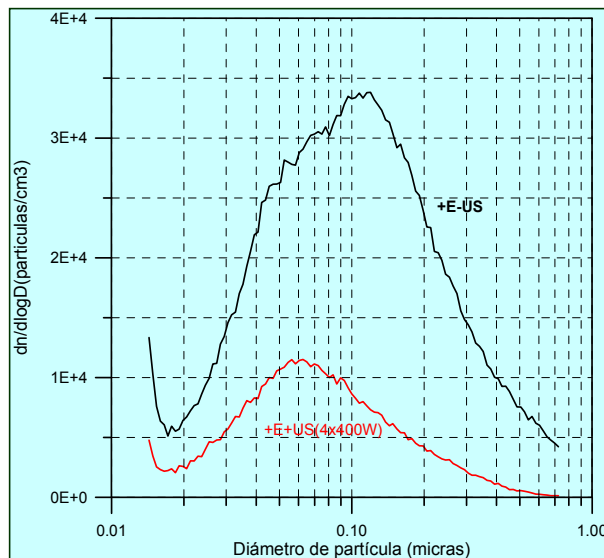

Acoustic Agglomeration of Aerosol Particles

Air Cleaning: Fine particle removal from industrial fumes (Environment)

REDUCTION OF PARTICLE EMISSIONS

EFFECT OF HUMIDITY IN THE ULTRASONIC AGGLOMERATION PROCESS OF DIESEL EXHAUSTS PARTICLES

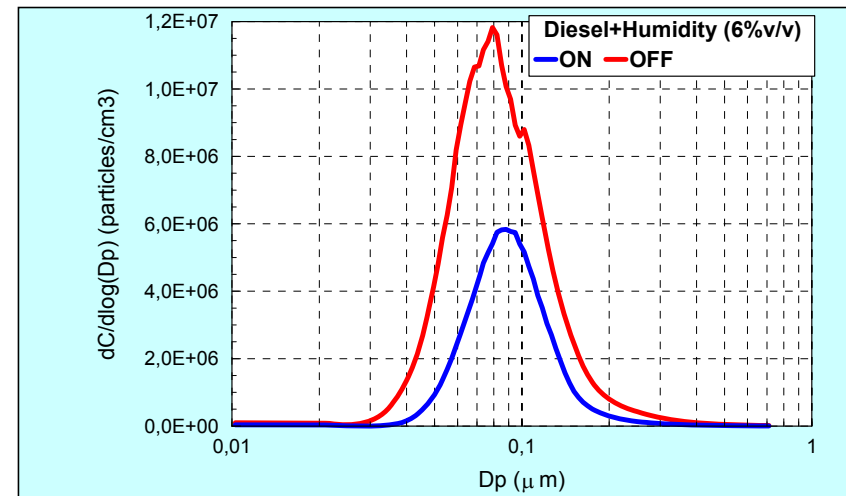
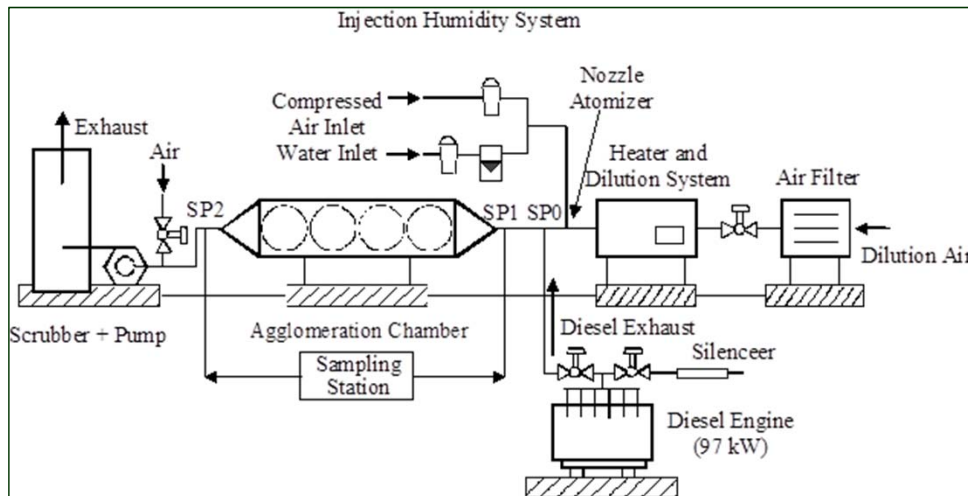

González, I., et al., (2002) *Acta Acustica united with Acustica*, 88, 19-26.
González, I., et al., (2003) *J Aerosol Sci.*, 34, 1611-1631
Riera, E., et al., (2003) *Ultrasonics*, 41, 277-281.
Riera, E., et al., (2006) *Ultrasonics Sonochemistry*, 13, 107-116.

Ultrasonic Field 4Tx400W

<SPL> = 151 dB at 21 kHz

Submicron particles

$\eta = 25\% \rightarrow 57\%$



**PASSIVE AND ACTIVE SYSTEMS ON SEVERE ACCIDENT SOURCE
TERM MITIGATION
FP7-FISSION-2012
COLLABORATIVE PROJECT**

Partners: IRSN (France), CIEMAT (Spain), CSIC (Spain), EDF (France), PSI (Switzerland), RSE (Italy), VTT (Finland), AREVA (Germany) and UniLor (France)

**WP4: INNOVATIVE FILTRATION SYSTEMS
WP4.1 (ACOU): Acoustic Agglomeration Systems
(CSIC – CIEMAT)**

PASSAM Project

WP4: INNOVATIVE FILTRATION SYSTEMS WP4.1 (ACOU): Acoustic Agglomeration Systems (CSIC – CIEMAT)

OBJECTIVE

To investigate the performance of an acoustic agglomerator system at lab-scale under conditions as close as possible to those prevailing under containment venting

- To adequately design, develop, set-up and integrate an acoustic agglomeration system (MSAA, Mitigative System Acoustic Agglomerator) in the PECA-PASSAM facility.
- To measure the aerosol growth and/or precipitation in the MSAA.
- To find out the best operational conditions of the acoustic agglomeration system to work with aerosols taken as a model of those present in accident scenarios.

2D Ultrasonic Field Patterns Inside the AA Chamber (Measurements)

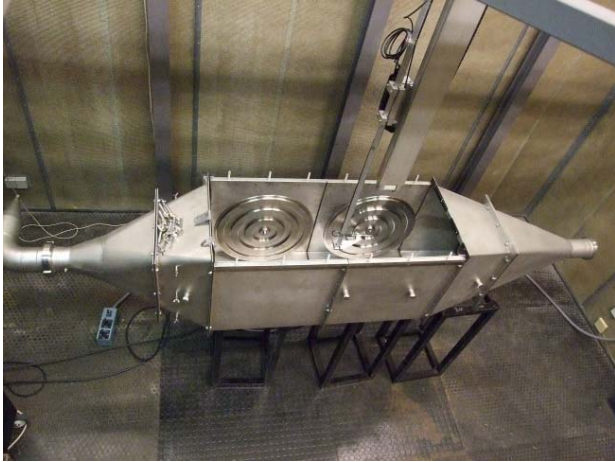
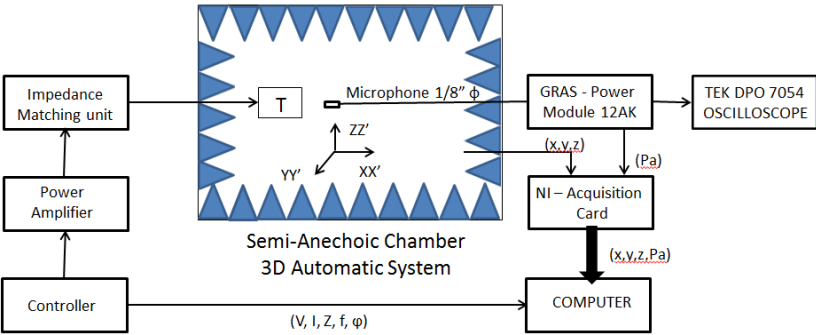

Top view

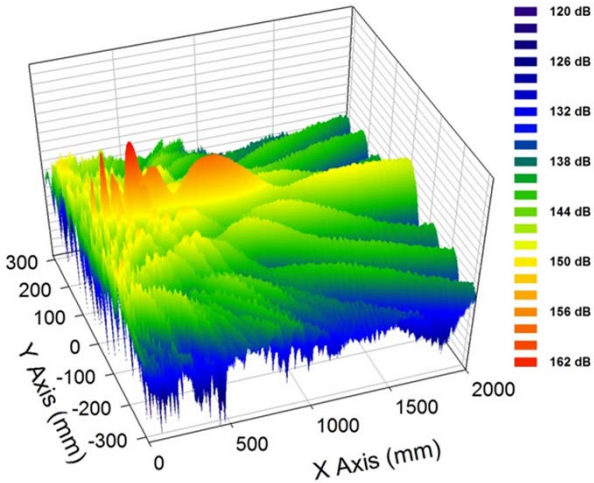

MSAA - Mitigative System - Acoustic Agglomerator (CSIC)

It is a system to induce particle agglomeration through the application of high intensity ultrasonic waves through the aerosol.

The system basically consists of:

- i) A modular acoustic agglomeration chamber
- ii) 2 stepped-plate power ultrasonic transducers
- iii) A power electronic generators

Main characteristic of the system

Acoustic frequency = 21 kHz

Sound threshold for AA > 140 dB

<SPL> inside MSAA = 155dB (measured)

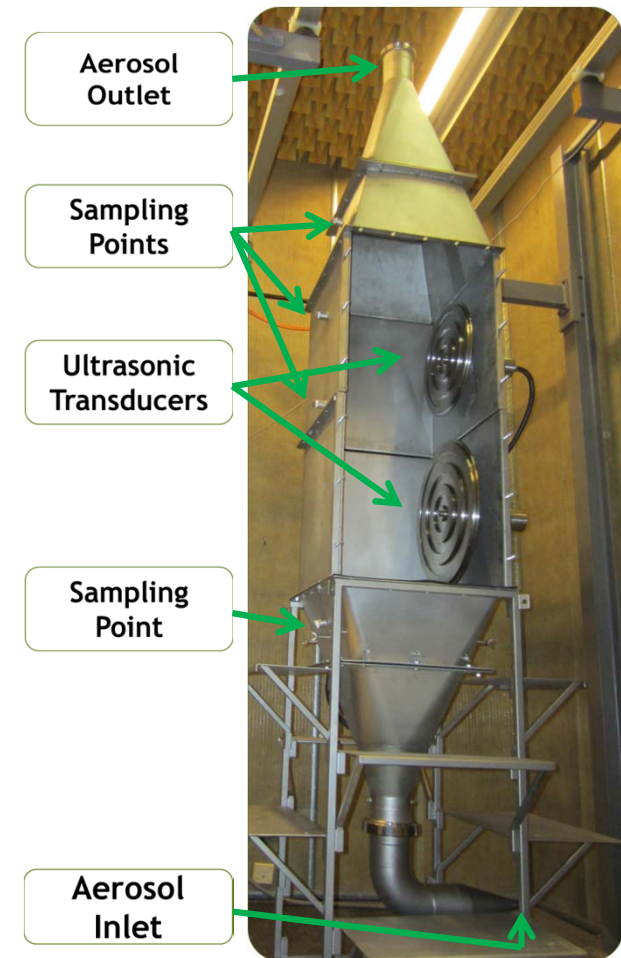

Full facility PECA-MSAA-PASSAM

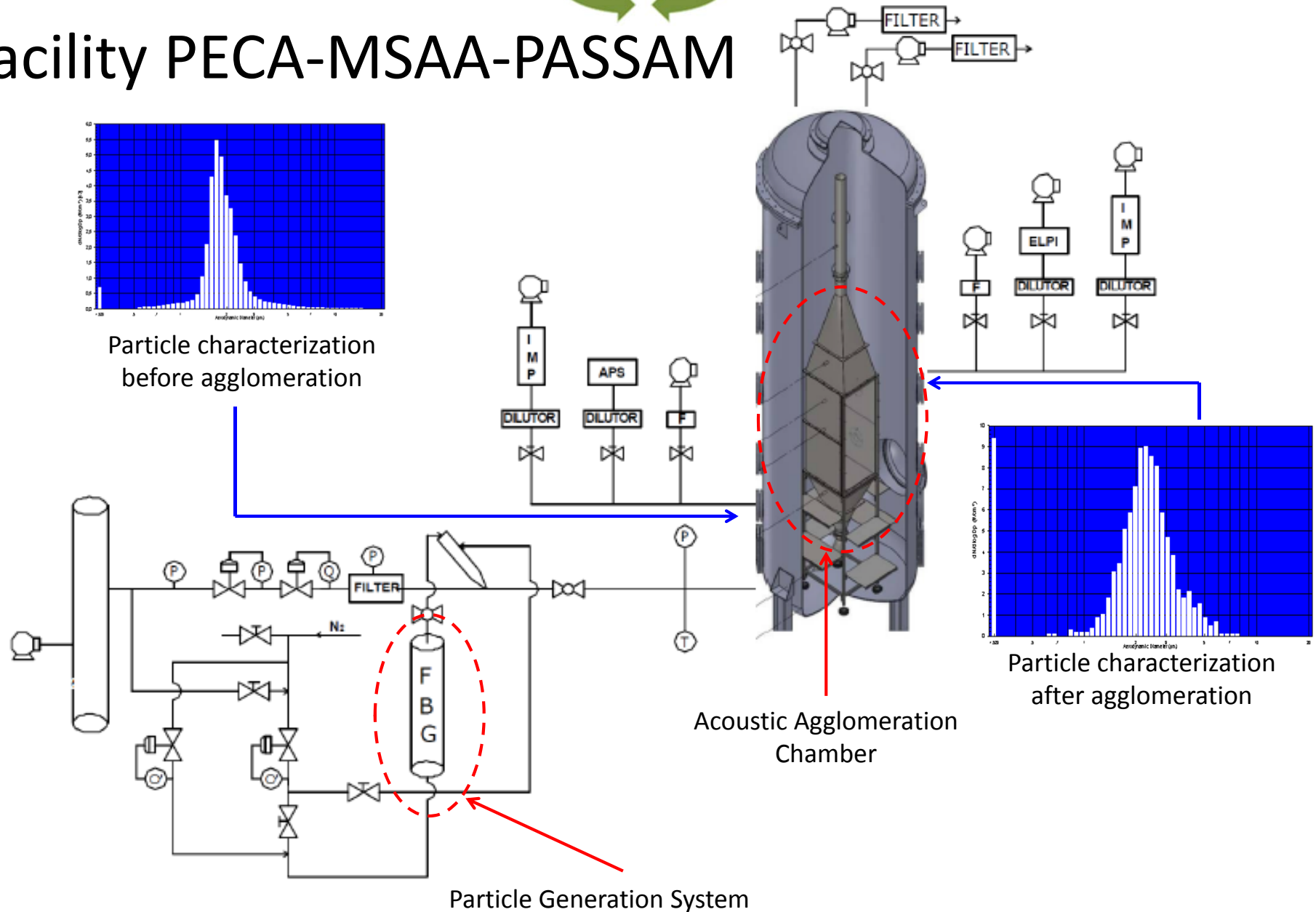

Conclusions

- Two innovative systems for ultrasonic application in DGE at pilot plant scales (5L and 20L) were implemented and validated experimentally
- The new systems confirm the high effect of the application of ultrasonic energy in DGE processes with supercritical CO₂. Improvements up to 90% and 40% were obtained in almond-oil and cocoa cake-oil extraction yields, respectively.
- It has been proved that PU are effectively transmitted along the extraction Vessel
- Acoustic agglomeration of aerosols is a process that involves the response of particles suspended in gaseous media to forces arising from an intense sound field
- Orthokinetic collisions and the hydrodynamic mechanisms, in particular the acoustic wake effect, may be considered the dominant effects
- The main practical application for acoustic agglomeration is industrial gas cleaning (power plants, electric arc steelmaking, nuclear power plant accidents, etc.)
- This technique has been shown as a form of filtration especially suitable for the removal of very small particles by increasing the size of submicron particles to the size where can be collected by electrical or inertial methods