

# Moving Towards a Hydrogen Future

## Cardinal Energy Consulting

Fola Olanrewaju Ayoola, Kiran Prakash Chawla, Tapas Peshin, Madalsa Singh, Sindhu Sreedhara

*2020 USAEE Case Competition*



## Contents

Executive Summary .....	4
0. Future Demand Scenarios .....	5
1.1. Background .....	5
1.2. Country Specific Demand .....	5
1.2.1. Spain: A push for Transportation.....	5
1.2.2. Italy - A Robust Hydrogen Economy .....	6
1.2.3. France – First Mover’s Advantage .....	7
1.2.4. Portugal – Hydrogen for Economic Recovery .....	7
2. Estimation of Emissions.....	9
2.1. Steam Methane Reforming .....	9
2.2. Steam Methane Reforming with CO2 capture and storage .....	10
2.3. Electrolysis with wind energy .....	11
2.4. Electrolysis with solar energy .....	11
2.5. Sensitivity Analysis.....	12
2.6. Uncertainty Analysis .....	13
3. Levelized costs of hydrogen production .....	15
3.1. Grey hydrogen .....	15
3.2. Blue hydrogen .....	15
3.3. Green hydrogen.....	15
3.4. Cost forecasts .....	16
3.4.1. Technology learning rates .....	16
3.4.2. System loss impacts.....	17
3.5. Cost analysis.....	18
3.6. Other Factors.....	18
4. Climate Damages .....	19
4.1. Scenario 1: National, low .....	20
4.2. Scenario 2: National, high .....	20
4.3. Scenario 3: Global accounting, medium .....	20
4.4. Scenario 4: Global accounting, high.....	20
5. Results .....	22
5.1. Spain.....	23

5.2.	Italy .....	24
5.3.	Portugal .....	25
5.4.	France .....	26
5.5.	Emissions results.....	26
6.	Appendix.....	28
6.1.	Appendix A: Hydrogen LCA Details .....	28

## Executive Summary

Most of the current policy support for hydrogen deployment in the world has been in passenger cars, vehicle refueling stations, buses, decentralized electrolyzers, trucks, followed by building heat and power, power generation and industry. For the four countries of interest for our clients - France, Portugal, Italy and Spain - each country can develop a comprehensive strategy of hydrogen production, demand end uses, and mode of production. A thorough survey and results are given in this report. Of the countries surveyed and analyzed, Italy and France are uniquely poised to take advantage of the hydrogen economy given the favorable combination of policies and geography leading to a robust demand.

Currently, the comparative levelized costs of hydrogen favor fossil-fuel based or grey hydrogen given existing regulation. This outlook changes into the future given increasing natural gas prices and the significant contribution of fuel cost to grey hydrogen LCOH. Technology strides, learning-by-doing efficiency improvements and technology transfer will bring electrolyzer costs down, given that over 60% of costs result from capital charges. In the lowest-cost case, green hydrogen from either solar PV or wind becomes competitive in the 2030s. However, supply losses which approach 45% present system integration challenges, limiting the value of hydrogen in industry, particularly as a substitute for cheap natural gas. Regardless, hydrogen remains a viable alternative in the power sector, since the benefit of the supply chain substituting transmission lines, particularly with increased renewables penetration, outweighs these costs.

It is determined that from the life cycle emissions and climate change perspective, water electrolysis with 50% wind and 50% solar energy (green hydrogen) is the most efficient in the current scenario. This is followed by SMR with carbon capture and storage and SMR, respectively. We also determine that greater the percentage contribution of wind on the grid, lower are the GHG emissions compared to a grid with majority solar energy. We find that steam methane reforming with 100% carbon capture and storage produces lower emissions than electrolysis performed with 100% solar energy.

Whether countries decide to internalize global externalities or limit their national policies to account for sovereign economic effects has a big influence on the optimal mix of hydrogen technologies. Therefore, assumptions on the future of carbon pricing will significantly influence investment decisions and the resulting portfolios.

We present least cost investment portfolios for the four countries. In all cases, portfolios begin by picking grey hydrogen and switch to green hydrogen when the cost of producing green hydrogen falls below that of grey hydrogen. This depends, in part, on the social cost of carbon projections for each country. Countries which have higher costs for carbon switch to green hydrogen faster than the others. Notably, blue hydrogen does not feature in any of our portfolios as the cost premium of performing carbon capture and sequestration is never outweighed by the cost of carbon. Uncertainty analysis shows that the portfolio is sensitive to the price of natural gas, as this affects the cost of grey and blue hydrogen.

# 1. Future Demand Scenarios

## 1.1. Background

Hydrogen is currently already a part of the industrial refining, manufacturing of ammonia, methanol, and steel. It is light, storable, energy-dense, and has no direct combustion related emissions. Currently, hydrogen usage is completely absent in transport, buildings, and power generation. To increase future adoption in these sectors, drastic infrastructure, manufacturing, and technology strides will need to be made. For transport, adoption of fuel cell cars depends on costs of fuel cells and the refueling network whereas trucks would need a lowered delivered price of hydrogen. Current natural gas supply network in buildings can be blended with hydrogen for multifamily and commercial buildings, both as liquified end product or through pipelines. For power generation, we can store renewable energy, hydrogen, and ammonia for power system flexibility.

Hydrogen is currently almost completely supplied by fossil fuels, and the demand has grown 3X with major end uses in refining (38.2 MT in 2018), ammonia manufacturing (31.5 MT in 2018), and for other purposes (4.2MT in 2018)<sup>1</sup>. With evolving technology and engineering solutions, hydrogen supply and production have new business opportunities - big, centralized production or small, decentralized production - which our clients can diversify to.

## 1.2. Country Specific Demand

### 1.2.1. Spain: A push for Transportation

Spain's main push for hydrogen production is through in Hydrogen Fuel Cell Electric Vehicle (HFCEV) which need deployment of Hydrogen Refueling Stations (HRS) which can be deployed on site. The hydrogen production can take place at industrial places or at Hydrogen Refueling Stations (HRS)<sup>2</sup>. Unlike other fuels, hydrogen can be produced on site in the HRS, requiring only electricity and water. This avoids the extraction, refining and distribution stages of fossil fuels and, in addition, retains value creation in the regional area of influence. In this way, by guaranteeing a supply of renewable energy, the whole cycle of hydrogen is zero emission.

This is part of Spain's mobility plans such as the 2017 Movalt Plan which earmarks 35m euros for the advancement of new mobility. The National Framework of Alternative Energies in Transport which directly incentivizes hydrogen use in transport puts current business volume in Spain at 594m currently and expected to be 2200m euro by 2030. As of Dec 2016, Spain's plan included a network of 20 HRS by 2025 out of which only 6 have been installed as per 2020<sup>3</sup>

However, significant regulatory bottlenecks exist in Spain for established and new entrants of hydrogen manufacturing, especially for decentralized production through HRS. There are no incentives or differences in zoning and placement requirements of green hydrogen or hydrogen produced through electrolysis compared to status-quo production of hydrogen through Steam Methane Reforming - i.e. production of hydrogen in HRS is currently permitted only in special earmarked 'industrial zones' which can make transport refueling difficult.

Spain has largely focused hydrogen strategy on the transportation sector with focus on HRS. Currently 6 HRS in Spain produce 7200 kg/day of hydrogen which will be ramped up to 20 HRS producing 24000 kg/day. Our outlook for Spain for massive expansion of the hydrogen economy is weak and difficult without explicit clarity on regulations on decentralized production.

### 1.2.2. Italy - A Robust Hydrogen Economy

Greenhouse gas emissions in Italy have reduced at a rate of 0.7% per year due to the combined effect of increased energy efficiency, greater source of renewable energy sources, and delocalization of industrial production. Decarbonization efforts are mostly guided by *Piano Nazionale Integrato per l'Energia e il Clima* (PNIEC), and the country represents a good test bed for the hydrogen economy - from pasta factories to hard-to abate sectors<sup>4</sup>. Like Spain, Italy has its eye on transportation, especially for heavy-duty trucks, ships, but can also expand to integrate expected renewables of 32 GW of solar and 9 GW of wind until 2030, heating existing buildings, and as feedstock for fertilizers and petrochemicals. Italy sits at the sweet geographic spot to have ample renewable resources in wind and sun in the south, robust demand centers in North, and existing pipeline network which connects to North Africa<sup>5</sup>. According to analysis by SNAM, an Italian energy infrastructure company, hydrogen could provide almost one quarter of all energy in Italy by 2050. In a 95% decarbonization scenario (needed to reach 1.5 degree threshold), hydrogen could supply as much as 23% of its total consumption by 2050. This evolution pathway used in our models is given below:

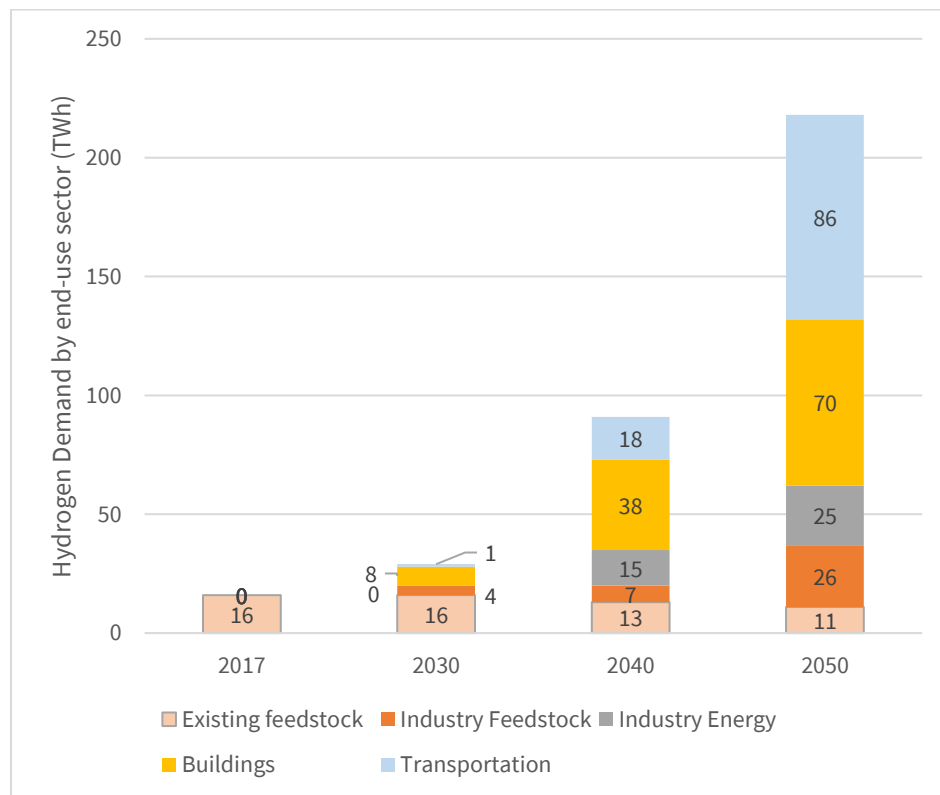

Figure 1 Projected Energy Demand Supplied with Hydrogen in Italy

### 1.2.3. France – First Mover’s Advantage

French companies are among the biggest hydrogen producers and distributors worldwide with a strong presence in the materials and component supply chain for fuel cells, automotive, and fertilizer industry. As per France’s decarbonization objectives (Plan Climat, 2 degree scenario), hydrogen could amount to 20% of final energy demand in 2050 and reduce annual CO2 emissions by ~55 million tons. Our modeled scenarios combine data from Hydrogen Council, Association Française pour l’Hydrogène et les Piles à Combustible (AFHYPAC), and scenarios from Plan Climat.

France’s focus on transportation can reap rewards with their existing manufacturing and skills in their automotive and supplier industries. Up to 400 hydrogen refueling stations, 200,000 fuel cells vehicles, early adoption of public transport fueled by hydrogen can help the harder to decarbonize areas of transport. Like a lot of other countries, blending hydrogen in natural gas network, input into feedstock, industry heat are other low-hanging fruits. Crucially, France can incorporate their nuclear heavy grid to expand electrolysis capacity to 0.8-1 GW<sup>6</sup>.

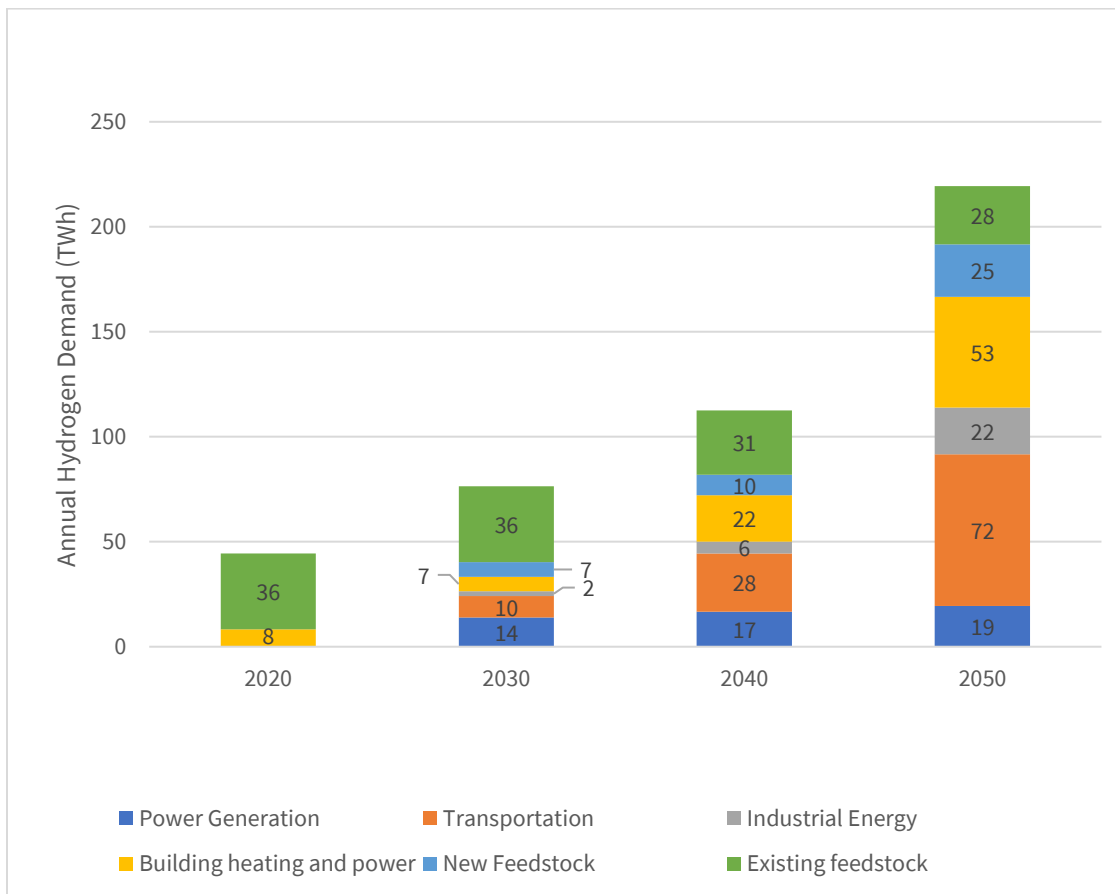

Figure 2 Projected Energy Demand Supplied with Hydrogen in France

### 1.2.4. Portugal – Hydrogen for Economic Recovery

Portugal released its hydrogen strategy aimed at post-Covid economic recovery for the country as part of the EN-H2 (Estratégia Nacional para o Hidrogénio) objectives. It ties together Portugal’s stimulus program with it’s a projected emissions reduction of 45-55% by 2030 as part of National Energy and

Climate Plan 2021-2030 (PNEC 2030). The country’s strategy also includes launch of a POSEUR call in 2020 aimed at supporting projects for the production, distribution, and consumption of renewable sources, including hydrogen with a total investment of 40 million euros from the European Recovery Fund. EN-H2 is ambitious, and beyond the existing agreements, is closely linked to European Green New Deal and post-Covid recovery signaling massive policy push and financial fluidity <sup>7</sup>Portugal’s strategy for 2030 is summarized below:

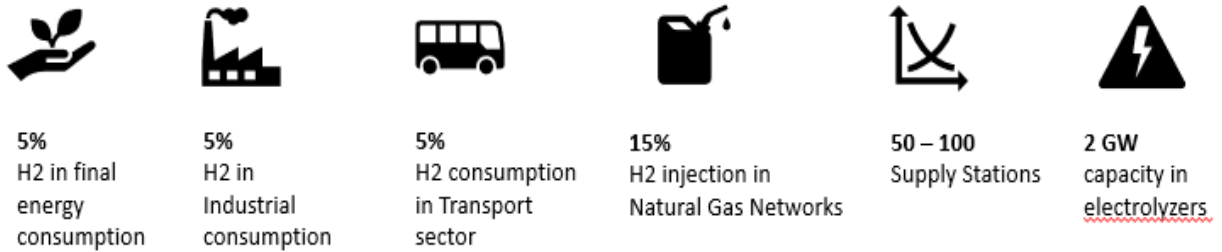

Figure 3 Portugal's EN-H2 Objectives for 2030

Considering individual countries’ climate agreements, regulations, and national hydrogen frameworks, we built the following demand curve through a compounded annual growth rate as given below:

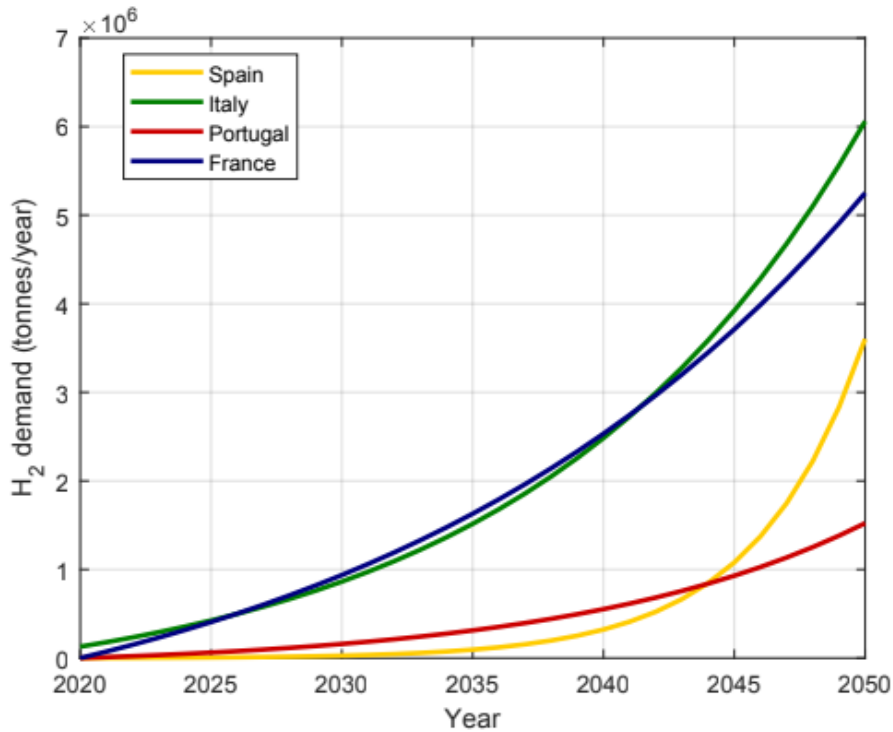

Figure 4 Demand Curve for Hydrogen till 2050



## 2. Estimation of Emissions

Life cycle assessment (LCA) is an analytical method that provides an assessment of the environmental impacts of the considered products and technologies from a “cradle to grave” systems perspective, utilizing the detailed input and output parameters that operate within the designated system boundaries. A comprehensive LCA is performed for three methods of hydrogen production. These include steam methane reforming (grey hydrogen), steam methane reforming with carbon capture and storage (blue hydrogen) and water electrolysis with wind and solar energy (green hydrogen). Fig. 1. shows the system boundaries associated with each methodology used in the study.

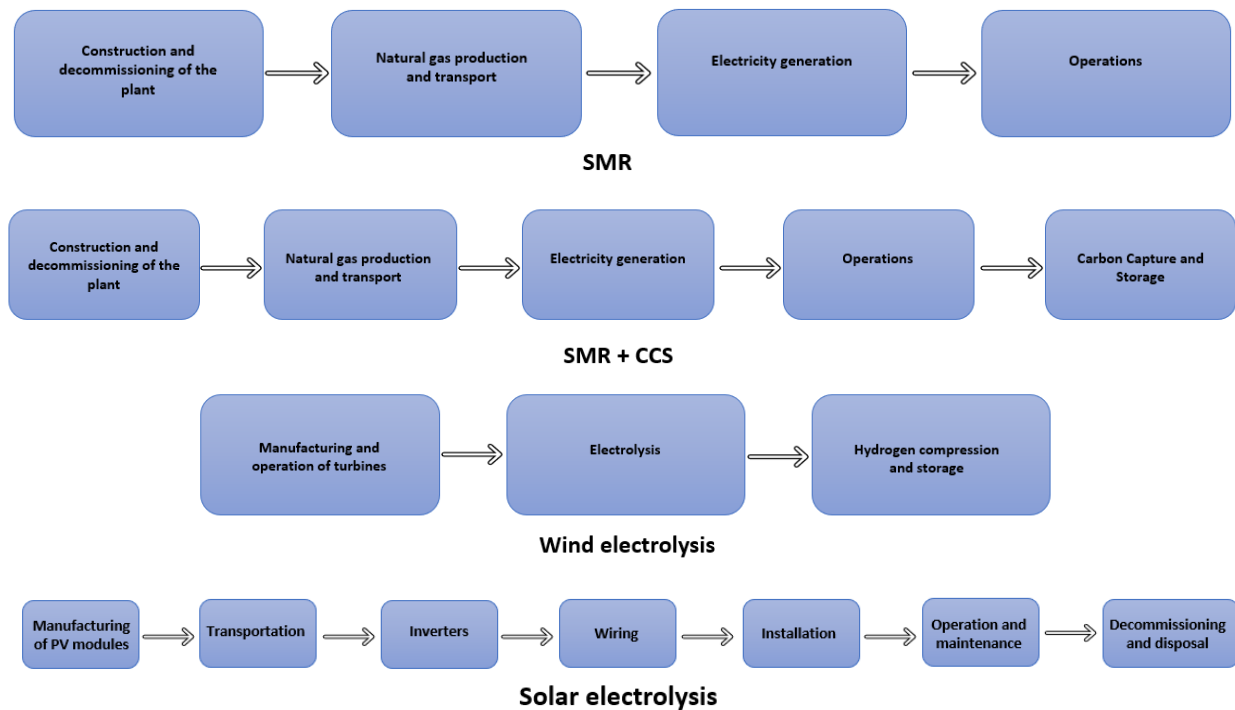

Figure 5 Study system boundary of life cycle greenhouse gas emissions. SMR = Steam methane reforming; SMR + CCS = Steam methane reforming with carbon capture and storage; Wind electrolysis = Water electrolysis with wind energy; Solar electrolysis = Water electrolysis with Photovoltaic solar energy.

### 2.1. Steam Methane Reforming

Modern, large-scale hydrogen plants that use natural gas as a feedstock are the primary means of meeting the growing demand of hydrogen. Natural gas is used as both feed and fuel. The natural gas stream is split, and the majority is used as process feed, which is compressed and desulfurized before entering the reformer reactor tubes. The natural gas used as fuel is mixed with pressure swing adsorption (PSA) tail gas and combusted within the reformer furnace to provide the energy required to drive the reforming reactions. Gas leaving the reformer enters a high-temperature shift reactor, where carbon monoxide (CO) is reacted with steam to produce additional hydrogen. After cooling, hydrogen-rich gas from the shift reactor is processed by a PSA unit for purification to product hydrogen specifications. The PSA tail gas, consisting of unreacted methane, CO, nitrogen, and unrecovered

hydrogen, is recycled for mixing with natural gas and used as fuel in the reformer furnace. Appendix A shows the flow diagram for the operations in a hydrogen plant.

Table 1 shows the energy equivalent and CO<sub>2</sub> equivalent emissions from the construction and decommissioning of the plant, natural gas production and transport and electricity generation in the steam methane reforming life cycle stages. The Global warming potential for CH<sub>4</sub> and N<sub>2</sub>O are 28 and 265, respectively.<sup>8</sup>

Table 1:  
Energy and carbon dioxide emissions<sup>9</sup>

Process	Energy equivalent (KJ/kg H <sub>2</sub> )	Emissions (g/kgH <sub>2</sub> )			
		CO <sub>2</sub>	CH <sub>4</sub>	N <sub>2</sub> O	CO <sub>2</sub> equivalent
Construction and decommissioning of the plant	159600	41.85	0	0	41.85
Natural gas production and transport	4150	299.18	59.8	0	1973.58
Electricity generation	1910	261.53	0	1.06	542.43

Table 2 shows the sources and carbon dioxide equivalent emissions associated with the operations stage of the steam methane reforming process. We make the assumption that the plant produces 100 mmscf of hydrogen per day. Also, it is assumed that 1 mmscf of H<sub>2</sub> produced is approximately equivalent to 2363 kg.

Table 2:  
SMR Operation emissions<sup>1</sup>

Source	CO <sub>2</sub> e (short tons/day)
Complete conversion of feed to H <sub>2</sub>	1485
Combustion of fuel to provide reforming energy	420
Combustion of fuel to provide export steam	290
Power for separation and compression	10

This results in approximately 8465 g/kg of H<sub>2</sub> produced from the operation stage and total carbon dioxide equivalent emissions of 11.02 kg.

## 2.2. Steam Methane Reforming with CO<sub>2</sub> capture and storage

Praxair<sup>1</sup> white paper shows various steps at which CO<sub>2</sub> can be captured and stored in the hydrogen production plants as shown in Appendix A. We make the assumption that post combustion capture is used and 90% of the CO<sub>2</sub> is captured for the base case scenario. The efficiency penalties associated with capture technologies vary significantly. The chemical solvent commonly used in the absorption column is Monoethanolamine (MEA). The CO<sub>2</sub>-rich absorbent is then pumped to the desorber and heated more than 100 °C to recover the CO<sub>2</sub> which is dried and compressed up to 100–150 bar to be transported and injected into the storage location. The capture and storage process requires important electricity consumptions compared to conventional SMR. Several technological options have been developed in the last few years to reduce energy penalty and improve environmental feasibility of CO<sub>2</sub> capture and storage. For this study, we estimate efficiency losses of 5% points<sup>10</sup> for the H<sub>2</sub>/CO<sub>2</sub> separation section which have been accounted for in the natural gas production and transportation process.

Table 3 shows the emissions associated with initial stages of the life cycle.

Table 3:  
Energy and carbon dioxide emissions<sup>3,4</sup>

Process	Energy equivalent (KJ/kg H <sub>2</sub> )	Emissions (g/kgH <sub>2</sub> )			
		CO <sub>2</sub>	CH <sub>4</sub>	N <sub>2</sub> O	CO <sub>2</sub> equivalent
Construction and decommissioning of the plant	159600	41.85	0	0	41.85
Natural gas production and transport	4357.5	314.139	62.79	0	2072.259
Electricity generation	1910	261.53	0	1.06	542.43

Based on 90% capture assumption, we estimate the operations CO<sub>2</sub>e emissions per kg of H<sub>2</sub> produced to be 847 g. This brings the total CO<sub>2</sub>e emissions from SMR process with carbon capture and storage to be approximately equal to 3503 gCO<sub>2</sub>e.

### 2.3. Electrolysis with wind energy

The resources that are consumed at the highest rate in wind electrolysis system are iron and limestone. The iron, which is mostly used in manufacturing the wind turbines and hydrogen storage vessels, accounts for 37.4% of the resources. The large amount of limestone, 35.5% of the major resources, is used for the turbines' concrete foundations. Coal, which is consumed primarily to produce the steel, iron, and concrete, accounts for 20.8% of the remaining resources. This is followed by oil at 4.7%, and natural gas at 1.6% which are primarily used in manufacturing the wind turbines.<sup>11</sup>

Table 4 shows the emissions associated with water electrolysis using wind energy.

Table 4: Energy and carbon dioxide emissions<sup>5,12</sup>

Process	Energy equivalent (KJ/kg H <sub>2</sub> )	Emissions (g/kg H <sub>2</sub> )						
		CO <sub>2</sub> %	CH <sub>4</sub> %	N <sub>2</sub> O %	CO <sub>2</sub>	CH <sub>4</sub>	N <sub>2</sub> O	CO <sub>2</sub> equivalent
Manufacturing and operation of turbines	6606.6	78%	92%	67%	741.0	7.7	8.9	757.6
Electrolysis	436.8	4%	3%	6%	38.0	0.3	0.8	38.0
Hydrogen compression and storage	2875.6	18%	5%	27%	171.0	0.4	3.6	171.0

The total GHG emissions associated with electrolysis using wind energy is estimated to be about 967 kgCO<sub>2</sub>e.

### 2.4. Electrolysis with solar energy

Energy consumed during manufacturing of PV modules contributes to about 76% of the total consumption. This is followed by operation and maintenance which contributes to about 7%. Appendix A shows the operational steps associated with hydrogen production by electrolysis using solar energy.

Table 5 shows the energy equivalent and GHG emissions for electrolysis with photovoltaic solar energy.

Table 5:  
Energy and carbon dioxide emissions<sup>7</sup>

Process	Energy Equivalent (KJ/kg H <sub>2</sub> )	CO <sub>2</sub> e emissions (gCO <sub>2</sub> e/kg H <sub>2</sub> )
Material and manufacturing of PV modules	25,550.5	1,940.2
Transportation	602.5	589.1
Inverters	830.9	141.6
Wiring	602.4	76.9
Installation	2,679.7	47.5
Operation and maintenance	2,285.0	205.8
Decommissioning and disposal	893.2	78.8

From the above discussions, we estimate the total and direct GHG emissions for the three methodologies used in the report to be as shown in Fig. 5. For the base electrolysis case, we make the assumption that the 50% of the electricity comes from wind and remaining 50% comes from solar energy using photovoltaics.

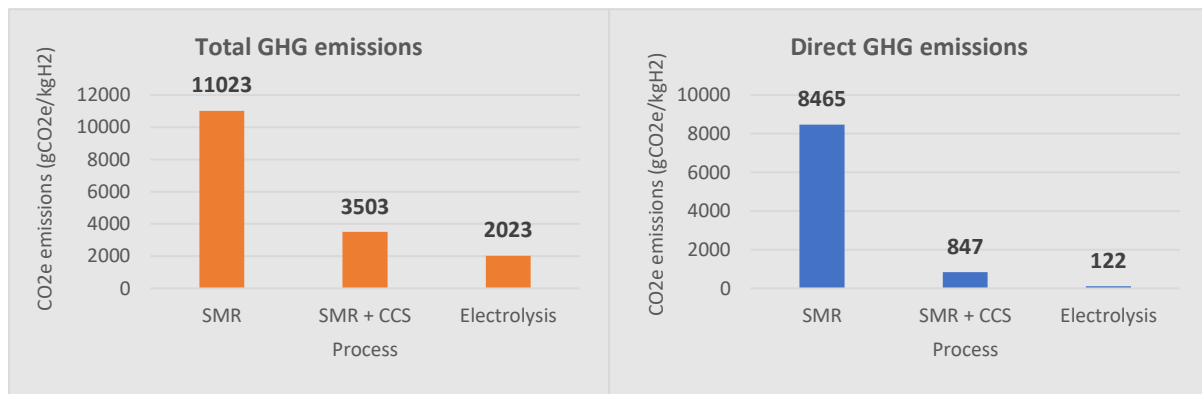

Figure 6 Total and Direct GHG Emissions

## 2.5. Sensitivity Analysis

Electrolysis with renewable energy is assumed to be 50% from solar and 50% from wind. We take different grid mixes for the scenarios used in sensitivity analysis for green hydrogen production. Table 6 shows the four scenarios taken in the report.

Table 6: Green hydrogen production sensitivity inputs

	Solar	Wind	Total GHG	Direct GHG
Base case	50%	50%	2023	122
Scenario 1	0%	100%	967	38
Scenario 2	25%	75%	1495	80
Scenario 3	75%	25%	2552	164
Scenario 4	100%	0%	3080	206

For the sensitivity analysis for steam methane reforming with carbon capture and storage, we take four scenarios for capture percentages using chemical solvent through absorption. Table 7 shows the scenarios used in this report.

Table 7:  
Blue hydrogen production sensitivity inputs

	CCS%	Total GHG	Direct GHG
Base case	90%	3503	847
Scenario 1	80%	4350	1693
Scenario 2	85%	3926	1270
Scenario 3	95%	3080	423
Scenario 4	100%	2657	0

## 2.6. Uncertainty Analysis

For steam methane reforming based on the Praxair white paper report, we make the assumption that the upper estimate of GHG emissions from the operational phase is about 2500 short tons/day as provided in the report. This makes the higher estimate for SMR to be about 9.6 kgCO<sub>2</sub>e/kg of H<sub>2</sub> produced. The lower estimate is based on the assumption that methane fugitive emissions are negligible and the combustion of fuel to provide export steam is also zero. Table 8 shows the lower, central and upper total and direct GHG limits for different hydrogen technologies used in the study.

Table 8:  
Uncertainty analysis GHG emissions

	Total GHG emissions			Direct GHG emissions		
	SMR	SMR+CCS	Electrolysis	SMR	SMR+CCS	Electrolysis
Lower Limit	9059	2657	967	8175	0	38
Central	11023	3503	2023	8465	847	122
Upper Limit	12156	4350	3080	9598	1693	206

Fig. 6. shows the uncertainty analysis associated with each of three hydrogen technologies used in the study : SMR (grey), SMR with CCS (blue) and electrolysis with renewable energy (green).

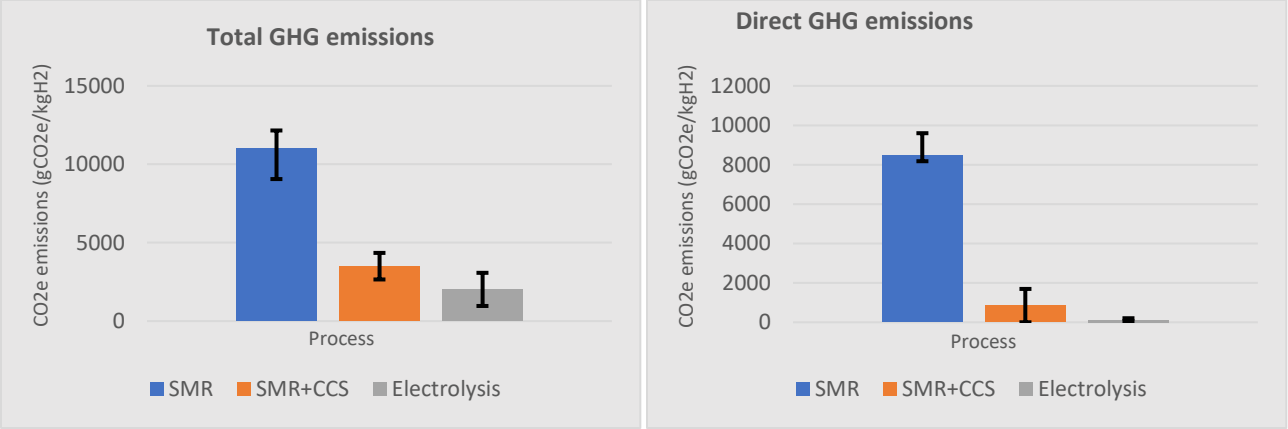

Figure 7 Uncertainty Analysis

### 3. Levelized costs of hydrogen production

The cost of production of a unit of hydrogen is dependent on not only the technology used, but also on several location-specific factors such as labor costs, electricity pricing, energy resource availability and resource variability.

#### 3.1. Grey hydrogen

The cost of investment in grey hydrogen technologies such as steam-methane reforming (SMR) and coal gasification (CG) is high, as both production methods are typically capital intensive. Investment costs in CG range from about \$600-\$1,500/kW capacity, while SMR investment costs are about half this value.

Production costs for SMR and CG are similar, in the \$0.03-\$0.05/kWh range<sup>1</sup>. A large proportion of production costs for grey hydrogen - up to 61% - are from fuel and electricity consumption, with 29% of these annual production costs resulting from capital charges, and 10% from operation and maintenance. However, there is a large range of uncertainty in reported numbers with a relative error margin of 30%, resulting from significant variability in fuel prices on the spot market, as well as in logistical costs to each location. Simple models have been proposed, which estimate SMR hydrogen production prices as functions of natural gas prices. The EIA forecasts delivered industrial natural gas prices out to 2050 to reach \$5/MMBtu (in 2019 USD), which puts SMR hydrogen costs between \$1.30/kg in 2020 and \$1.60/kg in 2050.

#### 3.2. Blue hydrogen

In assessing the cost of blue hydrogen, grey hydrogen is assumed to be coupled with carbon capture and storage (CCS), and the cost of abated carbon (CAC) is evaluated in \$/tonne CO<sub>2</sub> emissions from the fossil-fuel-based process captured. The AMEC Foster Wheeler standalone SMR+CCS facility estimates both capture cost and transport/storage costs for 90% capture rate at \$74.60/tonne CO<sub>2</sub> and \$12.40/tonne CO<sub>2</sub>. However, the cost of transport and storage is believed to be underestimated for the EU, with the European Technology Platform for Zero Emission Fossil Fuel putting estimates of storage and monitoring costs in the \$8-\$23/tonne CO<sub>2</sub> range in 2016 indices. In 2019 indices, these amount to an average cost of about \$104/tonne CO<sub>2</sub> avoided, with a lower bound in literature of about \$23/tonne CO<sub>2</sub> avoided.

#### 3.3. Green hydrogen

While the economics of green hydrogen has significantly improved over the last decade, costs remain high compared with SMR. Electrolyzer investment costs range from \$720-\$2200/kWh capacity, with uncertainty bounds of up to 20%<sup>1</sup>. Up to 40% of annual production costs of electrolyzers are associated with capital charges, with another 47% from electricity costs, and 13% from operations and maintenance. As a result, these costs vary strongly from location to location due to electricity price variations and especially electrolyzer load factors, which are usually dependent on the capacity factors of the renewables generator to which it is coupled. The impact of load factor on the levelized cost of ALK hydrogen is depicted in the figure below, with high load factors essential for the affordability of

green hydrogen<sup>i</sup>. These production costs fall in the range of \$0.04-\$0.36/kWh, with green electricity prices in the EU being as low as €0.02/kWh (\$0.03/kWh).

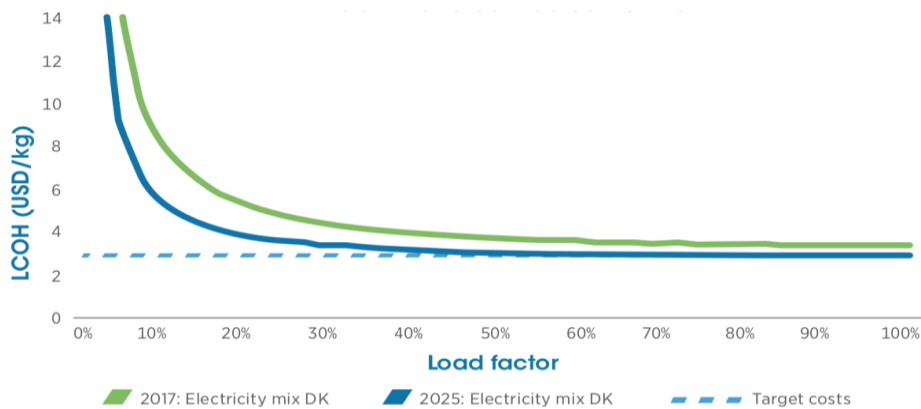

Figure 8: Impact of electrolyzer load factor on levelized hydrogen cost

### 3.4. Cost forecasts

Several factors influence cost changes over time as the hydrogen economy grows both in Europe and globally. Technology learning rates improve learning-by-doing efficiencies, and with the assumption of technology transfer, global projections of learning rates may be made, and used to make cost estimates in Europe. System cycle efficiencies and supply logistics losses also impact the cost of end-use hydrogen supply, regardless of mode of production.

#### 3.4.1. Technology learning rates

Reported technology learning rates, that is, cost reduction for every doubling in capacity by efficiency increase from learning-by-doing, are summarized in the table below. SMR+CCS carbon abatement learning rate is assumed using natural gas with CCS learning rate as a proxy (Rubin et al., 2015). Since 60-70% of costs are variable and differ by location, large uncertainties exist, making it difficult to predict actual learning rates.

Table 9: Technology learning rates

Hydrogen type	Technology	Learning rate	Uncertainty
Grey	SMR	11%	6%
Blue	SMR+CCS	4.5%	2.5%

<sup>i</sup> International Renewable Energy Agency, *Hydrogen from Renewable Power: Technology Outlook for the Energy Transition*, International Renewable Energy Agency, Abu Dhabi.



Green	Electrolysis	18%	13%
-------	--------------	-----	-----

### 3.4.2. System loss impacts

Cycle efficiencies and well as logistics supply-chain losses are important in cost evaluation, particularly for determining end-use hydrogen supply costs, and also production costs for green hydrogen, since these efficiency losses increase energy (fuel and/or electricity) consumption. Hydrogen may be delivered for end use in three forms – as ammonia, methylcyclohexane (MCH), and liquid hydrogen, depending on end-use sector and available system integration and transmission infrastructure. While hydrogen provides a good alternative to building electricity transmission, these losses are significant, making the true competitive value of electricity-to-hydrogen in long distance transport to locations which traditional transmission lines are either too expensive or infeasible to build. This value is especially significant in an electricity grid with high renewables penetration where there is a need for reducing energy curtailment, capacity requirement management and reliable storage methods.

The table below summarizes percentage losses for the aforementioned modes of hydrogen supply.

Table 10: Supply loss summary

Method	Percentage loss
Ammonia	
Power conversion	10%
Compression	19%
Electricity-to-hydrogen (electrolyzer)	16%
MCH	
Electricity-to-hydrogen (electrolyzer)	16%
Waste heat	15%
Toluene production by dehydrogenation	12%
Liquefaction	20-45% total hydrogen content lost

### 3.5. Cost analysis

Given the aforementioned considerations, projections for the levelized cost of hydrogen (LCOH) in 2019 USD per kilogram, were made by IRENA for different hydrogen production technologies, which we have adopted in this study<sup>ii</sup>. The figure below depicts cost projections for the three different forms of hydrogen technologies under consideration in our base scenario with no price on carbon emissions. The LCOH of green hydrogen presented is an average of the unit costs of wind- and solar PV-coupled ALK electrolyzer systems, with wind systems having higher unit costs than solar PV systems.

In this scenario, the least-cost green hydrogen becomes competitive against blue hydrogen (SMR+CCS) within the next couple years, while the average case green hydrogen becomes competitive against blue hydrogen by 2034. The average case green hydrogen with solar PV systems becomes competitive with grey hydrogen near 2050, while those with wind systems become so beyond 2050. In the least cost scenario however, green hydrogen becomes competitive against fossil-fuel hydrogen in the 2030s, even without a price on carbon.

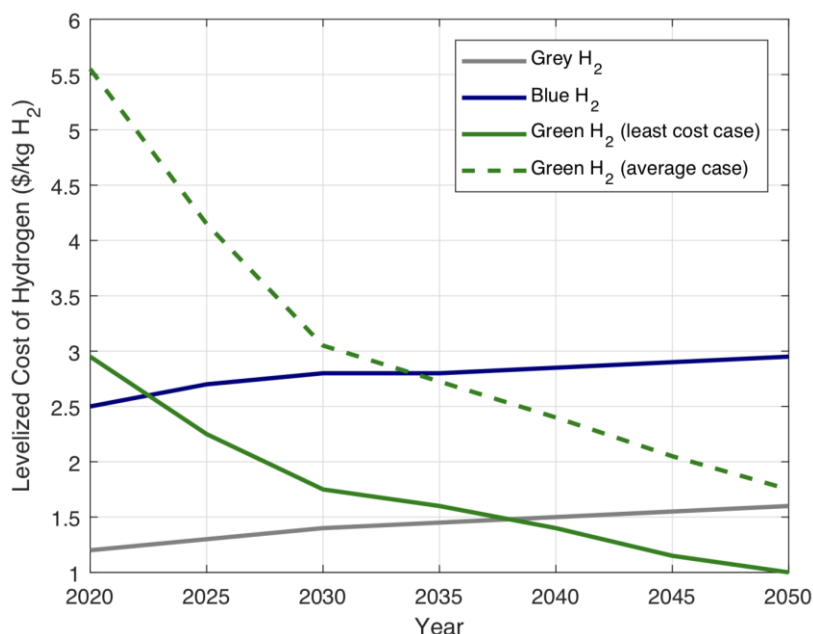

Figure 9: Hydrogen production technology cost forecast with technology transfer assumption

### 3.6. Other Factors

The cost trajectories for different hydrogen pathways (grey, blue and green) will also depend on system level factors such as the share of intermittent renewables and low carbon firm resources, as well as infrastructure investments by the national and state governments in pipelines for hydrogen transport.

<sup>ii</sup> International Renewable Energy Agency, Hydrogen: A Renewable Energy Perspective, 2019, 2<sup>nd</sup> Hydrogen Energy Ministerial Meeting, Tokyo, Japan.

By creating a range of cost trajectories, we are hoping to capture the effects of these non-technological factors on the demand and viability of different types of hydrogen.

## 4. Climate Damages

To estimate the monetized climate benefits (costs) for the hydrogen portfolios, we used a range of estimates for the social cost of carbon (SCC). The social cost of carbon is an estimate of the economic damages<sup>iii</sup> associated with a marginal change in the emissions of carbon dioxide (CO<sub>2</sub>) in a given year.<sup>iv</sup> It is therefore used in climate policy to estimate the benefits of mitigation. The social cost of carbon is estimated using either integrated assessment models (IAMs)<sup>13</sup>, econometric analysis<sup>14,15</sup>, or a combination of the two.

For our analysis, we constructed a range of scenarios to bound the estimated values of the social cost of carbon by looking at a range of plausible future scenarios as well as by varying a subset of key variables identified in the literature as important to the estimate of the social cost of carbon. The description of the scenarios and associated assumptions are provided below.

For Scenarios 1 and 2, we construct year on year trajectories to estimate the social cost of carbon for France, Spain, Portugal and Italy by using data from the Ricke et al (2018) study.<sup>16</sup> To create plausible low and high bounds, we use estimated minimum and maximum values provided for each of the countries across the five different socio-economic pathway scenarios, three representative concentration pathways (RCP), methodological variations used for estimating the damage functions and classification of countries, as well as key economic assumptions related to the social discount rate.<sup>v</sup> Because the study only estimates climate damages for a single year snapshot, we assume a fixed annual growth rate to create a time-series estimate for the 2020-2050 analysis horizon. Details for these estimates are provided in the scenario descriptions.

For scenarios 3 and 4, we use an online benefit-cost integrated assessment model called the Nested Inequalities Climate Economy (NICE) model,<sup>17</sup> which is adapted from the Nordhaus' Regional Integrated Climate Economy (RICE) model.<sup>vi</sup> This class of integrated assessment models provide year on year estimates for a global cost of carbon and have been used in the context of regulatory policy in the U.S., among other applications.<sup>vii</sup> Using the online NICE model,<sup>viii</sup> we vary the assumed value for 'inequality aversion' and the distribution of climate damages as a function of income, two factors that significantly impact the optimal climate mitigation trajectory outputs from the model.<sup>18</sup> These assumptions are elaborated on in the detailed scenario descriptions.

---

<sup>iii</sup> The economic damages could be negative, indicating a net positive economic impact for certain regions or time periods.

<sup>iv</sup> An archived version explaining the use of the SCC by the United States Environmental Protection Agency (EPA) can be found here: [https://19january2017snapshot.epa.gov/climatechange/social-cost-carbon\\_.html](https://19january2017snapshot.epa.gov/climatechange/social-cost-carbon_.html)

<sup>v</sup> The ranges for estimates for each country are obtained from the supplementary information provided with the Ricke et al (2018) study.

<sup>vi</sup> See <https://sites.google.com/site/williamdnordhaus/dice-rice> for the latest version of the models.

<sup>vii</sup> For instance, the SCC has been used in regulatory proceedings in the US. It has also been used to inform energy policy in multiple US states.

<sup>viii</sup> To access the online version of the model see: <http://climatepolicysimulator.princeton.edu/>

Using these scenarios, we are able to create a range of estimates for the climate damages associated with the portfolios developed with our model.

#### **4.1. Scenario 1: National, low**

For this scenario, we used the lowest country-level social cost of carbon estimates for France, Italy, Spain and Portugal from the Ricke et al (2018) study. The 2020 values for France, Italy, Spain and Portugal are approximately -\$32/tonCO<sub>2</sub>eq, -\$17/tonCO<sub>2</sub>eq, -\$15/tonCO<sub>2</sub>eq, and -\$2/tonCO<sub>2</sub>eq respectively. Therefore, under the most optimistic climate damages scenario from the perspective of these four countries, there are potential benefits from warming based on a 2020 snapshot when only damages within the country's borders are considered.<sup>ix</sup>

Due to the lack of information on the evolution of the social cost of carbon through time, we assume that the damages stay at that level through 2050.

#### **4.2. Scenario 2: National, high**

Like Scenario 1, we assume that only the damages within the country borders are considered. However, we use the highest estimates provided by the Ricke et al (2018) study. The 2020 values for France, Italy, Spain and Portugal are approximately \$60/tonCO<sub>2</sub>eq, \$40/tonCO<sub>2</sub>eq, \$38/tonCO<sub>2</sub>eq, and \$4/tonCO<sub>2</sub>eq respectively. To create an upper estimate, we assume that the damages grow 5% a year from the values estimated for 2020.

#### **4.3. Scenario 3: Global accounting, medium**

Using an online version of the NICE model,<sup>x</sup> we created a global climate damages scenario by making two key assumptions: the global community is sensitive to the distribution of climate damages, and that the burden of climate damages is high and falls disproportionately on the poor.

With these assumptions, a uniform global damage estimate for France, Italy, Spain and Portugal starts at \$149/tonCO<sub>2</sub>eq in 2020 and rises to \$297/tonCO<sub>2</sub>eq by 2050.

#### **4.4. Scenario 4: Global accounting, high**

Like Scenario 3, we use the NICE model to create a high damages trajectory from 2020-2050 by assuming that the mitigation burden is borne equally by all generations regardless of their wealth levels.

With these assumptions, the global uniform damages estimate starts with \$448/ tonCO<sub>2</sub>eq in 2020 and falls to \$391/ tonCO<sub>2</sub>eq as technologies enabling decarbonization fall in price.

---

<sup>ix</sup> See SI of Ricke et al (2018) study: [https://static-content.springer.com/esm/art%3A10.1038%2Fs41558-018-0282-y/MediaObjects/41558\\_2018\\_282\\_MOESM2\\_ESM.csv](https://static-content.springer.com/esm/art%3A10.1038%2Fs41558-018-0282-y/MediaObjects/41558_2018_282_MOESM2_ESM.csv)

<sup>x</sup> See online: <http://climatepolicysimulator.princeton.edu/>

The summary climate damage estimates for the four scenarios are summarized in

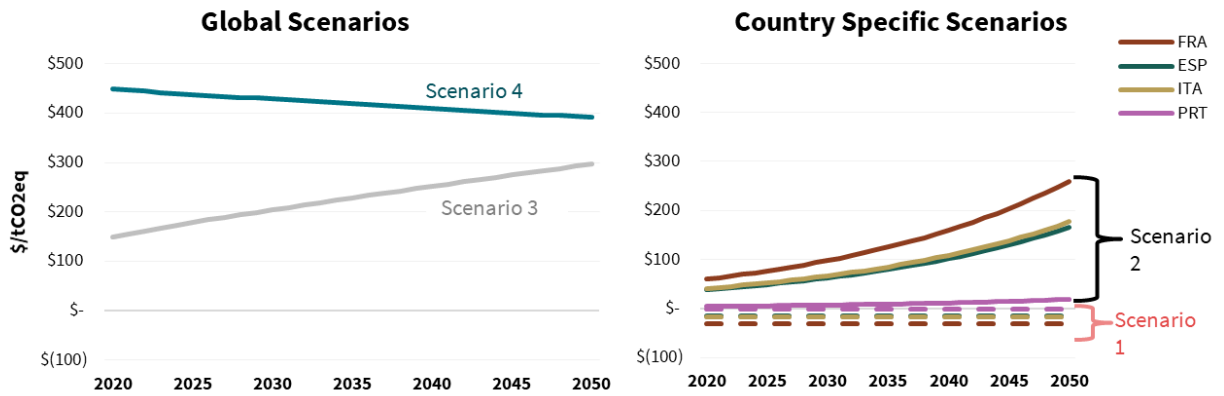

Figure 10.

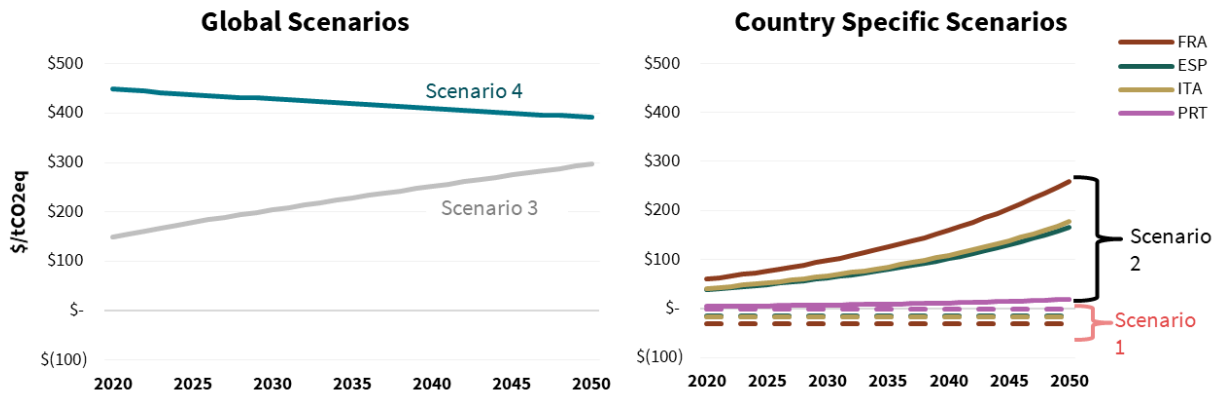

Figure 10 Summary of Climate Damages assumptions for the 2020-2050 timeframe.

## 5. Results

To develop investment portfolios for each country, we use an in-house model to perform a cost minimization over the next 30 years. For each country, our model takes the following inputs:

1. Hydrogen demand projections through 2050
2. Levelized cost of production of hydrogen
3. Carbon dioxide emissions for each production technology
4. Carbon price projections through 2050
5. Industrial discount rate

Sources for the above inputs have been discussed in previous sections. In this section, we will discuss the assumptions made in the model and present our results. We perform our analysis over the next 30 years. The assumptions we made are as follows:

1. Demand grows exponentially from 2020 to 2050.
2. In each year, the lowest cost technology for that year is chosen to meet new demand. We include a social cost of carbon as a proxy for carbon price.
3. All production technologies have a lifetime of at least 30 years. Thus, once a facility is built, it operates through 2050.
4. Direct emissions and not total emissions are while accounting for the social cost of carbon.
5. All costs are in 2019 dollars.

The following figures present our results for investing in hydrogen in the four countries. We perform an uncertainty analysis around the price of natural gas which is strongly correlated to the cost of producing grey and blue hydrogen. We use a margin of +/- 30% around the price of grey and blue hydrogen. As can be seen below, portfolios change significantly with a change in the price of natural gas.

## 5.1. Spain

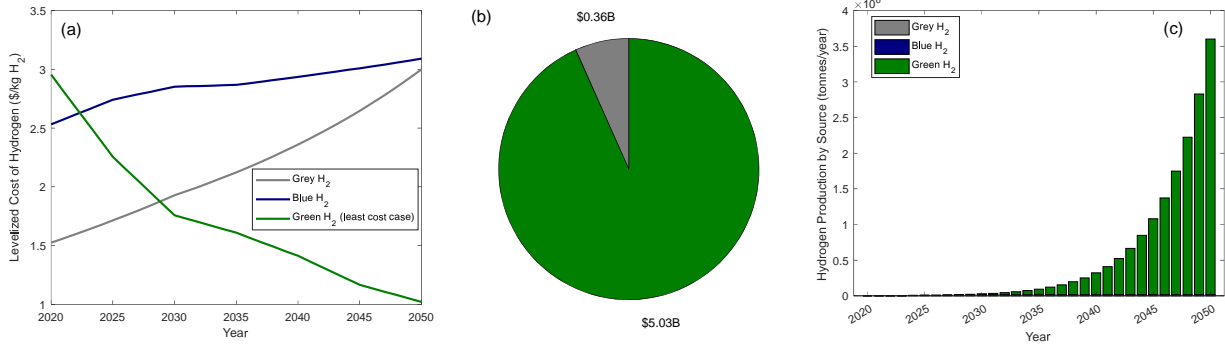

Figure 11. Levelized cost of production of hydrogen from different technologies, (b) net present value of investment into different hydrogen production technologies and (c) capacity of hydrogen produced from different production technologies over the next 30 years in Spain

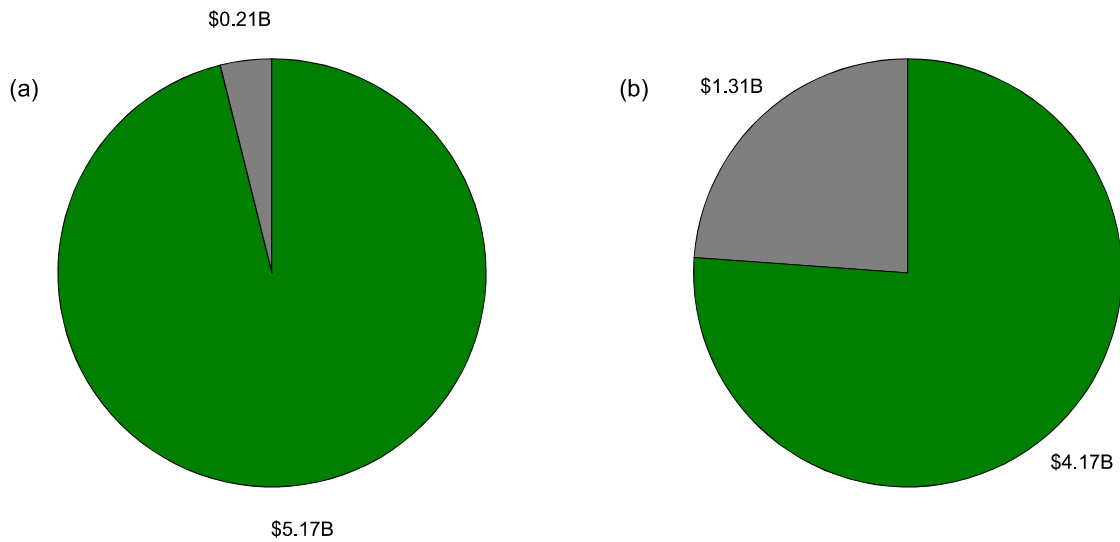

Figure 12. (a) Investment portfolio when natural gas prices are 30% higher than predicted and (b) investment portfolio when natural gas prices are 30% lower than predicted.

## 5.2. Italy

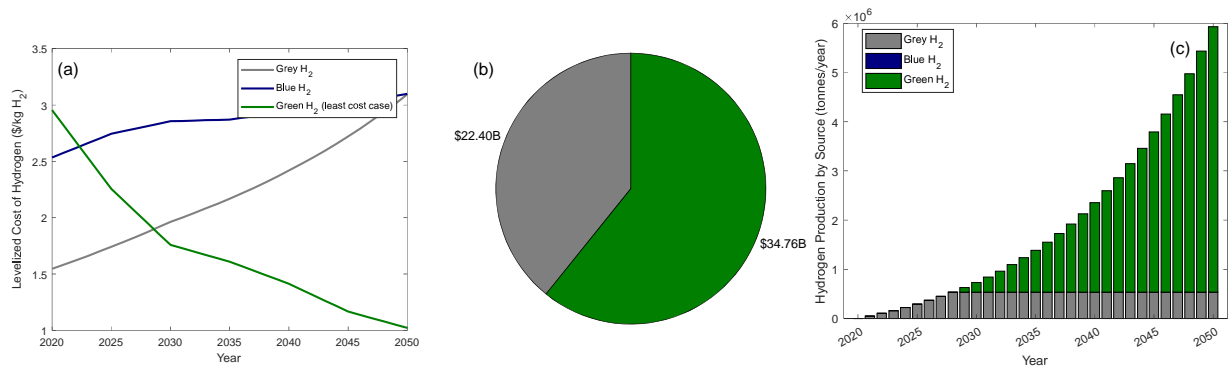

Figure 13. Levelized cost of production of hydrogen from different technologies, (b) net present value of investment into different hydrogen production technologies and (c) capacity of hydrogen produced from different production technologies over the next 30 years in Italy.

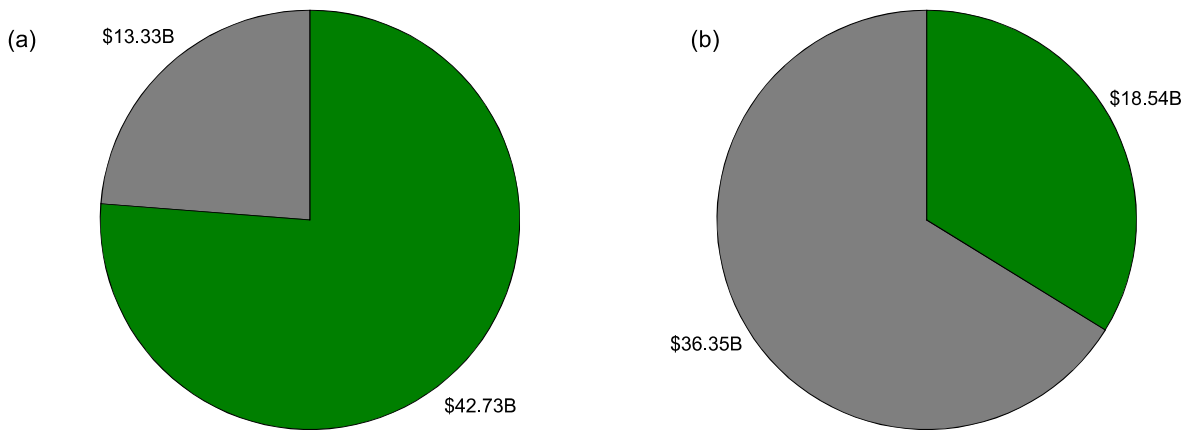

Figure 14. (a) Investment portfolio when natural gas prices are 30% higher than predicted and (b) investment portfolio when natural gas prices are 30% lower than predicted.



### 5.3. Portugal

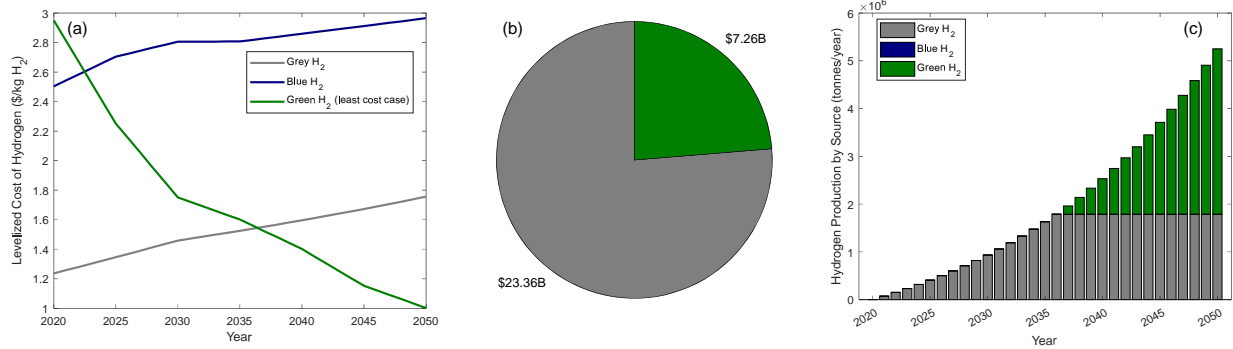

Figure 15. Levelized cost of production of hydrogen from different technologies, (b) net present value of investment into different hydrogen production technologies and (c) capacity of hydrogen produced from different production technologies over the next 30 years in Portugal.

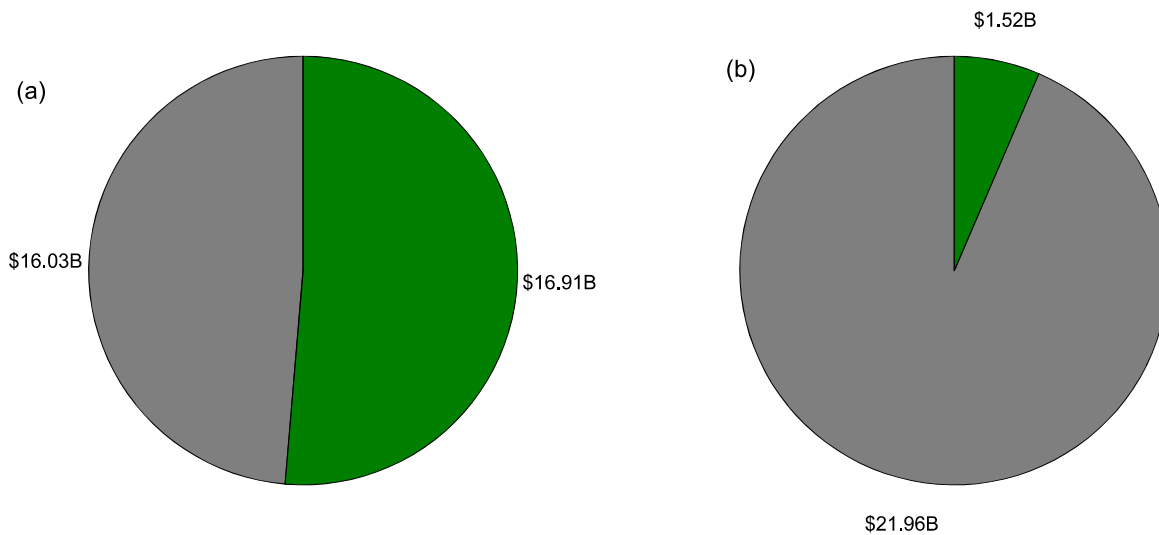

Figure 16. Investment portfolio when natural gas prices are 30% higher than predicted and (b) investment portfolio when natural gas prices are 30% lower than predicted.

## 5.4. France

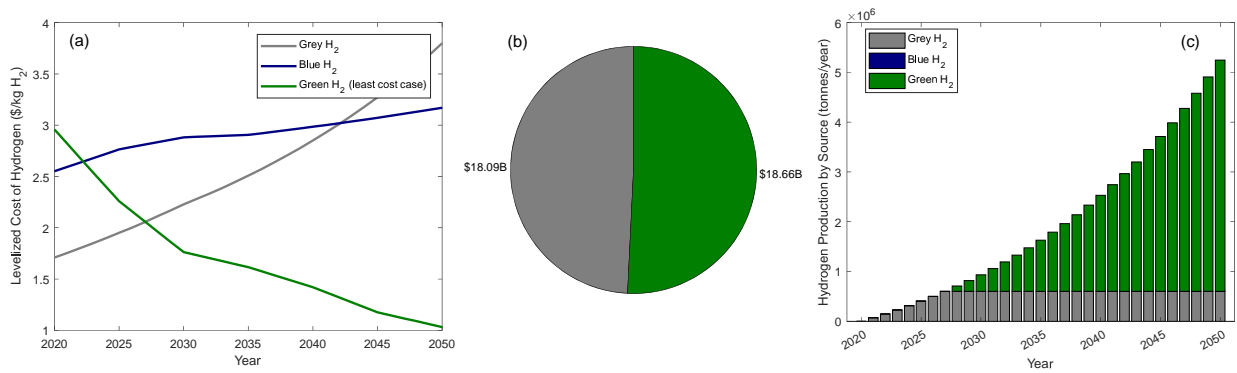

Figure 17. Levelized cost of production of hydrogen from different technologies, (b) net present value of investment into different hydrogen production technologies and (c) capacity of hydrogen produced from different production technologies over the next 30 years in France.

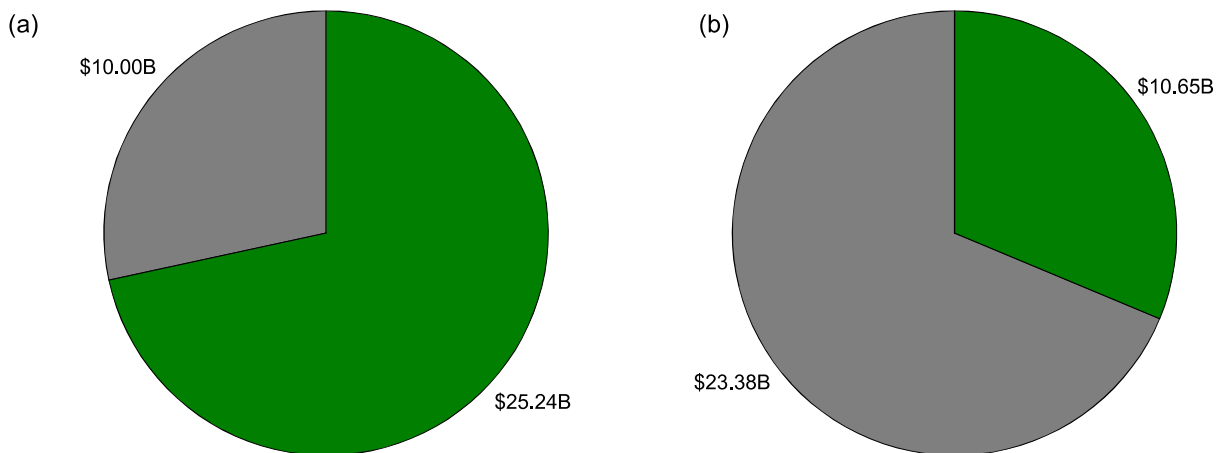

Figure 18. Investment portfolio when natural gas prices are 30% higher than predicted and (b) investment portfolio when natural gas prices are 30% lower than predicted.

## 5.5. Emissions results

In the following table we present the emissions and cost of carbon for each of our portfolios. The cost of carbon for each country depends on the projected social cost of carbon for that country and thus varies quite widely.

Table 11. Emissions from investment portfolio from each country.

Country	Spain	Italy	Portugal	France
Direct emissions (million tonnes of CO <sub>2</sub> )	3.3	124.3	327.1	142.0
Total emissions (million tonnes of CO <sub>2</sub> )	4.3	247.0	468.7	269.1
Climate cost of portfolio (billion dollars)	1.0	68.3	11.2	66.2

## 6. Appendix

### 6.1. Appendix A: Hydrogen LCA Details

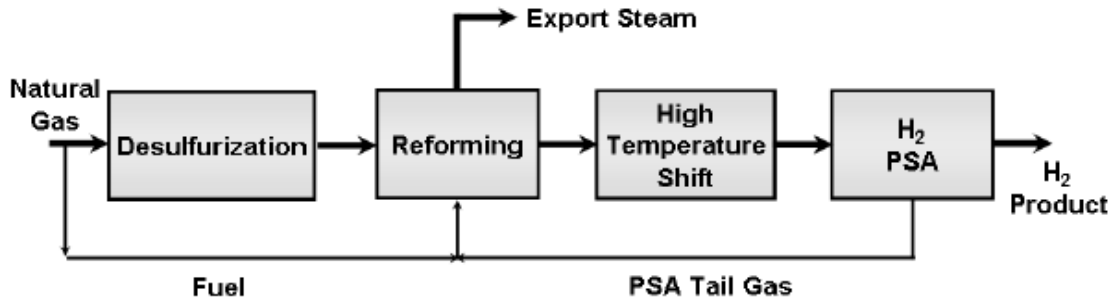

Figure 19 Hydrogen plant operational flow diagram<sup>19</sup>

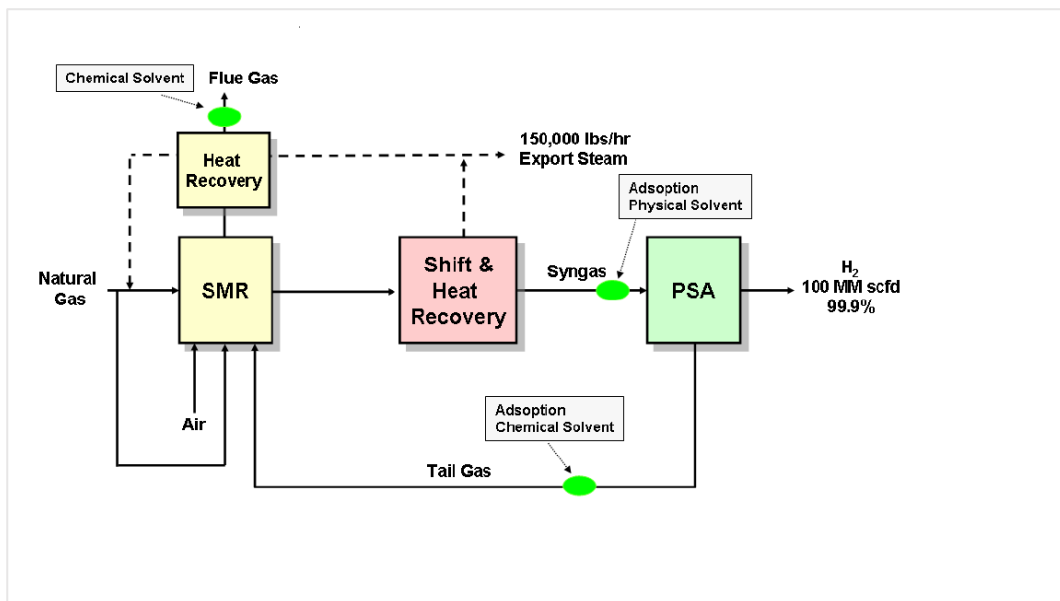
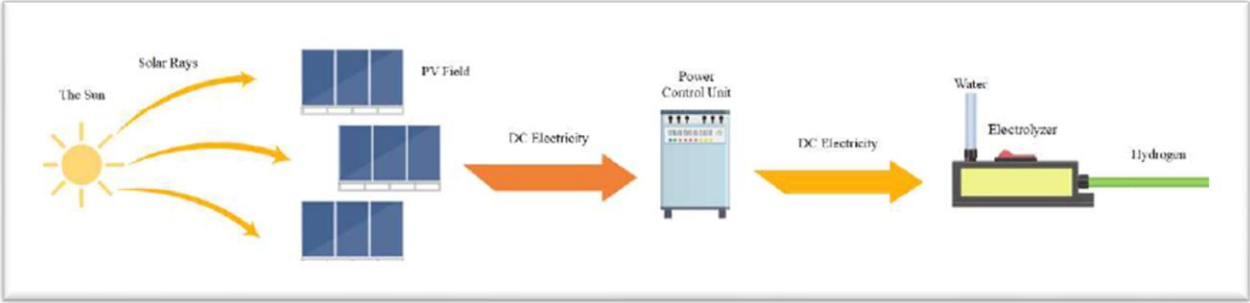

Figure 20 Hydrogen plant CCS options<sup>1</sup>

Figure 21 Electrolysis with Solar Energy



---

<sup>1</sup> IEA. (2019). The Future of Hydrogen

<sup>2</sup> HyLAW. (2019). National Policy Paper – Spain

<sup>3</sup> Manthey, N. (2017, Nov 29). Retrieved from Electrive.com: <https://www.electrive.com/2017/11/29/spain-updates-ev-policies/>

<sup>4</sup> Reed, S. (2020, May 5). Retrieved from The New York Times: <https://www.nytimes.com/2020/05/27/business/hydrogen-fuel-climate-change.html>

<sup>5</sup> SNAM. (2019). The Hydrogen Challenge : The potential of hydrogen in Italy.

<sup>6</sup> AFHYPAC. (2019). Developing Hydrogen for the French Economy - A Prospective Study.

<sup>7</sup> Energia, S. d. (2020). EN-H2 Estratégia Nacional para o Hidrogénio.

<sup>8</sup> Global Warming Potential Values. ghgprotocol.org. Retrieved from [https://www.ghgprotocol.org/sites/default/files/ghgp/Global-Warming-Potential-Values%20%28Feb%2016%202016%29\\_1.pdf](https://www.ghgprotocol.org/sites/default/files/ghgp/Global-Warming-Potential-Values%20%28Feb%2016%202016%29_1.pdf)

<sup>9</sup> Cetinkaya, E., Dincer, I., & Naterer, G. (2012). Life cycle assessment of various hydrogen production methods. *International Journal Of Hydrogen Energy*, 37(3), 2071-2080. <https://doi.org/10.1016/j.ijhydene.2011.10.064>

<sup>10</sup> Jansen, D., Gazzani, M., Manzolini, G., Dijk, E., & Carbo, M. (2015). Pre-combustion CO2 capture. *International Journal Of Greenhouse Gas Control*, 40, 167-187. <https://doi.org/10.1016/j.ijggc.2015.05.028>

<sup>11</sup> Spath, P., & Mann, M. (2004). *Life Cycle Assessment of Renewable Hydrogen Production via Wind/Electrolysis*. National Renewable Energy Laboratory. Retrieved from <https://www.nrel.gov/docs/fy04osti/35404.pdf>

<sup>12</sup> Bhandari, R., Trudewind, C., & Zapp, P. (2014). Life cycle assessment of hydrogen production via electrolysis – a review. *Journal Of Cleaner Production*, 85, 151-163. <https://doi.org/10.1016/j.jclepro.2013.07.048>

<sup>13</sup> Weyant, J. (2017). Some Contributions of Integrated Assessment Models of Global Climate Change. *Review of Environmental Economics and Policy*, 11(1), 115–137. <https://doi.org/10.1093/reep/rew018>

<sup>14</sup> Ricke, K., Drouet, L., Caldeira, K., & Tavoni, M. (2018). Country-level social cost of carbon. *Nature Climate Change*, 8(10), 895–900. <https://doi.org/10.1038/s41558-018-0282-y>

<sup>15</sup> Burke, M., Hsiang, S. M., & Miguel, E. (2015). Global non-linear effect of temperature on economic production. *Nature*, 527(7577), 235–239. <https://doi.org/10.1038/nature15725>

<sup>16</sup> Ricke, K., Drouet, L., Caldeira, K., & Tavoni, M. (2018). Country-level social cost of carbon. *Nature Climate Change*, 8(10), 895–900. <https://doi.org/10.1038/s41558-018-0282-y>

<sup>17</sup> Dennig, F., Budolfson, M. B., Fleurbaey, M., Siebert, A., & Socolow, R. H. (2015). Inequality, climate impacts on the future poor, and carbon prices. *Proceedings of the National Academy of Sciences*, 112(52), 15827–15832. <https://doi.org/10.1073/pnas.1513967112>

---

<sup>18</sup> Budolfson, M., Dennig, F., Fleurbaey, M., Siebert, A., & Socolow, R. H. (2017). The comparative importance for optimal climate policy of discounting, inequalities and catastrophes. *Climatic Change*, *145*(3), 481–494. <https://doi.org/10.1007/s10584-017-2094-x>

<sup>19</sup> Bonaquist, D. (2010). Analysis of CO2 Emissions, Reductions, and Capture for Large-Scale Hydrogen Production Plants. Praxair. Retrieved from <https://www.praxair.com/-/media/corporate/praxairus/documents/reports-papers-case-studies-and-presentations/our-company/sustainability/praxair-co2-emissions-reduction-capture-white-paper.pdf?la=en&rev=dc79ff3c7b4c4974a1328c7660164765>